



**Volkswagen**  
Beetle, Super Beetle

**Owner's  
Maintenance  
and Repair  
Guide**



**1972 Models**

## Errata

### **Pages 42, 43 and 129**

The valve clearance as listed on these pages should be changed to read 0.006 inch (0.15 mm).

### **Page 54**

The V-shaped notch in the pulley is the actual 5° After Top Dead Center mark to be used for the setting of the ignition timing. Do NOT make a mark to the left of the notch as illustrated (top illustration) and described in paragraph b.



**Volkswagen**

**Beetle, Super Beetle**

**Owner's  
Maintenance  
and Repair  
Guide**

© 1971 Volkswagen of America, Inc.  
All rights reserved

All information contained in this booklet is based on the latest product information available at the time of printing. The right is reserved to make changes at any time without notice.

## Introduction

The Beetle and Super Beetle are unique cars in many ways. Surely, one way must be that they seem to invite tinkering.

Partly, this comes from the very personal feeling owners have toward their VW's. More than just transportation; they are, for many, a part of the family.

But also, this willingness to pick up a screw driver and "do it yourself" comes from the simple, uncluttered design of the cars themselves.

They are easy to get at. And owners who might normally consider a spark plug a potential antagonist, will check distributor points or change a coil at the sound of an engine cough.

This book is to keep them, and you, out of trouble — and to make maintaining a Volkswagen not only a little less expensive, but a little more fun.

Perhaps you have no intention of ever lifting a finger over your car's engine. This book is still for you, because it can tell you a lot about your VW you might never normally have known. And should you ever need help, you will be able to quote chapter and verse to someone else.

But before you start any of the maintenance tasks, repairs, or adjustments described in this booklet, be sure to read the chapter on Preparation.

You'll want to choose the right tools and gather the essential materials before you start your job. And you'll also want to read the instructions carefully and keep the book open before you as you progress through each step.

We've tried to limit the tasks in this book to those easily performed and requiring few tools. But what is easy for your neighbor (who stuffs V-8 engines into old VW's) may not be easy for you.

That's where your Authorized VW Dealer comes in. You may enjoy changing a tail light; but you may prefer to have your dealer tune the carburetor. In fact, unless you are quite certain of your skills, we might suggest you ask your dealer to perform tasks especially related to safety, like brake repairs or adjustments.

He's also the man to turn to for Volkswagen tools and Volkswagen spare parts. And, remember there's only one place to get a VW Diagnosis — especially the four free ones that come with the car. And that, too, is at your dealer's. Have your car diagnosed according to schedule and you can be sure no little, hidden problems will grow to haunt you as big, expensive ones.

### A FEW WORDS ABOUT WORDS.

Throughout the book you will find paragraph headings such as NOTE, CAUTION, or WARNING. A NOTE contains information you'll want to make note of before starting the job. A CAUTION points out information you'll need to prevent you from damaging your car. And a WARNING points out information you'll need to prevent you from damaging yourself. Please, take heed.

As we have suggested, understanding and caring for your Volkswagen should deepen your relationship with it. And that, really, is the reason for providing you with this guide.

## Table of Contents

<i>Chapter</i>	<i>Title</i>	<i>Page</i>
1	Preparation and Tool List .....	1
2	Troubleshooting .....	4
3	Tune Up .....	12
4	Jacking and Supporting .....	14
	Left Side with Both Wheels Off the Ground .....	16
	Right Side with Both Wheels Off the Ground .....	15
	Jacking Either Side with Support Stand Under Front and Rear .....	16
5	What Should Be Done Regularly .....	18
	Maintenance .....	18
	Lubrication .....	19
	Engine .....	21
	Checking Engine Oil Level .....	25
	Transmission .....	25
	Transmission – Automatic Stick Shift .....	28
	Air Cleaner .....	29
	Front Axle .....	32
	Door and Hood Locks .....	34
	Battery .....	36
	Spark Plugs .....	39
	Valve Clearance .....	41
	Ignition Distributor .....	45
	Distributor Contact Breaker Points .....	47
	Condenser .....	50
	Dwell Angle Check and Adjustment .....	52
	Ignition Timing Procedure .....	53
	Carburetor Idle Speed Adjustment .....	55
	Throttle Valve Positioner .....	55
	V-Belt .....	57
	Fuel Pump Filter .....	60
	Clutch Pedal Free Play .....	61
	Exhaust Muffler .....	62
	Tail Pipes .....	69
	Steering Damper (Beetle) .....	70
	Steering Damper (Super Beetle) .....	73

<b>Chapter</b>	<b>Title</b>	<b>Page</b>
	Shock Absorbers .....	76
	Brake Fluid Reservoir .....	78
	Windshield Washer .....	78
6	General Service .....	80
	Electrical System .....	80
	Bulb Replacement .....	89
	Headlights .....	90
	Headlight Assembly .....	91
	Front Turn Signal/Parking Light or Side Marker Light Bulbs .....	93
	Front Turn Signal and Parking Light Assembly .....	94
	Rear Turn Signal, Stop and Tail Light or Back-up Light Bulbs .....	95
	Tail Light Assembly .....	96
	License Plate Light Bulb .....	98
	Interior Light .....	98
	Fuses .....	99
	Windshield Wiper Blades .....	101
	Windshield Washer Spray Jets .....	103
	Checking Tire Condition .....	103
	Wheels .....	105
	Front Seats .....	109
	Rear Footwell Heating .....	110
	Front Bumper .....	112
	Rear Bumper .....	113
	Rubber Molding for Bumpers .....	114
	Front Fenders .....	115
	Rear Fenders .....	117
	Running Board .....	118
7	Beauty Care .....	120
8	Accessories .....	123
9	Technical Data .....	129



# Chapter 1

## Preparation and Tool List

Before going into details there are several general rules you will want to consider.

First, be careful. Carelessness can cause injury to yourself and damage to your car or personal property. Second, remember that incorrect servicing will change the performance of your car. It may also change the effectiveness of the exhaust emission control or may otherwise impair the safety and dependability of your Volkswagen.

### **To prevent injury to yourself, follow these rules:**

- Never work under the car unless it is on support stands.
- When working under the car, make sure it is on level ground, has the wheels blocked and the engine cannot be started.
- Be alert and cautious around the engine while it is running.
- Never run the engine unless the area is well ventilated.
- Tie long hair back behind your head.
- Dress for the occasion, do not wear neckties or loose clothing.
- Remove all jewelry.
- When working around fuel, never smoke or have anything in the area that can ignite the fuel. Keep a fire extinguisher in close reach.
- Do not store fuels, oils, or cleaning fluids in food containers.
- When working on the fuel system or electrical system, always disconnect the battery. Keep a fire extinguisher in close reach.

### **To prevent damage to your car or personal property, follow these rules:**

- Always use only the proper replacement parts which can be obtained from your Authorized VW Dealer.
- Always use the proper tools.
- If you do not have the proper tools or have doubts whether you can do the repair or adjustment yourself, have it done by your dealer or by a qualified mechanic.
- Be sure you have adequate lighting when working on any part of the car.
- Follow the instructions in this booklet very closely. Do not try to short-cut them.
- Use containers to catch any drained or spilled fuel or oil. Spilled oils and fuels create a fire hazard and are especially damaging to asphalt surfaces. Be sure to wipe up spills immediately.
- Be careful how you dispose of your oil. Do not discard it in streams, down sewage drains, or on garden soil. Check your local ordinances.

## Tool List

The following is a list of tools needed to do the work in this book. The figure in parentheses indicates the number needed.

- |   |   |
|---|---|
| <ul style="list-style-type: none"> <li>*1. Open end wrenches: 8 mm, 10 mm, 13 mm (2), 17 mm, 19 mm</li> <li>*2. Offset box wrenches: 10 mm, 13 mm</li> <li>*3. Box wrenches: 7 mm, 10 mm, 13 mm, 19 mm, 21 mm</li> <li>4. a. Sockets: 10 mm, 15 mm, 17 mm, 19 mm, 21 mm, <math>\frac{7}{16}</math> inch (12 point spark plug socket, <math>\frac{3}{8}</math> inch drive)</li> <li>      b. Extensions 2 <math>\frac{1}{2}</math> and 6 inches, <math>\frac{3}{8}</math> inch drive</li> <li>      c. Sliding T-handle (8 inches long maximum), <math>\frac{3}{8}</math> inch drive</li> <li>      d. Ratchet, <math>\frac{3}{8}</math> inch drive</li> </ul> | <ul style="list-style-type: none"> <li>5. Torque wrench: 0 to 150 foot-pounds, <math>\frac{3}{8}</math> inch drive</li> <li>6. Phillip's screwdrivers: No. 1 (with magnetic tip), No. 2, No. 3</li> <li>7. Screwdrivers (flat blade type): <math>\frac{1}{8}</math> inch, <math>\frac{7}{16}</math> inch, <math>\frac{3}{8}</math> inch</li> <li>8. Pliers, insulated handles</li> <li>9. Tire pressure gauge</li> <li>10. Wire type thickness gauge with bending lever, 0.020, 0.024, 0.028 inch</li> <li>11. Flat type feeler gauge, 0.004, 0.016 inch</li> <li>12. Hex head wrench: 17 mm</li> </ul> |
|---|---|

\*These tools are sold in combination such as 8 mm on one end and 10 mm on the other end.

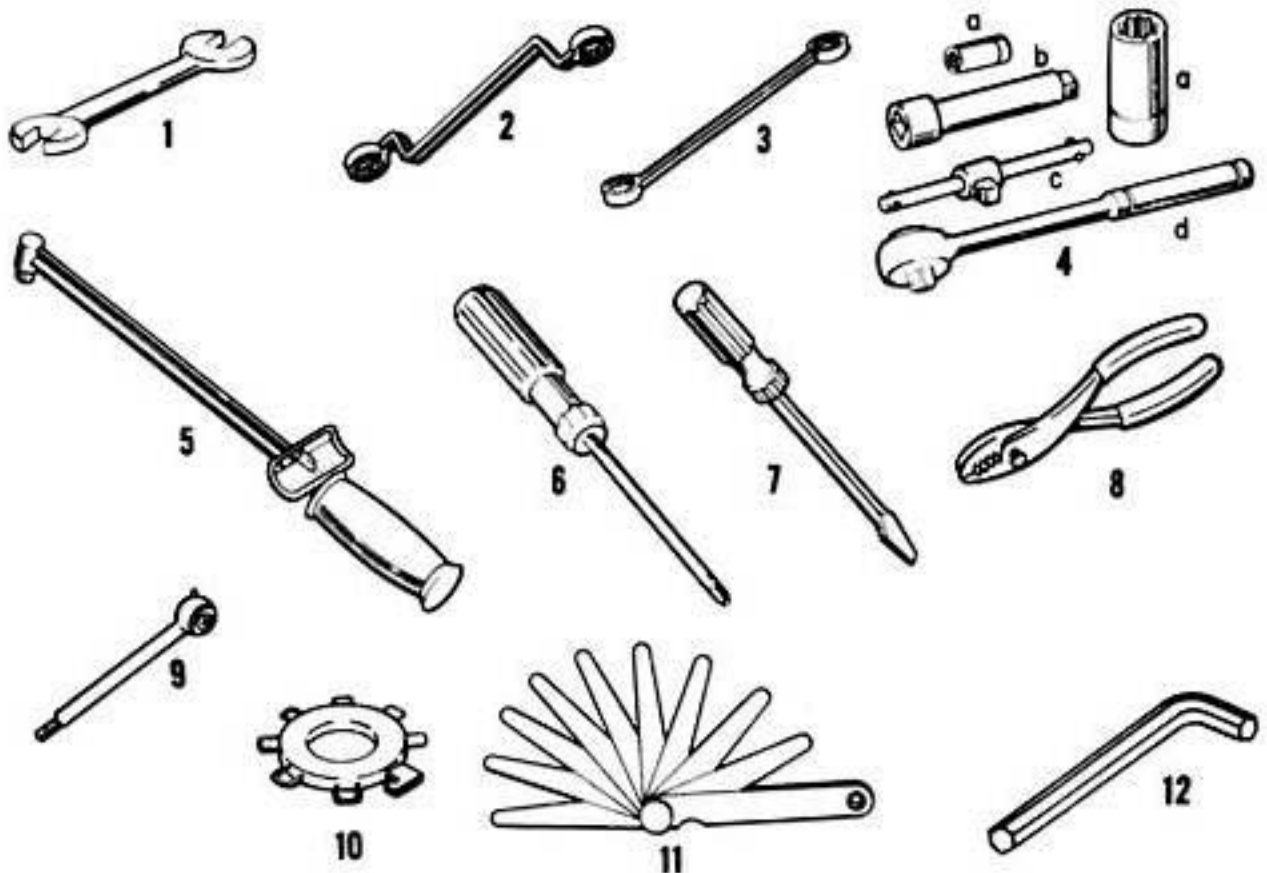

13. Combination instrument or dwell meter, tachometer, and stroboscopic timing light

14. Hand oil can

15. Hand grease gun

16. Oil can opener/spout

17. Support stands, 11 inches high when lowered (2)

18. Drift pin  $\frac{1}{4}$  inch

19. Funnel, plastic

20. Offset screwdriver (flat blade type)

21. Clamp, fuel line

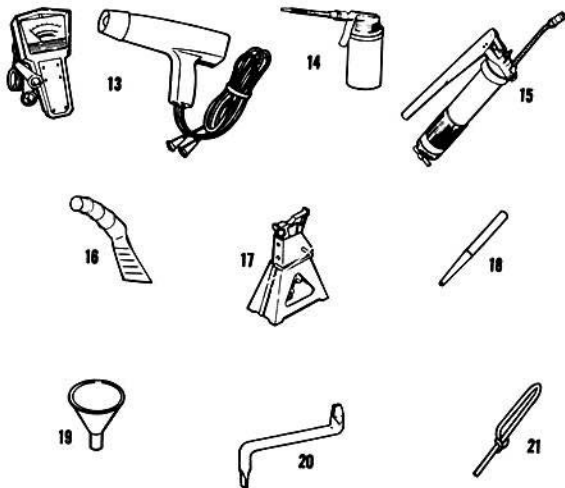

# Chapter 2

## Troubleshooting

These troubleshooting procedures have been developed to help you find and correct some of the most common problems. They will take you step by step to the most likely causes. If, after making the checks, the trouble has not been found and corrected you should take your car to your Authorized Volkswagen Dealer.

### 1. Engine Will Not Turn Over or Turns Over too Slowly to Start

- a. On cars with Automatic Stick Shift, make sure the gear shift lever is in Neutral.
- b. Turn on headlights and check that they are bright. If not, go to step f. If bright, go to step c.

#### NOTE

The starter is located beside the right rear wheel well. It may be necessary to remove the wheel to get at the starter.

#### WARNING

If it is necessary to raise the car, follow the jacking procedures in Chapter 4, Jacking and Supporting, page 14. Do not work under the raised car without support stands.

- c. Check the electrical connections at the starter. Tighten any loose connections. Clean any dirty connections.

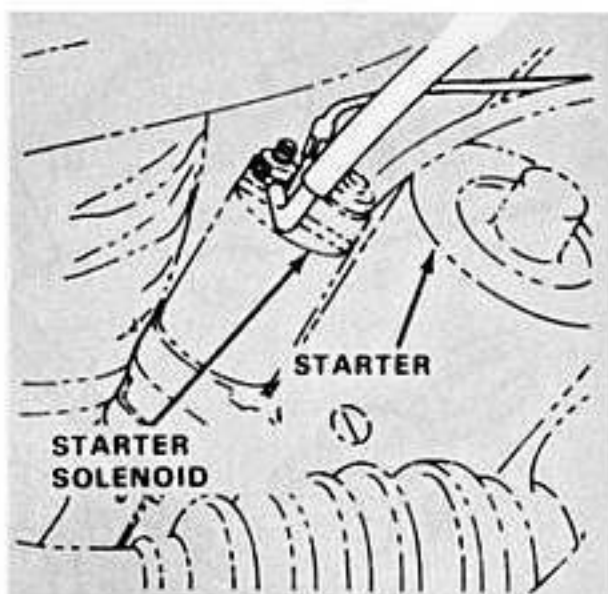

- d. Try to start the car. If car will not start, check push-on connections behind instrument panel. The connections are accessible by removing hard board cover in front of luggage compartment. If the connections are loose, tighten them.

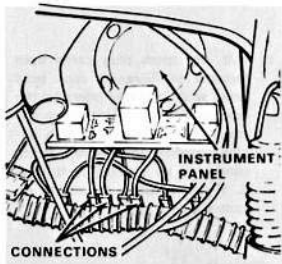

- e. Try to start the car. If car will not start, have battery charged.
- f. Check the connections at the battery and the ground connection to the body. Tighten any loose connections. Clean any dirty connections.
- g. Try to start the car. If the car will not start, have battery charged.

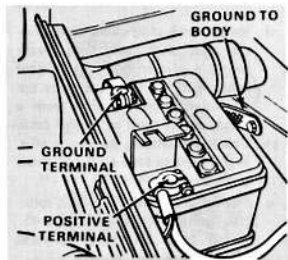

## 2. Engine Turns Over But Will Not Start

- a. Check your gas gauge. Add gas as needed.
- b. Check for loose connections at coil, distributor, and spark plugs. Tighten any loose connections. Try to start the car. If car will not start, go to step c.

### WARNING

Be extremely careful of fire. If you see or smell fuel, ventilate and dry area. Remove fuel soaked rags to safe area.

Be very careful when working around engine when it is running. Remove any neckties or necklaces. Tie long hair back behind your head.

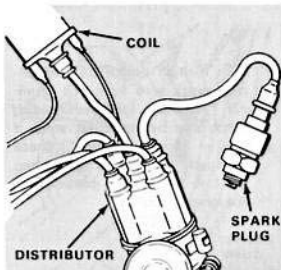

- c. Pull any spark plug cable from terminal of distributor cap. Hold cable with insulated pliers by the insulation about  $\frac{1}{4}$  inch from terminal of cap while cranking engine. Check for strong arcing sparks. If no sparks, go to step d. If strong sparks are visible, go to step i.

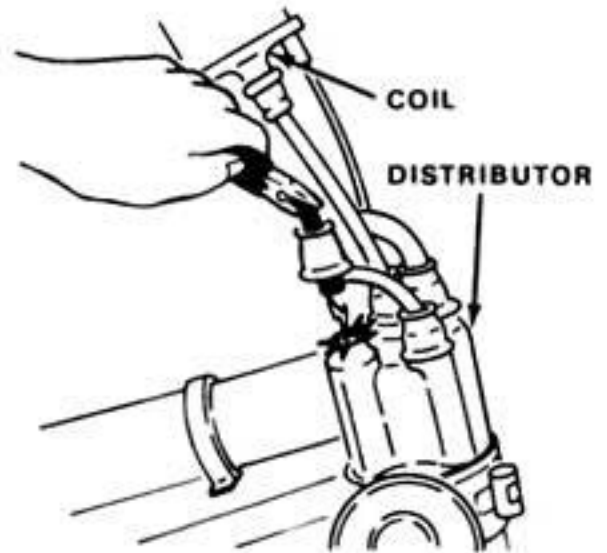

- d. Install spark plug cable on distributor cap. Pull cable from center terminal of distributor cap. Hold cable with insulated pliers by the insulation about  $\frac{1}{4}$  inch from a metal object such as engine case. Check for strong arcing sparks. If good, go to step e. If not good, go to step f.
- e. Inspect distributor cap and rotor. See Ignition Distributor, page 45. Install cable on center terminal of distributor cap.

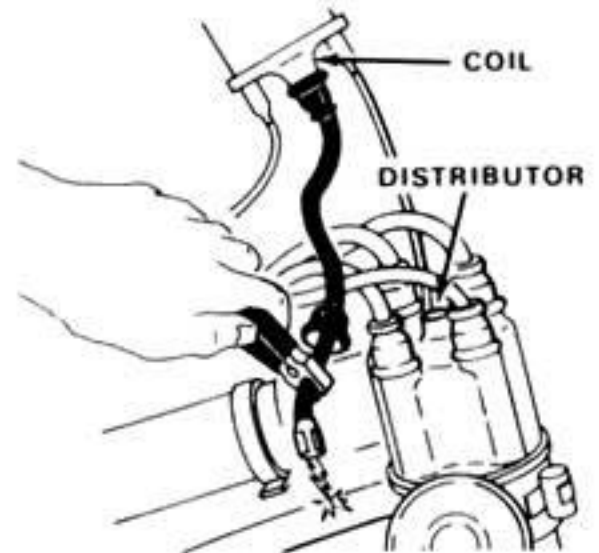

- f. Turn ignition switch off. Disconnect black wire from coil terminal. Turn on ignition. Holding black wire by insulation, strike it against blower housing. Check for spark. If it sparks, go to step g. If no spark, have dealer check the ignition system.

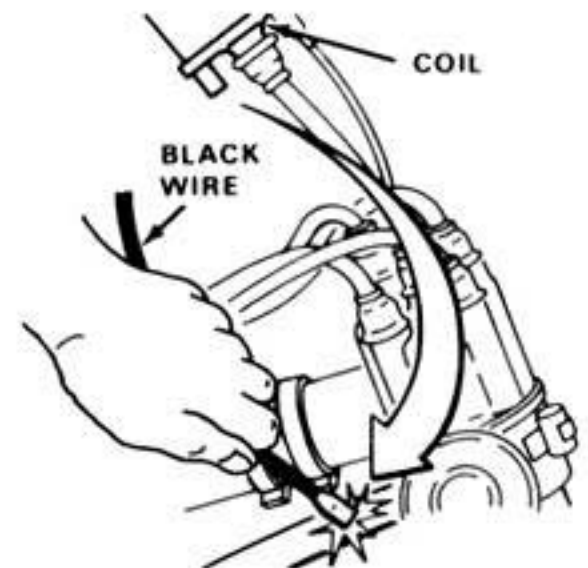

- g. With distributor cap off, have someone turn on ignition and turn engine over with starter. Check for spark between breaker points. If no spark, go to step h. If good, have coil replaced.
- h. If there was no spark, check contact breaker points for proper adjustment. See Adjusting Breaker Points, page 49. Install distributor cap. Check cable connections between coil and distributor cap. Tighten loose connections. Try to start car. If car will not start, have Dealer check ignition system.

- i. Install spark plug cable on distributor cap. Remove spark plugs. See Removing Spark Plugs, page 40. If plugs are dry, go to step k. If plugs are wet, go to step j.

**NOTE**

Spark plugs wet with gas indicate excessive fuel supply.

- j. Check condition of plugs. Replace as necessary. See Spark Plugs, page 39. Clean and dry spark plugs. Go to step l.

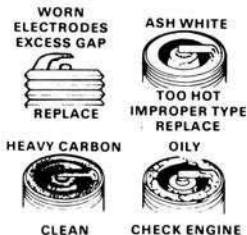

- k. If the plugs were dry, connect cables to plugs. Hold cable with dry piece of cloth to avoid shock. Hold plugs against some metal such as engine case. Have someone turn engine over with starter. Check for spark between electrodes of plugs. If no spark, go to step n. If spark, reinstall plugs. Go to step o.

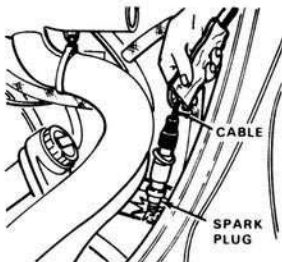

- l. Using starter, turn engine over with plugs removed for about 30 seconds. Reinstall plugs and start engine. If car will not start, go to step m.
- m. Tap around outside of carburetor with wooden or plastic tool handle. Wait a few minutes and try starting car. If car will not start, have Dealer check fuel system.
- n. Clean and dry ignition cables and spark plug connections. Reinstall spark plugs. See Spark Plugs, page 39. Try to start car. If car will not start, have Dealer check ignition system.

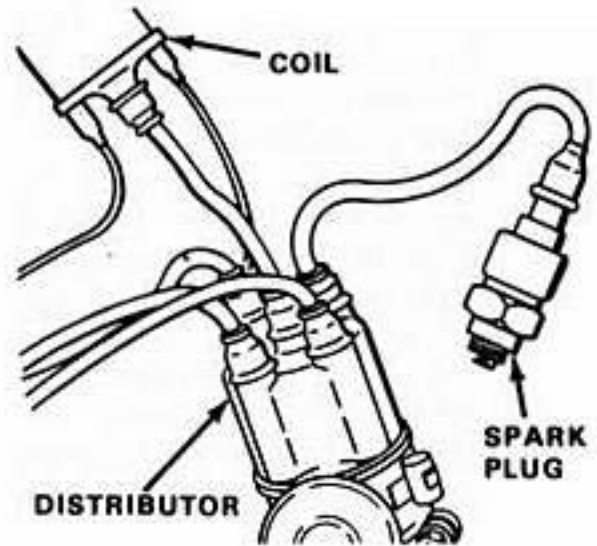

**WARNING**

Be extremely careful when disconnecting fuel lines. Be sure engine is cold. Do not smoke, keep open flame away.

**NOTE**

Be careful when removing fuel line clamp. After installing fuel line have clamp replaced as soon as possible.

- o. Pull the fuel line off carburetor. Hold line in a container. Have someone turn engine over with starter.
- p. If fuel comes out of line, have your Dealer check your carburetor. If fuel does not come out, clean the fuel pump filter. See Fuel Pump Filter, page 60.
- q. After cleaning filter, reinstall fuel line on carburetor and secure with clamp. Try to start car. If car will not start, have Dealer check fuel system.

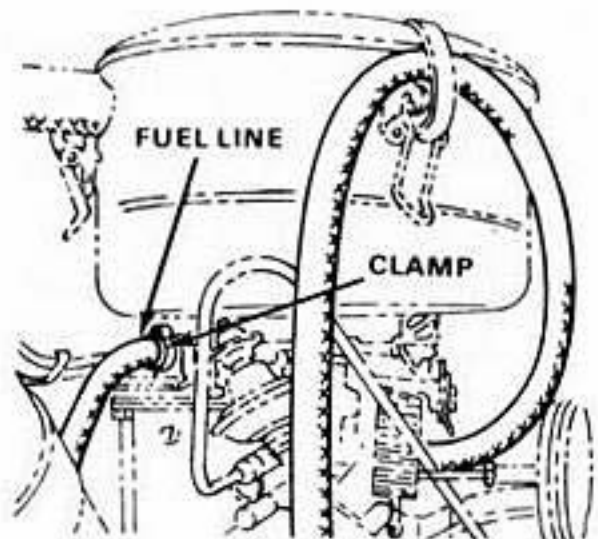



### 3. Engine Stalls Shortly After Starting

- a. Check the gas gauge. Add gas as needed.

#### WARNING

Be extremely careful of fire. If you see or smell fuel, ventilate and dry area. Remove fuel soaked rags to safe area.

- b. Check fuel pump filter for clogging. If dirty, clean filter. See Fuel Filter, page 60, and go to step c. If clean, go to step d.
- c. Try to run car. If car will not continue running, have your VW dealer clean all parts of the fuel system.
- d. With ignition off, depress the gas pedal once and let it up. Turn ignition on without attempting to start the car and let the car stand five minutes. (This should open the choke valve.)
- e. Depress the gas pedal again and let it up. Then raise the engine compartment hood and check position of the choke valve. It should be open as indicated by the position of the fast idle cam.
- f. If fast idle cam is not in the position indicated, choke valve is binding in closed position. Wire the cam in the proper position and drive the car to your dealer.

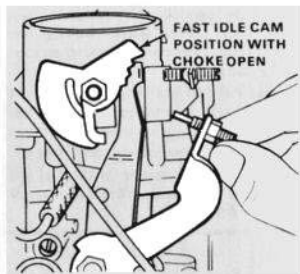
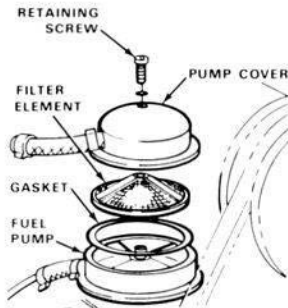

### 4. Engine Stalls While Vehicle is Driven

- a. Check the gas gauge. Add gas as needed.
- b. Check for loose connections at the coil, distributor, and spark plugs. Tighten as necessary.

- c. Pull any spark plug cable from distributor cap terminal. Hold the cable with pliers by the insulation, about  $\frac{1}{4}$  inch from terminal on cap while cranking engine. Check for strong arcing sparks. If no spark or weak spark, troubleshoot ignition system as directed in paragraph 2 above. If spark is O.K., go to step d.

**WARNING**

Be extremely careful when disconnecting fuel lines. Be sure engine is cold. Do not smoke. Keep open flame away.

**NOTE**

Be careful when removing fuel line clamp. After installing fuel line, have clamp replaced as soon as possible.

- d. Pull fuel line off carburetor. Hold line in a container and have someone turn engine over with starter. If fuel is not present, go to step e. If fuel is present, install fuel line on carburetor. Have dealer check carburetor.

**WARNING**

Remove fuel container to a safe area.

- e. Clean fuel pump filter. See Fuel Pump Filter, page 60. Go to step f.  
f. Install fuel line on carburetor and try to start car. If car will not start, have dealer check fuel system.

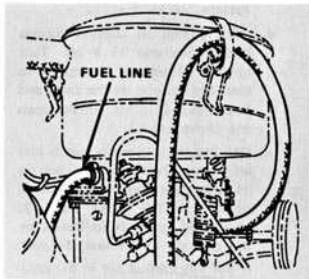
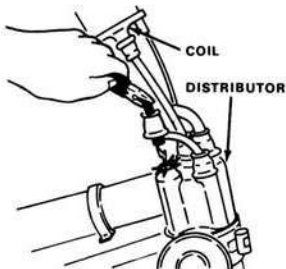

## 5. Oil Pressure Warning Light Comes on While Driving

- Stop car at once. Check oil level. If oil level is good, go to step b. If level is low, add oil as necessary. See Checking Engine Oil Level, page 25. Go to step c.
- If oil level is adequate and light still comes on, have VW dealer check engine as soon as possible.
- Have your dealer check engine to determine cause of low oil level.

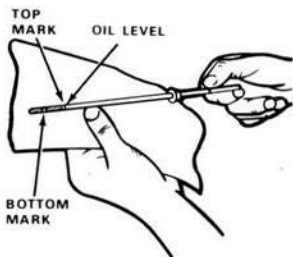

## 6. Generator and Cooling Warning Light Comes on While Driving

- Stop car and shut engine off.
- Check V-belt.  
If broken, replace. See V-Belt Replacing, page 59.  
If slipping, tighten. See V-Belt Adjusting, page 58.
- If V-belt is not broken or slipping, generator is probably defective. Drive immediately to a Dealer for repairs.

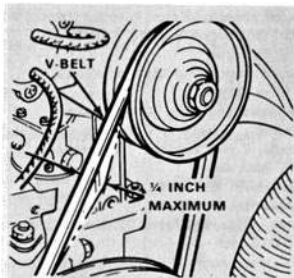

## 7. Automatic Stick Shift Lever Cannot Be Shifted

- Stop car and shut engine off.
- Check control valve fuse in engine compartment.  
If fuse is blown, replace. See Replacing Fuse, page 100.  
If fuse is not blown, go to step c.
- Check wiring to control valve. Tighten if necessary.

### NOTE

Control valve is located on left side of engine compartment.

If wiring is not loose, car requires more thorough checkout. Take it to your dealer for service.

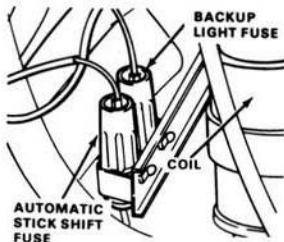

## Chapter 3 Tune Up

### *Tools Needed*

Box wrench, 13 mm,  $\frac{3}{8}$  inch drive  
Socket wrench, 10 mm,  $\frac{3}{8}$  inch drive  
Socket wrench, 13 mm,  $\frac{3}{8}$  inch drive  
Spark plug socket wrench,  $\frac{1}{16}$  inch,  
 $\frac{3}{8}$  inch drive  
Torque wrench, 0 to 150 foot pounds,  
 $\frac{3}{8}$  inch drive  
Extension, 2  $\frac{1}{2}$  inch,  $\frac{3}{8}$  inch drive  
Extension, 6 inch,  $\frac{3}{8}$  inch drive  
Handle, 8 inch (ratchet, T-bar, etc.),  
 $\frac{3}{8}$  inch drive  
Screwdriver, flat blade,  $\frac{7}{16}$  inch  
Screwdriver, flat blade,  $\frac{5}{16}$  inch  
Feeler gauge, flat type 0.004,  
0.016 inch  
Thickness gauge with bending lever,  
wire type for spark plugs, 0.020,  
0.024, 0.028 inch  
Dwell meter  
Tachometer  
Stroboscopic timing light  
Watch with sweep second hand  
Pocket knife  
Cardboard (calling card size and weight)  
Clean rags

### *Materials Needed*

2 valve cover gaskets, VW Part No.  
113 101 481E  
4 spark plugs, Bosch W145T1 or  
equivalent  
Set of distributor contact breaker points,  
VW Part No. 311 998 063  
Condenser, VW Part No. 113 905 295C  
Lithium grease  
Cleaning solvent  
Chalk or white paint

To get maximum gasoline mileage and best performance from your Volkswagen, the engine should be tuned at least every 6,000 miles.

With proper equipment this job can be done with little difficulty. Without the right tools, however, the job will be irritating and the results uncertain. If you do not have the tools, take the car to your Authorized Volkswagen Dealer. He is equipped to do the work consistent with existing emission control regulations.

Do not attempt to shorten a tune-up by completing only part of the job. This will most likely affect the emission control adjustments and result in unsatisfactory engine performance. Instead, work through the entire procedure step by step.

## 1. Tune Up

- a. Set parking brake. Place the transmission in neutral.
- b. Open engine hood.
- c. Perform tasks indicated on following chart:

<b><i>Necessary Tune Up Tasks Explained Elsewhere in the Manual</i></b>	<b><i>Chapter 5 References</i></b>	
	<b><i>Title (page)</i></b>	<b><i>Applicable Steps</i></b>
1. Valve clearance adjustment.	Adjusting valve clearance (42)	1.b. through 1.r.
2. Spark plug replacement	Spark plugs (40)	1.a., 1.b., 3.a., 3.b., & 4.a. through 4.e.
3. Distributor cap check	Removing and inspecting distributor cap (45)	1.a. through 1.e.
4. Distributor rotor check	Removing and inspecting distributor rotor (46)	2.a. through 2.c.
5. Contact breaker point replacement	Replacing contact breaker points (48)	2.a. through 2.i.
	Adjusting contact breaker points (49)	3.b. through 3.e.
6. Condenser replacement	Condenser (50)	1.a. through 1.h. & 2.a. through 2.j.
7. Dwell angle adjustment	Dwell angle check and adjustment (52)	a. through f.
8. Ignition timing adjustment	Ignition timing procedure (53)	a. through k.
9. Carburetor adjustment	Carburetor idle speed adjustment (55)	All
10. Throttle valve positioner adjustment	Throttle valve positioner (56)	1.a. through 1.e. & 2.a. through 2.f.

# Chapter 4

## Jacking and Supporting

### ***Tools Needed***

- Jack (provided with car)
- Long breaker bar (used to raise and lower jack)
- 2 Support stands 11 inches high when lowered
- 4 Wood blocks

### ***Materials Needed***

None

Your jack will be one of two types. It will raise or lower by moving a lever (long breaker bar) or by turning a handle. Never use any other type of jack on your car.

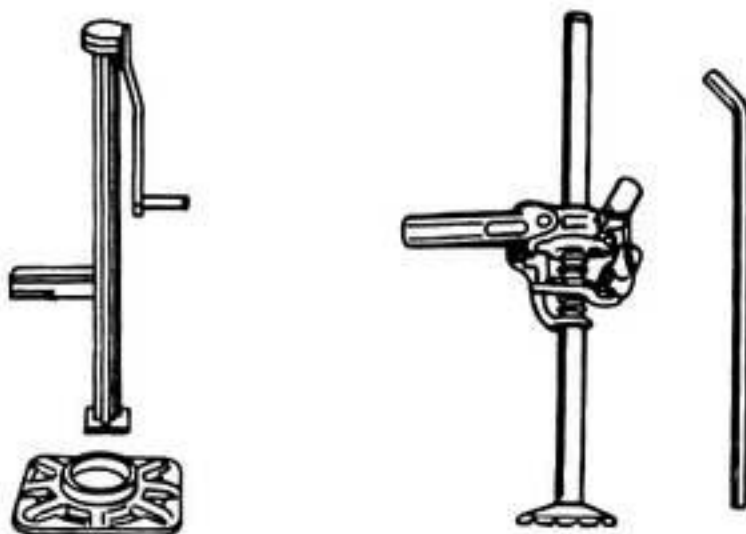

### **CAUTION**

Because of Volkswagen's unibody construction, scissors and bumper jacks are unsuitable for it.

When jacking, be critical of the surface the jack will rest on. For routine work, drive the car to a suitably firm, flat surface. If the car cannot be moved, improve the jacking surface by clearing and leveling. When using the crank jack, always use the base plate on soft surfaces. If necessary, put down a 2 x 8 x 8 inch wooden block to provide a firm flat base. A larger block can be used to spread the load bearing area on soft earth. Do not use concrete blocks, tile, rocks, etc.; they may crumble under the weight.

Before raising the car make sure it can not roll. Set parking brake. Place blocks in front of and behind both wheels on the side not being jacked. Remove the ground terminal from the battery to assure the car can not be started and driven off the support stands.

Except for changing a wheel under road conditions, never use the jack to support the car. Do not work under the car until it is on support stands. Use only sturdy commercial supports. Here again, avoid concrete blocks, stacked wood, and similar substitutes which may crumble or slip.

Remember, limit your work to that which can be done by supporting no more than two wheels at any time. Most tasks do not require more. For those that do, take your car to your local Authorized Volkswagen Dealer or to a service station where it can be placed on a lift.

Although the Volkswagen weighs about  $\frac{1}{2}$  less than larger cars, it requires the same care in jacking as any other car. Your Volkswagen has sockets in front of each rear fender. These sockets are designed and located to lift both the front and rear wheels on each side. The jack furnished with your car is made to fit into these sockets.

#### **WARNING**

Jacking at any other place could damage the car and may result in injuries.

The car should always be supported with stands and with at least two wheels on the ground.

#### ● **Right Side with Both Wheels Off the Ground**

This requires support stands under the front and rear of the right side. With the car jacked up, you can get at both wheels, heater control cable, valve cover, shock absorber, steering damper (Beetle) and the lines for the Automatic Stick Shift transmission. This method is needed to lubricate the front axle on the Beetle.

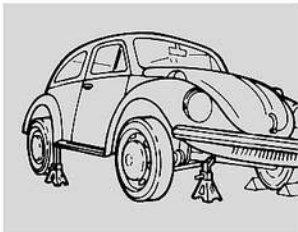

- **Left Side with Both Wheels Off the Ground**

This requires support stands under the front and rear of the left side. This gives you access to the clutch control cable, heater control cable, shock absorber, steering damper (Super Beetle), and valve cover.

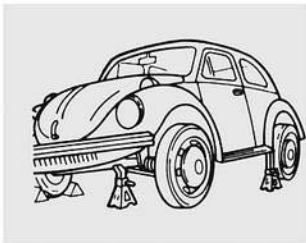

- **Jacking Either Side with Support Stand under Front and Rear**

- a. Drive car to a firm, level surface.
- b. Set parking brake.
- c. Place blocks in front of and behind both wheels opposite the side to be jacked.
- d. Lift rear seat and remove jack. Insert it in jacking socket.

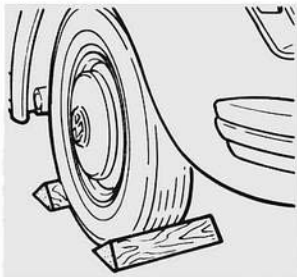

**WARNING**

If it is necessary to remove a wheel, break wheel bolts loose before raising car. Do not remove the bolts. See Removing a Wheel, page 105.

- e. Jack car about  $\frac{1}{2}$  inch higher than desired height.

**CAUTION**

Always leave  $1\frac{1}{2}$  inches between top of support stand and car. This is to assure that the jack can raise the car off the support stands to remove them.

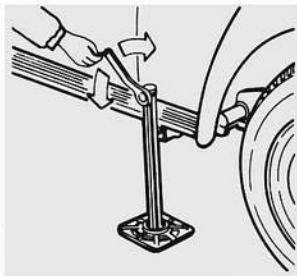



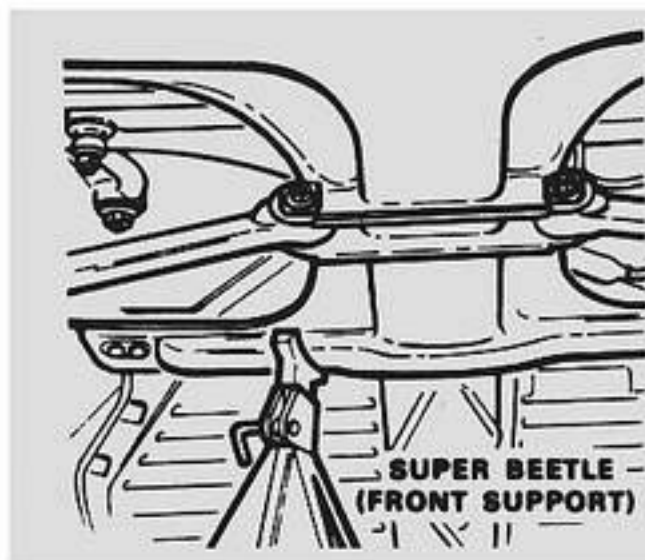
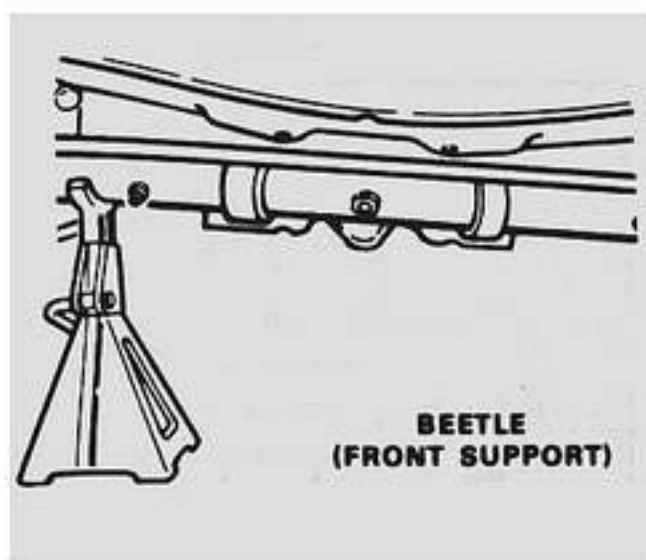

- f. Adjust two support stands to the desired height. Place them under the front and rear support points.
- g. Lower jack until car rests on support stands.
- h. Check placement of support stands. They should be vertically positioned under the car.
- i. When work is completed, replace wheel. See *Installing a Wheel*, page 106. Raise car with jack until it lifts off support stands.
- j. Remove support stands.
- k. Lower car to ground.
- l. Put jack away and install rear seat.
- m. Remove blocks from wheels.

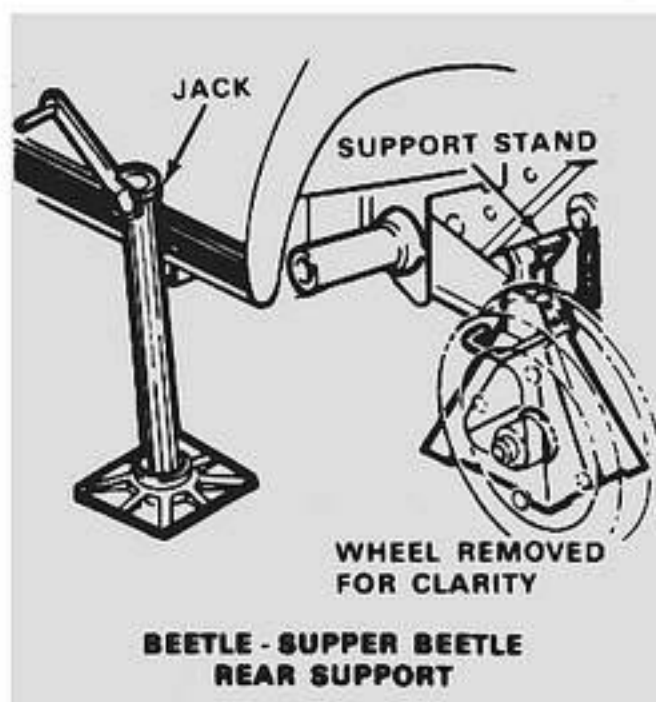

# Chapter 5

## What Should Be Done Regularly

A certain amount of adjustment and maintenance work should be carried out on your Volkswagen regularly to maintain its performance.

Your Authorized Volkswagen Dealer follows the schedule that is listed in your Owner's Manual. Much of this work can be performed by you. (We've described these tasks in this chapter.) But some of it requires the technical facilities only your dealer can supply. For this reason you are urged to remember that the job of scheduled maintenance is not completed by merely following this chapter; we recommend that you see your dealer at the appropriate intervals.

### Maintenance

Regular maintenance is necessary to get the best operation from your VW. The maintenance listed in the following chart are a part of the overall maintenance that your VW requires and which we feel you can do. Check with your dealer to find out what additional maintenance is required. The maintenance operations listed in the following chart should be performed at the intervals shown.

## Maintenance Requirements

<i>Operation</i>	<i>Every 3000 Miles</i>	<i>Every 6000 Miles</i>	<i>Every 12,000 Miles</i>
Lubrication (See lubrication requirements)			
Check condition of battery	X		
Replace spark plugs			X
Check and adjust valve clearance		X	
Check ignition distributor			X
Check, adjust, or replace contact breaker point			X
Check and adjust dwell angle			X
Check and adjust ignition timing			X
Check and adjust carburetor idle speed			X
Check, adjust, or replace V-belt		X	
Replace fuel pump filter		X	
Check clutch pedal free play		X	
Check exhaust system		X	
Check steering damper		X	
Check shock absorbers		X	
Check brake fluid		X	
Check windshield washer fluid	X		

### NOTE

This list is only partially complete. It includes those tasks easily performed by you. Additional maintenance tasks (see the full listing in your Owner's Manual) should be performed by your Authorized Volkswagen Dealer.

## Lubrication

Regular lubrication will prevent parts from abnormal wear. The following chart gives the proper lubricants and the normal intervals between servicing. These recommended intervals are for normal driving conditions on paved highways. Your own driving requirements may make more frequent servicing advisable. In any case, remember that failure to lubricate your car can damage it while extra care will only increase protection.

## Lubrication Requirements

<i>Operation</i>	<i>Every 3000 Miles</i>	<i>Every 6000 Miles</i>	<i>Lubricant</i>	<i>Types</i>
Change engine oil.	X		Engine oil	SAE 40*** in hot climate (above 80°F) SAE 30*** in warm seasons and in areas with a temperate climate (40° to 80°F) SAE 20 W/20*** in winter (5° to 40°F) SAE 10 W*** when average temperature is below 5°F. SAE 5 W*** in areas with temperatures below -13°F.
Check transmission fluid level.		X	Hypoid oil	Hypoid oil SAE 90 or equivalent to MIL-L-2105 B specifications in areas with moderate climate. Use SAE 80 in areas with temperatures below -13°F.
VW automatic stick shift. (Torque converter circuit) Check level.		X	ATF	DEXRON® Automatic Transmission Fluid.
Clean and service air filter.		X	Engine oil	SAE 30 all year. SAE 10 in arctic climate.
Lubricate front axle (Beetle).		X**	Lithium grease	Multi-purpose grease.
Lubricate door lock cylinders.	X		Graphite powder	Local supply.
Lubricate door and striker plates.	X		Dry stick lubricant	Local supply.
Lubricate hood locks and hinges	X*		Engine oil	SAE 30***

\* Or every 3 months.

\*\* At least once a year if you drive your car less than 6,000 miles a year.

\*\*\* Labeled "for service MS" or new designation SD.

## Engine Oil Change

### **Tools Needed**

Box wrench, 21 mm  
Offset box wrench, 10 mm  
Oil can opener/spout  
Oil drain pan (screen cover)  
Clean rag  
Torque wrench, 0 to 150 foot pounds,  
     $\frac{3}{8}$  inch drive  
Socket wrenches, 10 mm and 21 mm,  
     $\frac{3}{8}$  inch drive

### **Materials Needed**

3 Quarts of engine oil (labeled "for service MS" or new designation SD)  
2 Oil strainer gaskets — VW Part No. 113 115 189 A\*  
6 Copper washers, oil strainer cover — VW Part No. N 13 8 04 2\*  
1 Sealing washer/oil drain plug — VW Part No. N 13 815 2\*  
Suitable cleaning solvent

---

\* Also available as a kit — VW Part No. 113 198 031

Regardless of how you drive your car, the oil in the engine collects fuel, water, acids or particles removed by wear. These particles in turn cause the oil to lose some of its lubricating ability, even if you use the very best brand of oil. Dirty engine oil will result in increased wear and a shorter service life. The normal interval for changing oil is 3,000 miles. Exceptions to this recommendation are as follows:

- If you drive mostly short distances and in city traffic, change your oil more frequently (about 1,500 miles) particularly in cold weather.
- If you drive only a few hundred miles a month, mostly short distances and in city traffic, it is advisable to change the oil every 6 to 8 weeks.
- If temperatures are consistently below  $-13^{\circ}\text{F}$ , the oil should be changed every 750 miles.

### **When changing the oil, always remember:**

- 1 - Before draining your engine oil, check for a way to dispose of the old oil. Do not discard old oil in sewage drains, on garden soil or in open streams. Your zoning regulations or environmental rules will tell you how you can dispose of it. Should the discarding of the old oil present a problem to you, we suggest that you have your oil changed at your dealer or at a service station.
- 2 - Engine oil has to be warm in order to remove all foreign particles when draining the engine.
- 3 - Select a suitable container in which to drain the oil. Be sure that it is large enough to accept all of the oil. A screen placed over the receptacle will help you catch anything that could accidentally fall into the oil.
- 4 - Never use cheap or improper lubricants. They can damage your engine and cost you more in the long run.
- 5 - When checking the oil shortly after an oil change, do not be alarmed if the oil coloring has changed. Even good quality oil will darken after a short period of running time.

## 1. Draining Engine Oil

- Run engine until oil is warm.
- Shut engine off.
- Place oil drain pan under engine.

### WARNING

When removing plug with fingers, keep your arm as high as possible. This will prevent hot oil from running down your arm. Wear eye protection such as safety glasses.

- Using the 21 mm box end wrench, loosen and remove plug.

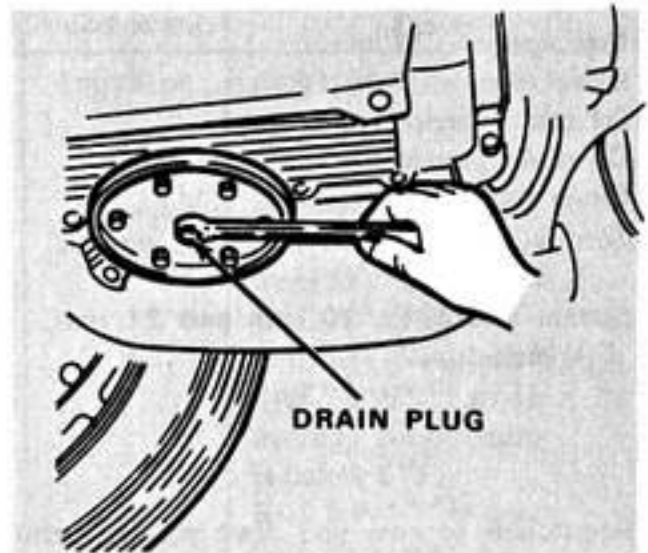

## 2. Removing Oil Strainer

- Using the 10 mm offset box wrench, remove six cap nuts holding oil strainer cover plate. Discard the six copper washers under the nuts.
- Remove cover plate and oil strainer.
- Remove and discard paper gaskets. Make sure all traces of gaskets are removed from strainer.
- Wash strainer in suitable solvent.

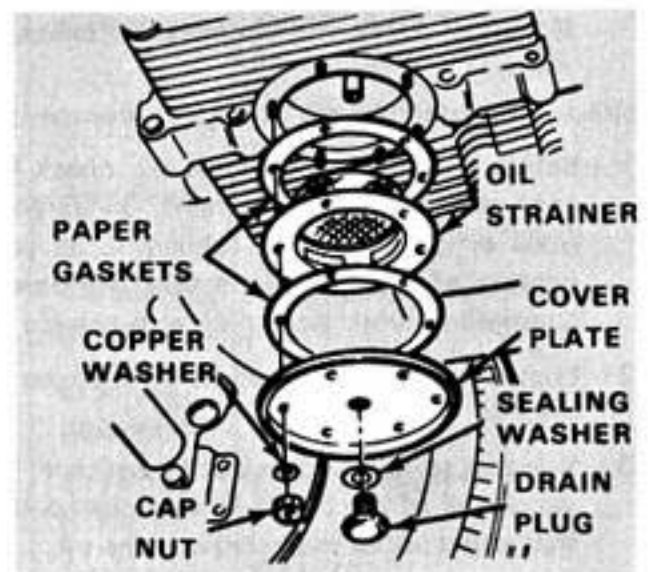

### 3. Installing Strainer

- a. Place a new oil strainer gasket on each side of strainer.
- b. Place strainer and gaskets on cover plate. Push strainer into housing. Rotate cover plate until holes are in line with mounting bolts. Push the cover up to seat it.

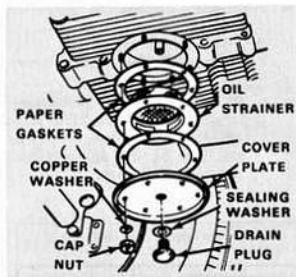

- c. Reinstall cap nuts. Use a new copper washer under each. Tighten all nuts finger-tight.
- d. Using the torque wrench and the 10 mm socket wrench, tighten each cap nut to 5 foot pounds in the sequence shown.
- e. Use a new sealing washer under drain plug. Thread the drain plug into the cover. Using a torque wrench and the 21 mm socket wrench, tighten the plug to 25 foot pounds.

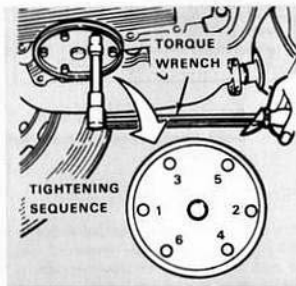

#### 4. Replacing Engine Oil

- a. Raise engine hood.
- b. Unscrew oil filler cap and remove it.
- c. Pour in 5.3 U.S. pints (4.4 Imperial pints) of oil labeled "for service MS", or new designation SD. Use the oil can opener/spout. Select oil as follows:

Hot months (above 80°F)	SAE 40
Warm months temperate climate (40° to 80°F)	SAE 30
Winter or cold climate (5° to 40°F)	SAE 20 W/20
Cold climate with average below 5°F	SAE 10 W
Arctic climate with temperatures below -13°F	SAE 5

- d. Pull dipstick out and wipe it off.
- e. Insert dipstick, pushing it all the way down.

- f. Pull dipstick out again and check oil level. It should be on or near the top mark.
- g. Insert dipstick. Install oil filler cap and tighten.
- h. Close engine hood.

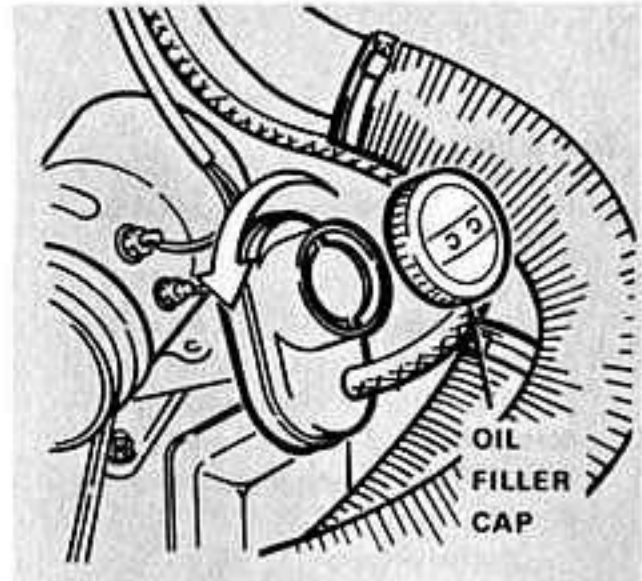

#### CAUTION

Do not drive at high speeds for long periods if using SAE 10 W and the outside temperature is above 32°F, or if using SAE 5 W oil and the temperature is above 5°F.

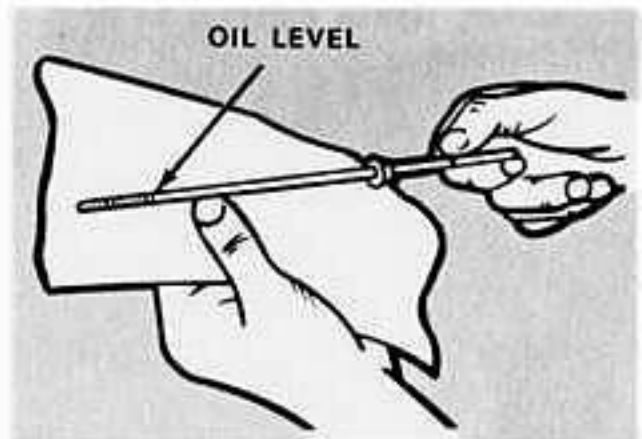
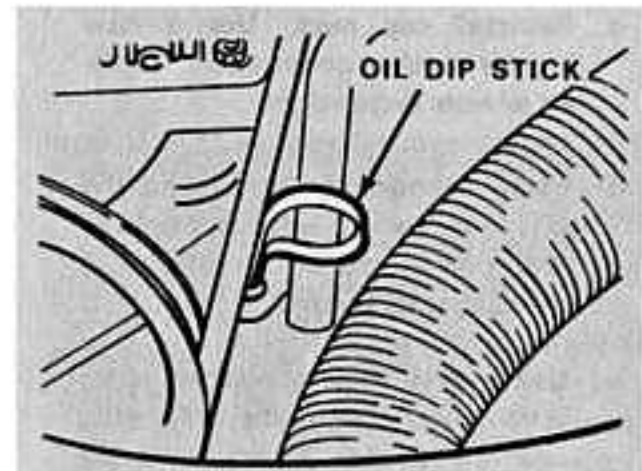



## Checking Engine Oil Level

- a. Pull dipstick out. Using a rag, wipe the dipstick.
- b. Insert dipstick, pushing it all the way down.
- c. Pull dipstick out again and check the oil level. If the level is below the bottom mark, add oil.
- d. Unscrew oil filler cap and remove it. Add oil to bring the level up near the top mark.
- e. Install oil filler cap and tighten.
- f. Repeat steps a., b., and c. to determine that oil level is satisfactory.

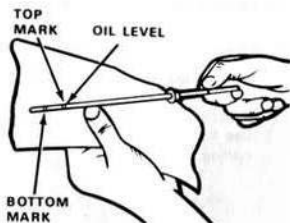
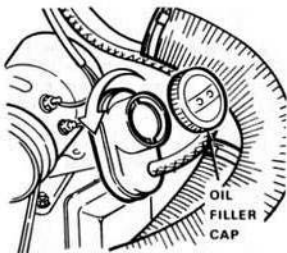

## Transmission

### Tools Needed

Hex head wrench, 17 mm  
Support stand

### Materials Needed

None

The transmission oil is changed by your dealer at 600 miles. Under normal driving condition you should not have to change the fluid again. However, you should check the fluid level every 6,000 miles. To replace the fluid or even replenishing it should be done by your VW dealer. It requires a special filling apparatus. Also, the fluid is generally not marketed in small enough quantities to fit your need.

### 1. Gaining Access To Transmission

#### WARNING

Follow the jacking procedures in Chapter 4, Jacking and Supporting, page 14. Do not work under the car until the car is supported by support stand.

- a. Using a ruler, measure the distance from the left rear torsion bar to the ground. Adjust a support stand to match the measurement.
- b. Remove the left rear wheel. See Removing a Wheel, page 105.

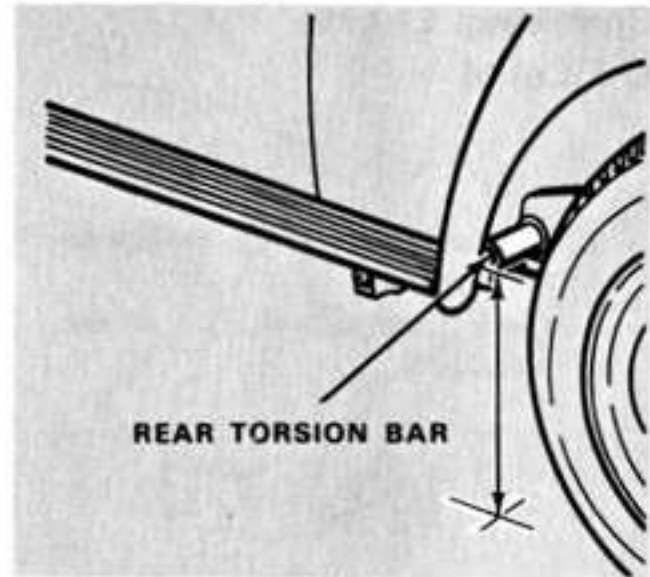

- c. Position the support stand under the torsion bar. Lower the car until the bar rests on the stand. See Chapter 4, Jacking and Supporting, page 14.

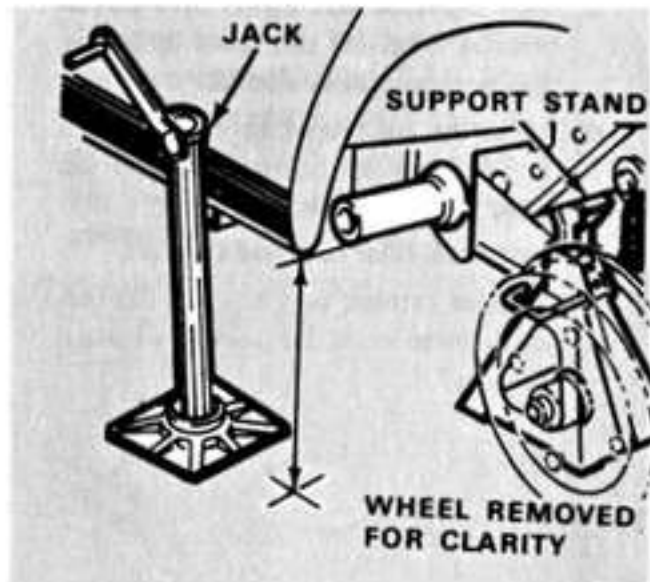

## 2. Checking Fluid Level

- a. Using the 17 mm hex head wrench, remove the oil filler plug on the left side of the transmission case.

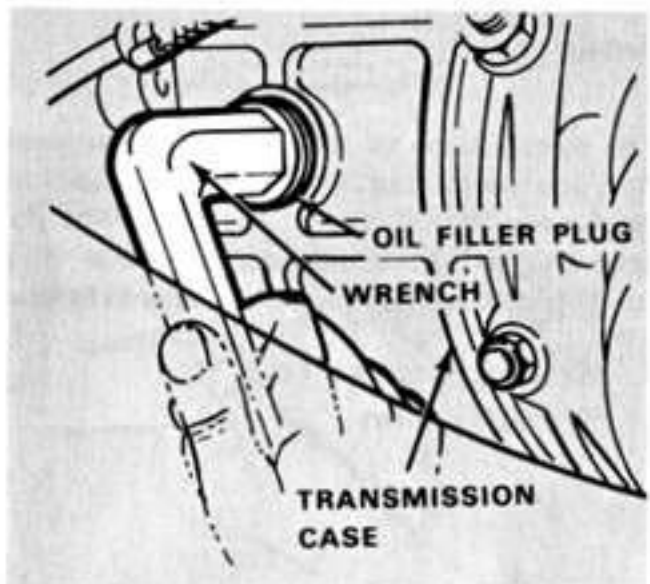

- b. Using your finger, check fluid level. It should be up to the lower edge of the opening. If not, transmission fluid must be added by your dealer or a service station attendant.

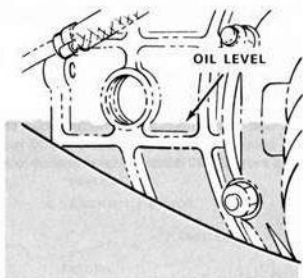

- c. Screw oil filler plug into transmission. Using 17 mm hex head wrench, tighten plug.

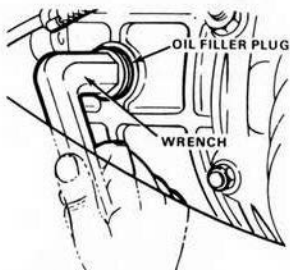

### Lowering the Car

- a. Jack up car and install wheel and hub cap. See *Installing a Wheel*, page 106.
- b. Remove the support stand.
- c. Lower the car to the ground. See *Chapter 4, Jacking and Supporting*, page 14.

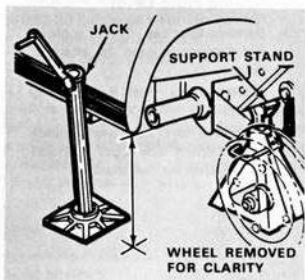

## Transmission — Automatic Stick Shift

### Tools Needed

Oil can opener/spout  
Clean rag

### Materials Needed

DEXRON<sup>®</sup> automatic transmission fluid

The automatic transmission fluid (torque converter circuit) does not require changing, but you should check the level every 6,000 miles. Check fluid level of transmission and final drive every 6,000 miles. Refer to Transmission, page 25.

### 1. Gaining Access

- Shut engine off.
- Raise engine hood. Locate the automatic transmission fluid tank. It is on the right side of the engine compartment.

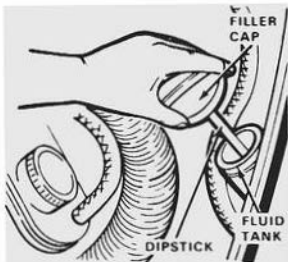

### 2. Checking Fluid Level

- Remove filler cap. Using a clean lint free cloth, wipe the attached dipstick.
- Insert the cap. Push it all the way down.
- Withdraw the cap and dipstick again. Check fluid level. It should be between the two marks.

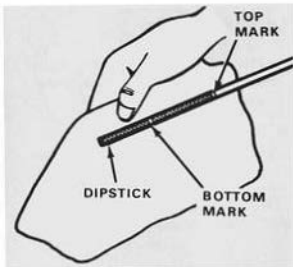

### 3. Servicing

#### CAUTION

Do not fill the transmission above the top mark.

- a. If level is on or below bottom mark, add fluid to bring level near the top mark.
- b. Insert filler cap.
- c. Check the lines from the transmission to the fluid reservoir for
- d. If lines are leaking at fittings, tighten fittings. Have any damaged tubing replaced. Leakage from the transmission case requires maintenance by your VW dealer.
- e. Close engine hood.

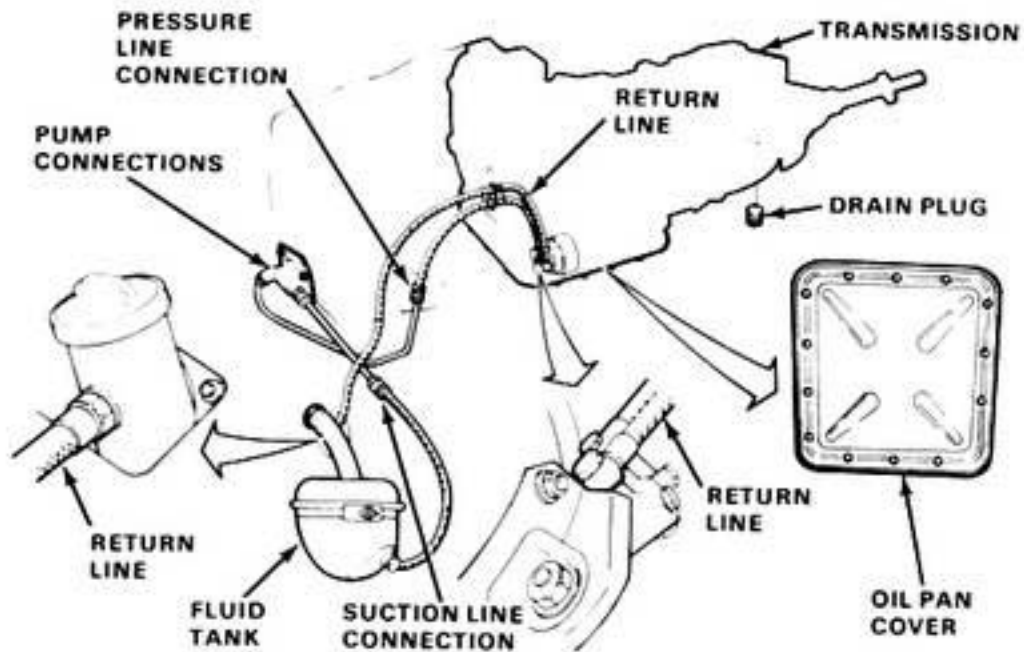

### Air Cleaner

#### Tools Needed

Screwdriver, No. 2 Phillips  
Screwdriver,  $\frac{7}{16}$  inch flat blade type  
Wooden or plastic scraper  
Clean rag

#### Materials Needed

SAE 30 Engine oil ("For service MS",  
or new designation SD)  
Suitable cleaning solvent

Dust in the air that is drawn in by the carburetor is trapped by a filter element in the upper section of the air cleaner. The dust is washed out of the filter by motion of oil in the lower section as the car moves. In time, this dust collects as a layer of sludge at the bottom of the air cleaner. This sludge must be removed periodically. The air cleaner should normally be serviced every 6,000 miles. However, if you do a lot of driving on very dusty roads, check the air cleaner more frequently.

#### NOTE

When there is about  $\frac{1}{4}$  inch of oil above the sludge, you must clean the lower section and change the oil in the air cleaner.

## 1. Removing Air Cleaner

- Lift engine hood.
- Pull the charcoal filter hose (A), and crankcase ventilation hose (B) from the air cleaner.
- Loosen the clamp on preheated intake air hose (C). Pull the hose from the air cleaner.
- Release clip (D) supporting the green vacuum hose. Move the hose aside. The hose need not be disconnected.
- Remove vacuum hose (G) from left top of air cleaner.
- Remove screw (E) in the air cleaner support bracket.
- Loosen air cleaner clamp screw (F). Lift the air cleaner from the carburetor. Keep it upright to avoid spilling oil.

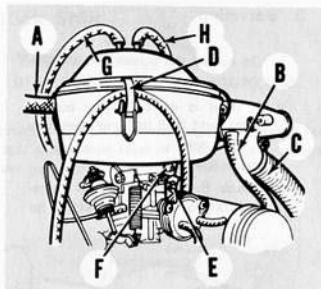

## 2. Cleaning and Servicing

- Disconnect temperature control hose (H) from top of air cleaner.
- Release remaining 3 clips around the air cleaner. Lift the top part off.

### WARNING

Be very careful when cleaning with solvents. Work in a well ventilated area. Do not use equipment that can ignite fumes. Do not smoke.

- Drain the oil from the bottom section. Clean carefully with solvent.
- Fill the bottom section with fresh oil until the level reaches the baffle below the intake horn. A little less than a pint is required.

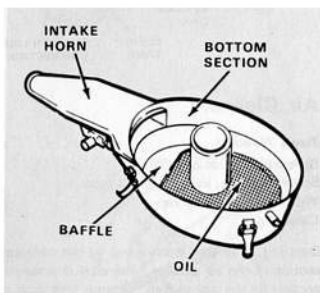

### NOTE

In most climates, use SAE 30 grade oil all year round. Use SAE 10 grade in arctic climates.

- e. The top section does not normally need cleaning. However, if holes at bottom of filter element are partly blocked with dirt, remove the dirt by scraping with a wooden or plastic tool.

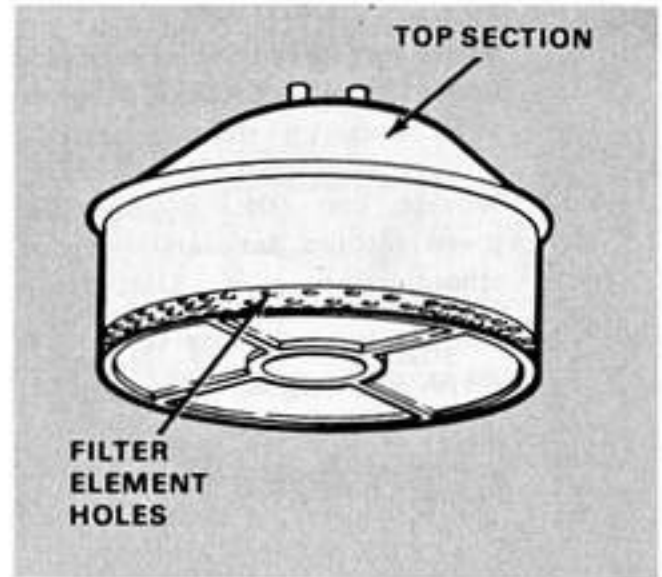

- f. Check control flap. It should move freely. If it is tight, apply oil to the hinge points and work it until it moves freely.

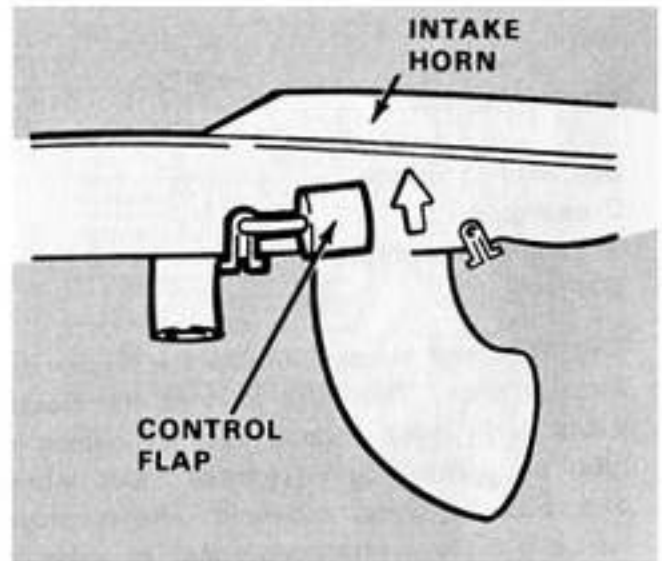

### 3. Installing Air Cleaner

- a. Place top section on bottom section and hook the clips.
- b. Connect temperature control hose (H) to the tube on the right top of the air cleaner.
- c. Set air cleaner on carburetor so intake horn points to right of car.
- d. Install screw (E) in the air cleaner support bracket.

#### CAUTION

Do not over-tighten screw (F) on installation.

- e. Tighten air cleaner clamp screw (F) until snug.

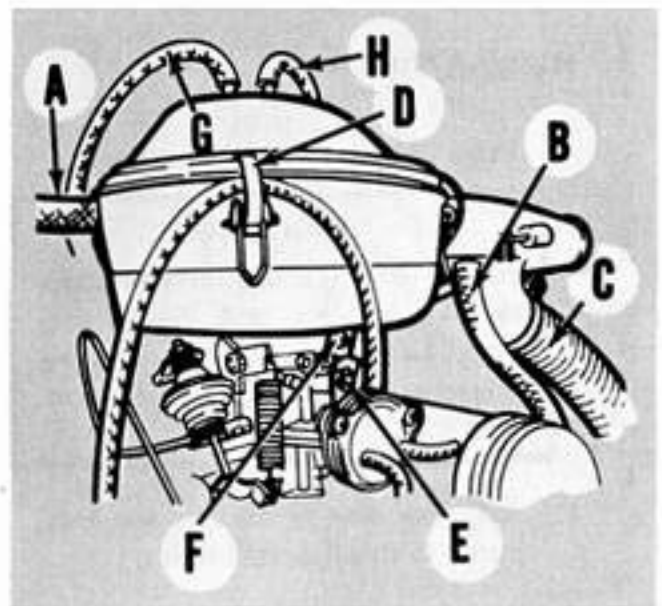

### CAUTION

Make sure green vacuum hose is under clip. If left free, it could restrict controls on the carburetor.

- f. Release clip (D). Position the green vacuum hose under it, and rehook clip.
- g. Connect vacuum hose (G) to the left top of the air cleaner.

### CAUTION

Be sure hoses (G) and (H) are not interchanged during installation.

- h. Install preheated intake air hose (C). Tighten restraining clamp.
- i. Install charcoal filter hose (A) and crankcase ventilation hose (B).
- j. Close engine hood.

## Front Axle

### Tools Needed

Box wrench, 7 mm  
Grease gun  
2 Support stands  
Old rags

### Materials Needed

Multi-purpose grease (Lithium based)

The front end suspension on the Super Beetle is permanently lubricated and requires no maintenance. The front axle of the Beetle, however, should be lubricated every 6,000 miles or at least once a year whichever occurs first. Be careful in selecting the proper lubricant. This special grease must lubricate dependably under pressure while driving and must be water repellent. We recommend a "multi-purpose grease" (Lithium based) which has these characteristics. In order for the lubricant to reach the bearings, you must first raise one side of the car so that one wheel hangs free. Repeat for other side.

### 1. Raising the Car

- a. Drive the car to a level surface.

#### WARNING

Follow jacking procedures in Chapter 4, Jacking and Supporting, page 14. Do not work under the raised car until the car is on support stands.

- b. Jack one side of the car and support it with support stands.

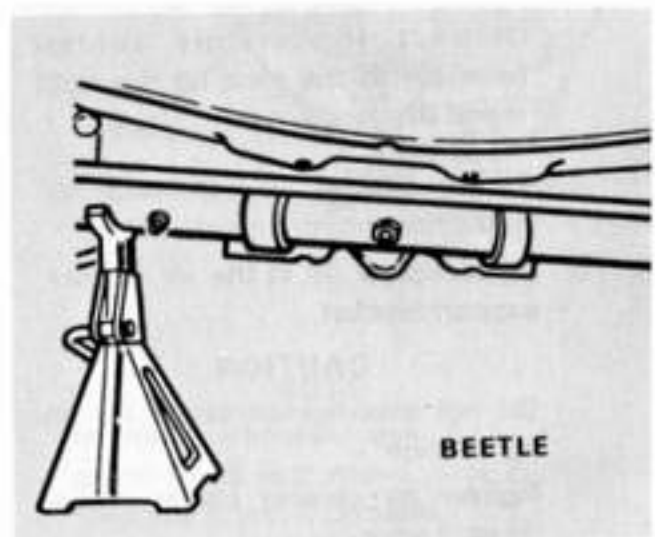



## 2. Servicing

- a. Wipe road dirt off appropriate grease fittings and check them. Replace any damaged fittings with new ones. Fittings are available at your VW dealer. Use a 7 mm box end wrench to remove damaged fittings.

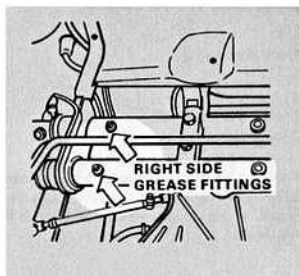

- b. Wipe grease gun nozzle clean. Inject lubricant in each of two axle tube fittings until grease begins to come out of torsion arm sealing rings.
- c. Wipe off excess grease, particularly from rubber parts such as tires, brake lines, hoses, etc.
- d. Lower car to ground as directed in step 3 below. Jack other side of car as directed in step 1 above. Service the other two axle tube fittings as directed in steps 2.a. thru c.

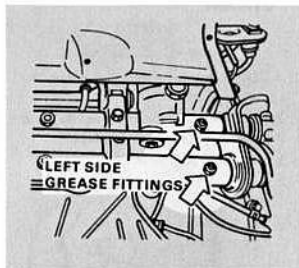

## 3. Lowering the Car

### WARNING

Follow the jacking procedures in Chapter 4, Jacking and Supporting, page 14. Do not work under the raised car.

- a. Jack the car off the stands. Remove the stands. Lower the car.
- b. Stow the jack.

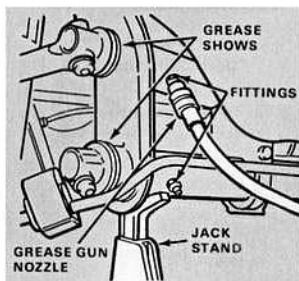

## Door and Hood Locks

### Tools Needed

Oil can  
Screwdriver, flat blade  
Clean rags

### Materials Needed

SAE 30 engine oil  
Powdered graphite

Door and hood locks should be lubricated every 3,000 miles. Driving in salt or dusty conditions may require that the locks be lubricated more often. To lubricate the door hinges, a special grease gun adapter is necessary. Have the hinges lubricated at your VW Dealer.

### 1. Lubricating Door Lock Cylinder

#### NOTE

Do this at both door locks.

- Dip key in powdered graphite. Insert key in lock.
- Turn key several times to coat cylinder parts with graphite.
- Remove and clean key.

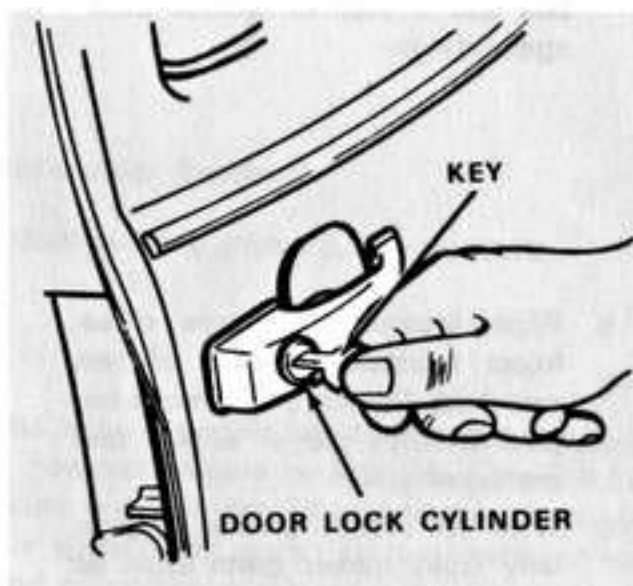

### 2. Lubricating Door Lock Mechanism

#### NOTE

Do this at both door locks.

- Open door.
- Using the screwdriver, pry out plastic plug from access hole.

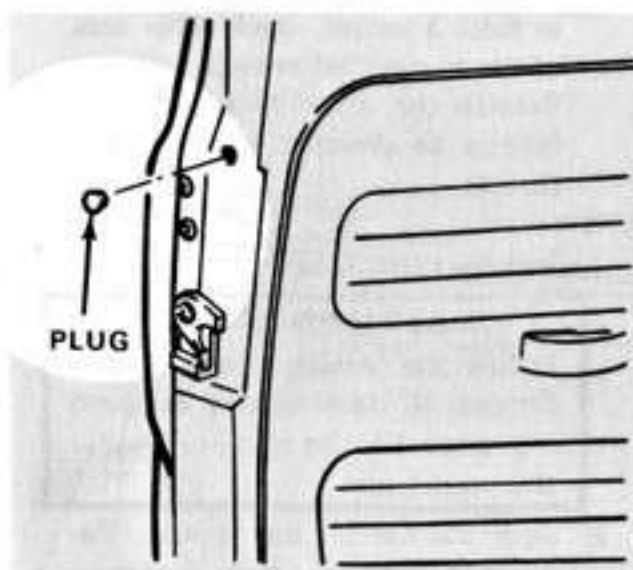

- c. Insert spout of oil can in access hole. Apply a few drops of oil to the lock mechanism.
- d. Withdraw spout. Wipe up any spilled oil. Install plastic plug.

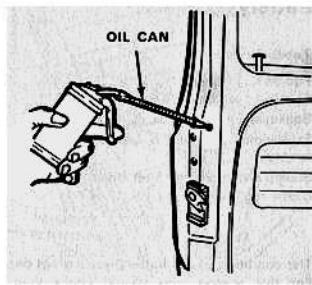

### 3. Lubricating Hood Locks and Hinges

#### NOTE

Do this at both front and rear hook locks and hinges.

- a. Raise hood.
- b. Lubricate all lock and hinge pivot points with oil.
- c. Close hood.

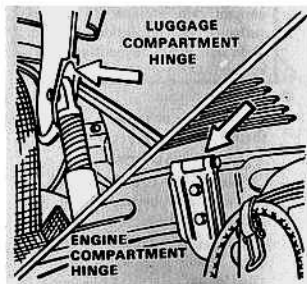
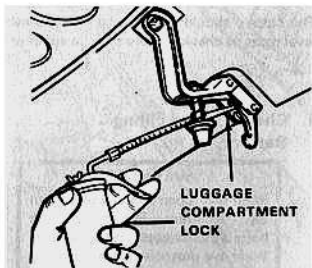

## Battery

### Tools Needed

Funnel  
Open end wrench, 13 mm  
Socket wrench, 19 mm,  $\frac{3}{8}$  inch drive  
Extensions, 2  $\frac{1}{2}$  and 6 inches,  $\frac{3}{8}$  inch drive  
Sliding T-handle,  $\frac{3}{8}$  inch drive  
Clean rag

### Materials Needed

Distilled water  
Silicon spray or petroleum jelly

The condition of the battery has a great deal to do with whether your VW will start reliably. For this reason, you should check your battery at regular intervals. The electrolyte level of the battery will drop as the battery is charged while driving. How often water must be added to the battery depends on driving conditions and the time of year.

The battery should normally be checked every 3,000 miles. As a general rule, the battery level must be checked more often in summer than in winter.

### 1. Checking and Filling Battery

#### WARNING

Keep any open flame away from top of battery. Fumes from the battery could cause it to explode. Wear eye protection such as safety glasses when working with battery. Do not allow battery fluid to contact skin, clothes, or painted surfaces. Use a solution of baking soda and water to neutralize any spilled fluid.

- Lift up back seat.
- Remove filler plugs by unscrewing them from battery.

#### CAUTION

Do not overfill battery. Fluid will overflow when battery is charging and cause damage.

- Check level of fluid (see illustration). If fluid level is low, add distilled water.

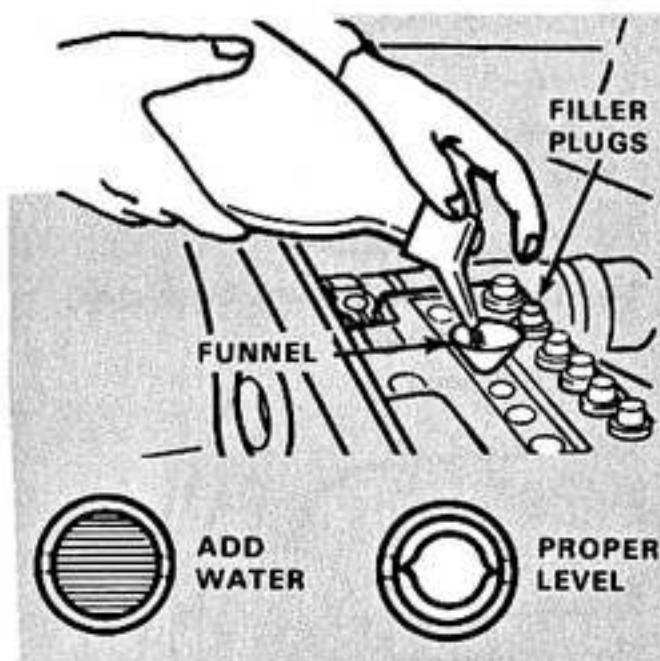

#### WARNING

Do not use food containers such as beverage bottles to store battery water. Use containers like detergent bottles etc. After filling battery, wash funnel. Keep funnel and battery water bottle out of reach of children.

- d. Check terminals and connections. They should be free of any dirt. Make sure connections are tight. Then cover terminals and connections with a film of silicone spray or petroleum jelly.
- e. Check ground connection to body. It should be clean and tight.

#### **WARNING**

Do not use a battery booster or jumper cables to start the car when the battery is run down. This could cause sparking which could cause the battery to explode. Also the charging circuit could be damaged. Remove a run-down battery and have it slow-charged at your VW Dealer or a service station.

## 2. Removing Battery

- a. Lift up back seat. Take seat out of car.
- b. Fold right rear floor mat out of way.
- c. Push out bottom of kickboard until it can be removed.

#### **CAUTION**

Make sure battery filler caps are in place and tight before removing battery.

- d. Using a 13 mm open end wrench, loosen bolt and nut holding ground strap on battery terminal. Spread open strap connector by inserting a screwdriver between connector halves and twisting the screwdriver. Lift connector from terminal.
- e. Lift plastic cover from positive terminal. Using the 13 mm open end wrench, loosen bolt and nut holding positive cable on terminal. Spread open cable connector and lift connector from terminal.

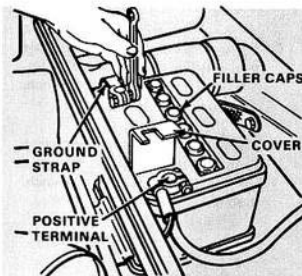
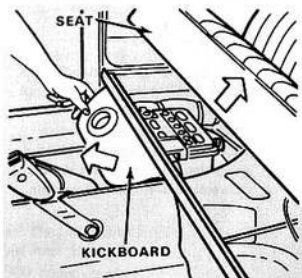
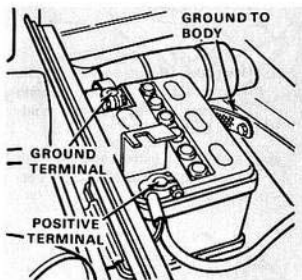

- f. Using the 19 mm socket wrench, remove nut and washer securing holddown plate. Remove hold-down plate.
- g. Carefully tilt battery toward front of car and slide it back. Lift battery out of car.

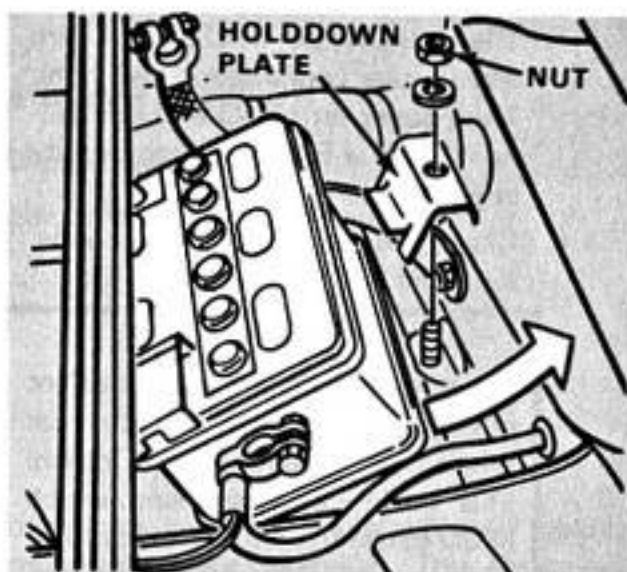

### 3. Installing Battery

- a. Place battery in position. Slide battery toward front of car until bottom of battery is properly seated and secure.
- b. Place holddown plate over stud. Using the 19 mm socket wrench, secure plate with nut and washer.

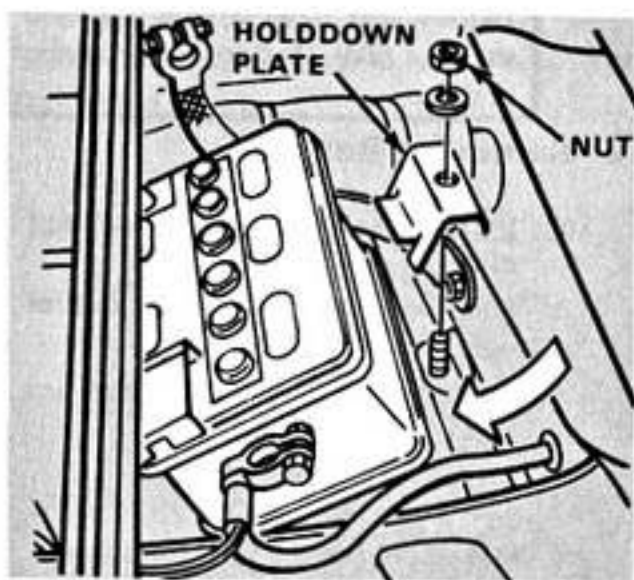

- c. Place connector of positive cable over positive battery terminal. Using the 13 mm open end wrench, tighten nut.
- d. Place connector of ground strap over negative battery terminal. Using a 13 mm open end wrench, tighten nut.

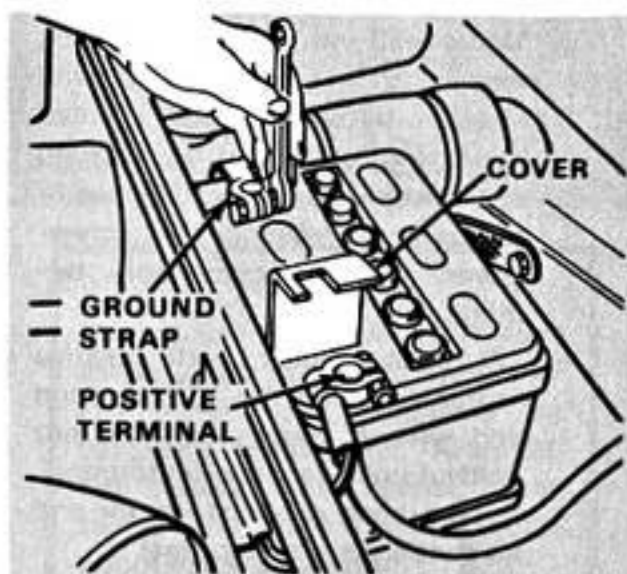

- e. Apply a film of silicone spray or petroleum jelly to both connectors and terminals. Close plastic cover over positive terminal.

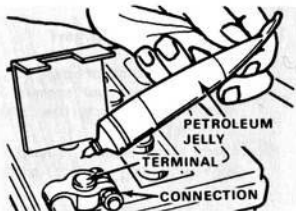

- f. Place top edge of kickboard under support. Slide bottom of kickboard back. Align heater outlet with opening in kickboard. Fold floor mat down.
- g. Check area to be sure all tools are removed.
- h. Place safety belt buckles in position to be placed on seat.
- i. Place seat in position in car. Slide back edge of seat into position. Lower front edge of seat down on support. Push seat back until it drops into position.

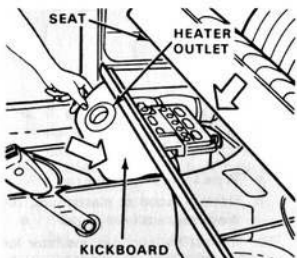

## Spark Plugs

The spark plugs ignite the fuel to run your car. They should be in good operating condition, be correctly adjusted, and have the specified heat value.

Spark plugs should be replaced every 12,000 miles. However, they should be checked every 6,000 miles to determine their condition. (See illustration under Cleaning and Inspection, page 40.)

### **Tools Needed**

- Spark plug socket wrench,  $1\frac{7}{16}$  inch, 12 point (with rubber insert inside socket wrench),  $\frac{3}{8}$  inch drive
- Sliding T-handle or ratchet, maximum 8 inches long,  $\frac{3}{8}$  inch drive
- Extension, 2  $\frac{1}{2}$  inches,  $\frac{3}{8}$  inch drive
- Wire type thickness gauge with bending lever for spark plugs, 0.020, 0.024, 0.028 inch
- Torque wrench, 0 to 150 foot-pounds,  $\frac{3}{8}$  inch drive
- Clean rag
- Wood or plastic pick

### **Materials Needed**

- 4 spark plugs (Bosch W145T1 or equivalent)

## 1. Removing Spark Plugs

- Pull connector off of spark plug. Mark connector and engine to identify where it goes. Use chalk or grease pencil.
- Using socket wrench, T-handle, and extension, remove spark plug.

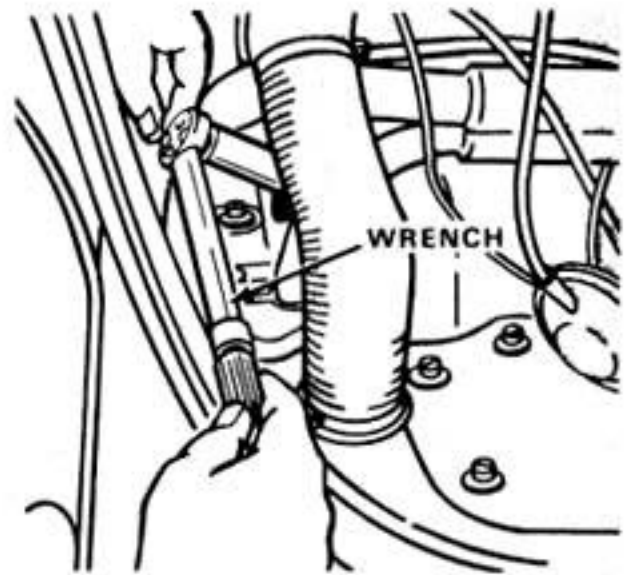

## 2. Cleaning and Inspection

- Wipe spark plug with a rag.
- Using a wood or plastic pick, remove deposits from plugs.
- Inspect the porcelain insulator for signs of damage. Check condition of plug as shown.

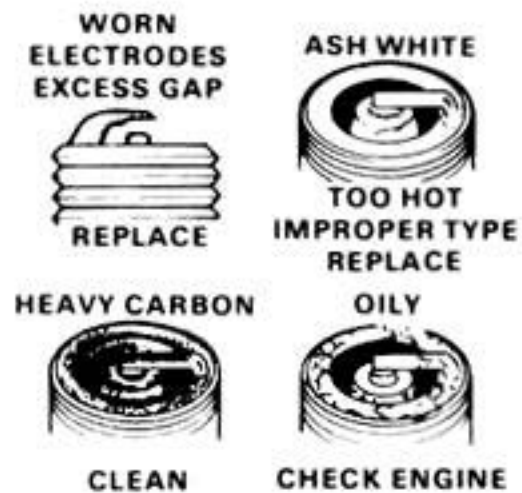

## 3. Adjusting

### CAUTION

Never attempt to bend the center electrode. This will crack the insulation and ruin the spark plug.

- Set gap to .028 inch by bending the side electrode.
- Check gap with the .028 inch wire gauge. The gauge should pass through the gap with slight drag.

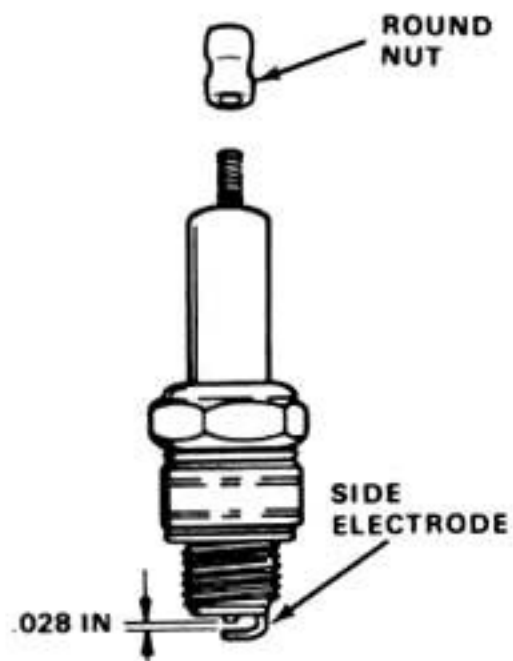



#### 4. Installing Spark Plugs

- a. If the spark plug has a round nut on the threaded end, remove the nut. This nut is not used in your VW.
- b. Place spark plug into socket wrench. Apply lead of a soft pencil to threads as a lubricant.

##### CAUTION

Do not use the T-handle and extension to start plug into cylinder head. This could crosstread the plug and damage the head.

- c. Place plug in socket. Position plug in opening of cylinder head. Thread plug in by hand until seated as far as it will go.

##### CAUTION

If torque wrench is not used, do not use a wrench handle longer than 8 inches. Using a longer handle could cause you to overtighten the plug and damage the head.

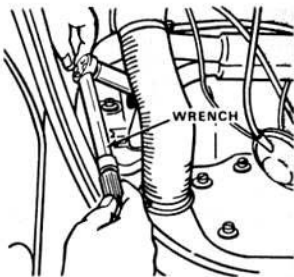

- d. If a torque wrench is available, tighten plugs to 22 to 29 foot pounds. If a torque wrench is not available, use an 8-inch T-handle and extension.
- e. Push connector onto spark plug. Be sure all rubber boots and round rubber seats are properly positioned.

#### Pages 41, 42, 43 and 129

The valve clearance as listed on these pages should be changed to read 0.006 inch (0.15 mm).

### Valve Clearance

#### Tools Needed

Breaker bar handle or wheel cover remover  
Screwdriver,  $\frac{7}{16}$  inch blade  
Feeler gauge, flat type, 0.004 inch  
Box wrench, 13 mm

#### Materials Needed

2 valve cover gaskets, VW Part No. 113 101 481E  
Cleaning solvent

Valve clearance is the gap between the valve stem and the adjusting screw. This clearance should be adjusted at regular intervals. If valve clearance is too great you will hear a clattering noise when the engine is running. Too little clearance is more serious since it will produce no perceptible warnings. Wrong clearance will cause the following:

**Pages 41, 42, 43 and 129**

The valve clearance as listed on these pages should be changed to read 0.006 inch (0.15 mm).

**Too Little Clearance**

- Burning of valves and valve seats
- Distortion of valves
- Poor performance
- Rough engine running
- Changed valve timing
- Change in exhaust emission

**Too Much Clearance**

- Noisy timing mechanism
- Rough engine running
- Poor performance
- Changed valve timing
- Change in exhaust emission

**NOTE**

The valve clearance for both the intake and the exhaust valve should be .004 in. (0.10 mm), the clearance is shown on a label on the fan housing.

**1. Adjusting Valve Clearance**

- a. Set parking brake. Make sure transmission is in neutral.

**NOTE**

Valve clearance must be checked and adjusted when engine is cold.

- b. Loosen two clips on distributor cap. Remove cap.
- c. Turn engine until smaller side of rotor points to mark on distributor housing. Use a socket wrench and T-bar or turn fan belt by hand. This mark is for No. 1 cylinder. Check that mark on crankshaft pulley is in line with split in engine case.

**NOTE**

Adjust valves in cylinder order 1-2-3-4. The cylinder arrangement is shown by numbers on the engine cover plates on either side of the engine. The piston of the cylinder to be adjusted must be at Top Dead Center (TDC) of its firing stroke (both intake and exhaust valves closed).

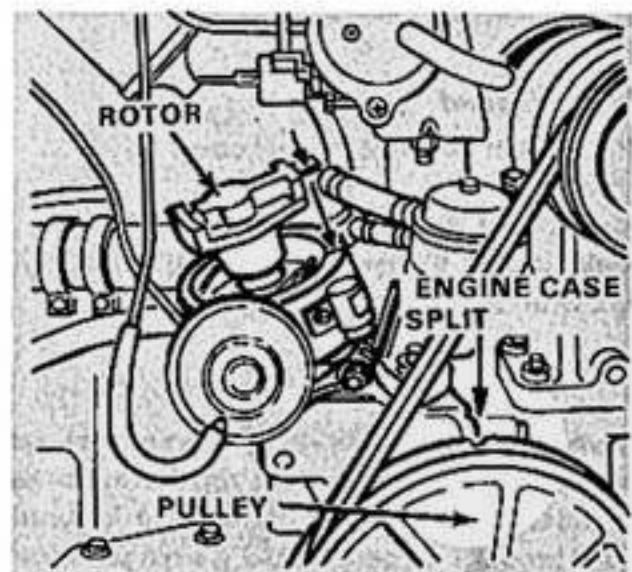
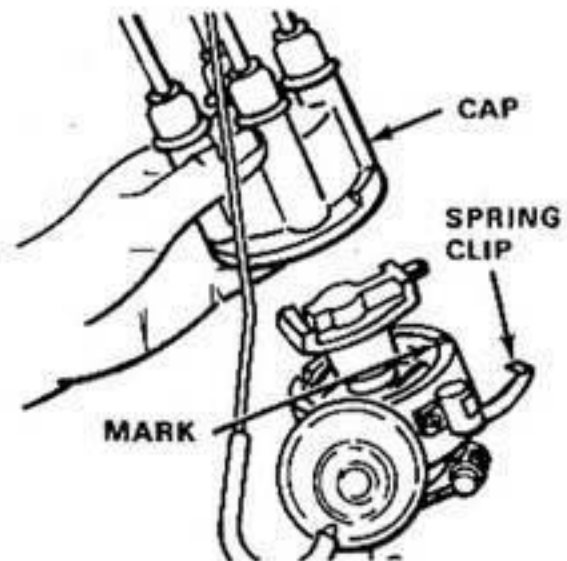

The valve clearance as listed on these pages should be changed to read 0.006 inch (0.15 mm).

- d. Remove valve cover on bottom-right side of engine by inserting breaker bar handle through center hoop of retaining spring. Pull down on handle until spring is free.
- e. Jiggle rocker arms to make sure both valves have a small amount of play. This indicates that cylinder is at Top Dead Center.
- f. Insert .004 inch blade of feeler gauge between adjusting screw and valve stem of both No. 1 cylinder valves. If the blade can be slid between screw and stem quickly and smoothly with a slight drag, the adjustment is good. If adjustment is good, go to step j. If not, go to step g.
- g. Using the 13 mm wrench, loosen lock nut on adjusting screw of valve requiring adjustment. Adjust clearance by turning adjusting screw with a screwdriver until there is slight drag on the feeler gauge blade.
- h. When clearance is good, hold adjusting screw with screwdriver and tighten locknut.
- i. After tightening locknut, check clearance again. If it has changed, readjust clearance.
- j. Turn engine until the smaller side of rotor is pointing 90° counter-clockwise to mark on distributor. Check that both No. 2 cylinder valves have a small amount of play.
- k. Repeat steps e. thru i. for the No. 2 cylinder valves. If the clearance is good in step f., go to step l.

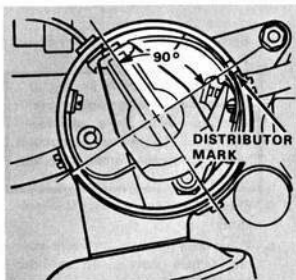
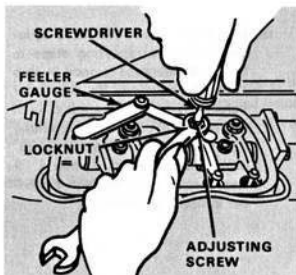
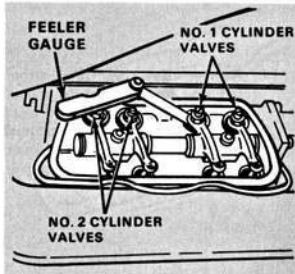

- l. Remove valve cover from bottom left side of engine. Turn engine until smaller side of rotor is pointing  $180^\circ$  to mark on distributor. Check that mark on crankshaft pulley is in line with split in engine case.

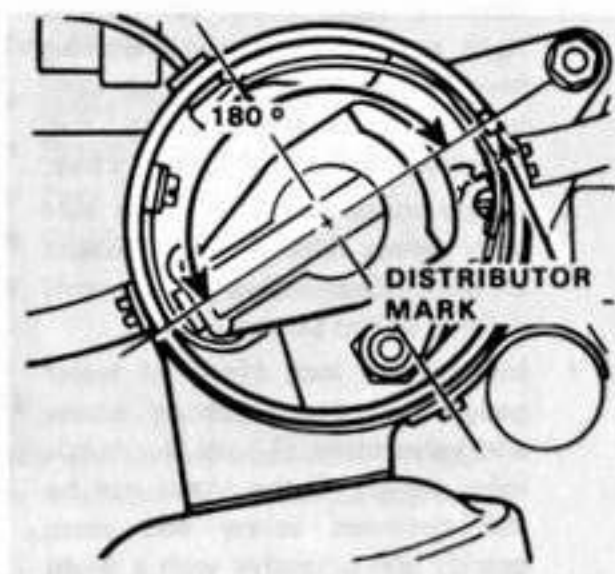

- m. Check and adjust the No. 3 cylinder valves by repeating steps e. thru i. If clearance is good in step f., check and adjust No. 4 cylinder valves by turning engine until smaller side of rotor is pointing  $90^\circ$  clockwise to mark on distributor. Repeat steps e. thru i. If clearance is good for No. 4 cylinder in step f., go to step n.

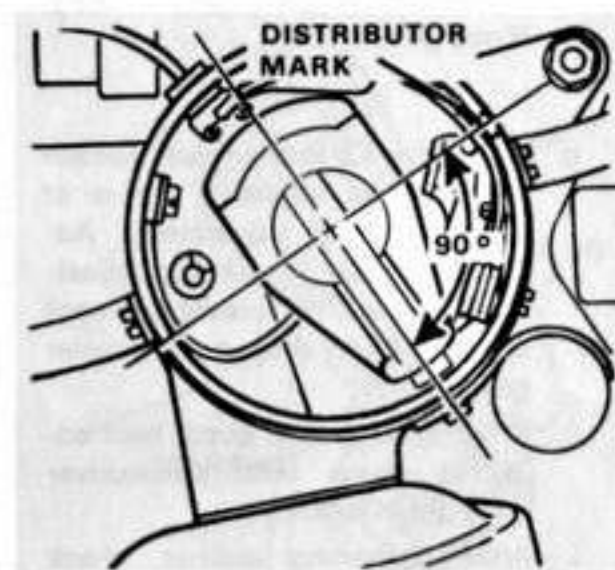

- n. Remove gaskets from valve cover. Throw away old gaskets.

**WARNING**

Be very careful when cleaning with solvents. Work in a well-ventilated area. Do not use equipment that can ignite fumes. Do not smoke.

- o. Clean the valve cover. Use solvent.  
p. Place new gaskets on valve covers. Place covers on cylinder heads.

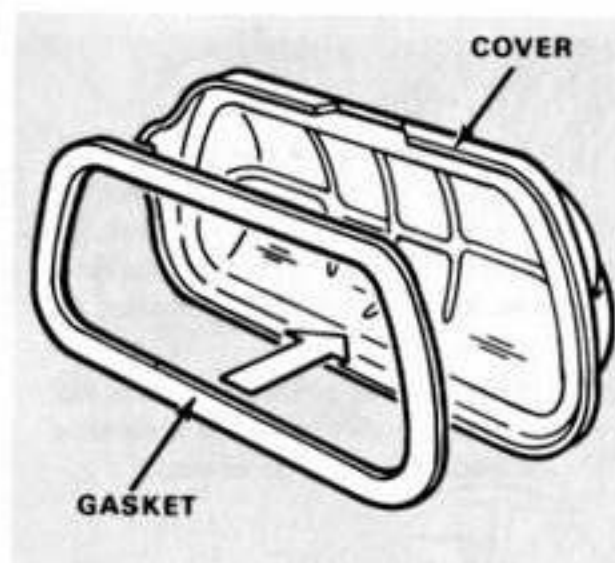

- q. Push retaining springs into place on covers. Use jack bar handle to lift spring into place if necessary. Tap cover around edge with a screwdriver handle to make sure gasket is seated.
- r. Start car and drive to a ventilated area. Let it run for a few minutes. Shut off engine and check for leaks around valve covers. If there are leaks, remove covers and check the gaskets. Replace any damaged gaskets. Install the covers.

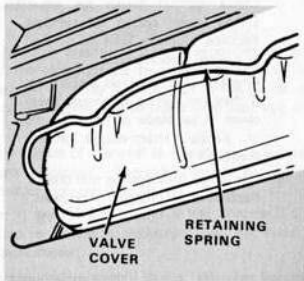

## Ignition Distributor

The distributor, as its name implies, distributes the ignition spark to the spark plugs at the right time and in the right sequence. Therefore, the slightest irregularity (such as bad points, incorrect adjustment, corrosion, etc.) in the operation of the distributor can result in very poor engine performance and adversely change the exhaust emission.

### **Tools Needed**

Clean cloth  
Pocket knife or sharp-edged instrument

### **Materials Needed**

None

### 1. Removing and Inspecting Distributor Cap

- a. Release retaining clips and lift cap off distributor.
- b. Wipe off both the inside and outside of cap.

#### **NOTE**

If you are going to disconnect any wire from the cap, mark both the wire and the cap to be sure wire is returned to its correct position.

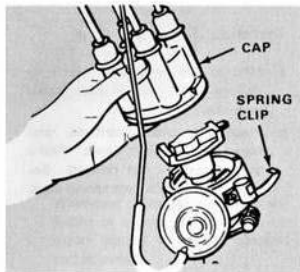

- c. Check carbon brush for wear. Check brush spring for tension. Replace a spring with no tension or a worn carbon brush.
- d. Check metal terminals inside cap. If they are corroded, scrape them clean. Use blade of pocket knife or similar sharp-edged instrument.
- e. Check cap for chipping and cracks. Replace cap if chipped or cracked.

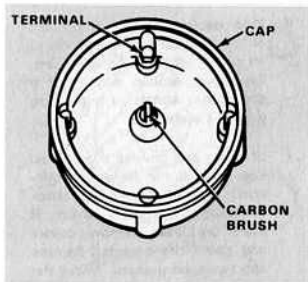

## 2. Removing and Inspecting Distributor Rotor

- a. Pull rotor up off the shaft.
- b. Wipe off rotor. Check for chipping, cracks, or irregular black lines. If any of these are present, replace rotor.
- c. If tip of the metal conductor strip is corroded, scrape it clean. Use the pocket knife blade.

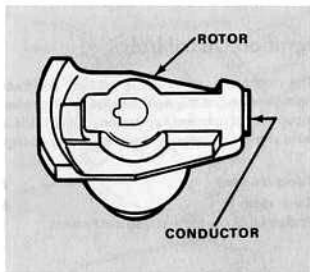

## 3. Installing Rotor and Cap

- a. Line up keyway inside rotor with slot in shaft. Slide rotor down over shaft, until seated.
- b. Place cap over distributor and move cap until it seats. Make sure wires are not twisted. Secure cap with the two spring clips.

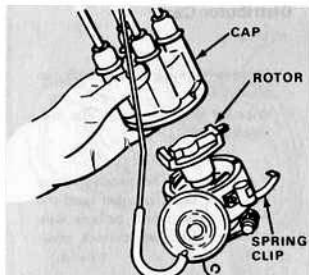

## Distributor Contact Breaker Points

The distributor contact breaker points play a vital role in the ignition system of your Volkswagen. The correct functioning of the ignition system in turn is important for the complete burning of the fuel/air mixture and, therefore, affects to a great extent the exhaust emission. Before we go on to describe how to make adjustments to the points, or replacing them, or changing the ignition timing, we would like to make sure that you are properly prepared.

During the operation of the engine, a certain amount of material is transferred from one point to the other. This transferring reduces efficiency. Therefore, points should be checked every 6,000 miles and cleaned, adjusted, or replaced if necessary.

To effectively adjust the ignition timing after it was changed (and it will change if the position of the points are changed by cleaning, adjusting or replacing), you will need a stroboscopic timing light, a dwell meter and a tachometer.

These instruments can be purchased at most automotive supply stores. We urge you not to attempt the adjustment with a make-shift arrangement. Unless you are properly equipped, this work should be done by your Volkswagen dealer or other properly equipped workshop.

### **Tools Needed**

Pocket knife  
Piece of cardboard (matchbook cover or business card)

### **Materials Needed**

None

### **1. Checking Contact Breaker Points**

- a. Remove distributor cap by releasing retaining clips and lifting cap off. Pull rotor up off the shaft.
- b. Check contact breaker points. If they are highly polished and show a gray or silvery coloring, the points are good.
- c. If points are burnt or have a bluish coloring, replace them. This condition indicates a bad condenser or ignition coil. Most of the time it will be the condenser that is bad. See Condenser, page 50.
- d. If points have dirt, oil, or grease on them, scrape them clean. Use the pocket knife blade. Do not use a file or emery cloth. After scraping, clean points by sliding cardboard between them while pressing them slightly together.

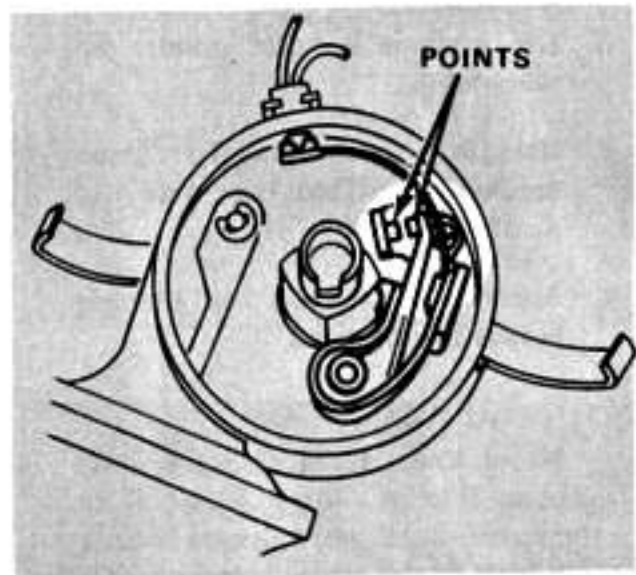

### **NOTE**

Whenever point gap (dwell) is adjusted or points are replaced, ignition timing must be checked and adjusted.

## 2. Replacing Contact Breaker Points

When adjustment of points is no longer possible or if points are badly burnt, they should be replaced.

### NOTE

For your convenience you may want to remove the distributor when replacing the points. For removal of the distributor, see Removing and Installing Condenser, page 50.

#### Tools Needed

Piece of cardboard (matchbook cover or business card)  
Clean cloth

#### Materials Needed

Set of distributor contact breaker points, VW Part No. 311 998 063  
Lithium grease

- Remove distributor cap by releasing retaining clips and lifting cap off. Pull rotor up off the shaft.
- Pull cable connection up off terminal.
- Remove contact retaining screw and washer.
- Lift contact breaker points out completely.
- Using a clean cloth, carefully clean breaker plate and cam lobes of distributor shaft.
- Apply a light coat of Lithium grease to cam lobes.

#### CAUTION

Never touch faces of points with your fingers. Make sure oil or grease does not contact points (Clean feeler gauge blades.). Oil or grease could cause the points to burn or misfire.

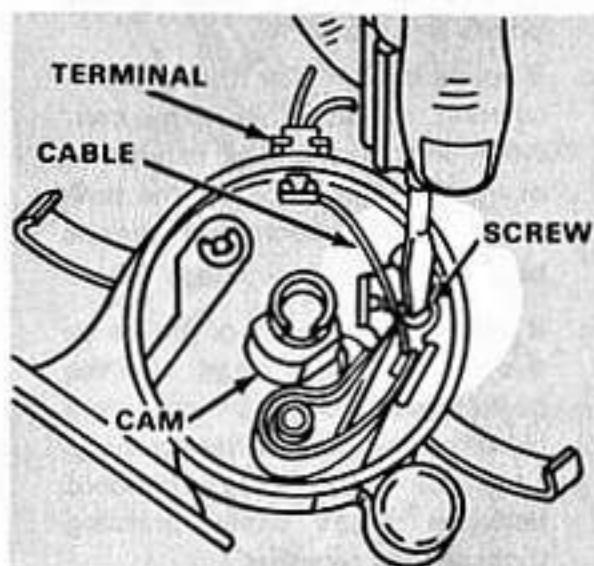
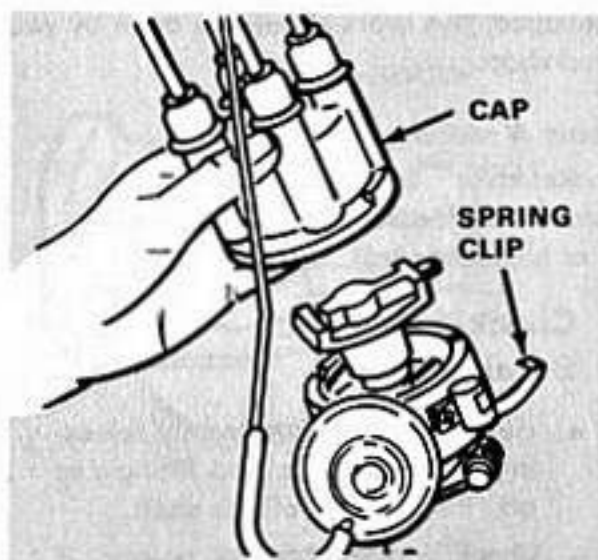



- g. Before installing, clean contact points by sliding cardboard between them while pressing them slightly together.
- h. Place points on breaker plate. Make sure shaft is in hole in plate. Install retaining screw and washer. Push cable connection on terminal.
- i. Adjust contact breaker gap. See *Adjusting Contact Breaker Points*.

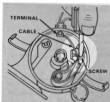

### 3. Adjusting Contact Breaker Points

#### Tools Needed

Screwdriver, 3/16 inch blade

Feeler gauge, 0.016 inch

- a. Remove distributor cap by releasing retaining clips and lifting cap off. Pull rotor up off the shaft.
- b. Turn engine over until rubbing block is on highest part of cam lobe. Use a socket wrench and ratchet or turn the fan belt by hand.
- c. Loosen retaining screw of the fixed contact point.
- d. Place the screwdriver between the two small pins on breaker plate and in slot at end of fixed point. Twist screwdriver until gap between points is 0.016 inch. Use the feeler gauge to check gap.
- e. Tighten retaining screw. Recheck point gap and readjust if necessary.

#### NOTE

Whenever point gap (dwell) is adjusted, the ignition timing must be checked and adjusted.

#### Materials Needed

None



## Condenser

### Tools Needed

- Screwdriver,  $\frac{7}{16}$  inch blade
- Socket, 13 mm,  $\frac{3}{8}$  inch drive
- Extension, 6 inch,  $\frac{3}{8}$  inch drive
- Handle (ratchet, T-bar, etc.)  $\frac{3}{8}$  inch drive

### Materials Needed

Condenser VW Part No. 113 905 295C

### 1. Removing Condenser

- Pull green wire connector off terminal on coil.
- Remove distributor cap by releasing retaining clips and lifting cap off.
- Pull both vacuum hoses (black and green) off distributor.
- Turn engine until rotor is in line with mark on distributor. Use a socket wrench and T-bar or turn fan belt by hand.
- Using a 13 mm socket wrench, remove nut and washer holding distributor to crankcase.

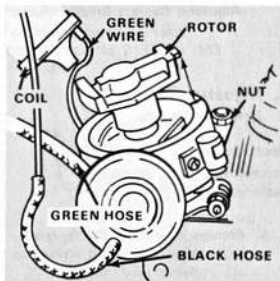

- Lift distributor out of engine.

### NOTE

Do not turn engine with the distributor removed.

- Remove screw and washer securing condenser wire bracket in distributor.
- Remove screw and washer securing condenser to distributor body. Remove condenser.

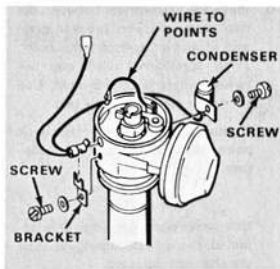

## 2. Installing Condenser

- a. Place condenser against distributor body. Install screw and washer and tighten screw.
- b. Place plastic plug in distributor housing. Place bracket into slots of plastic plug. Install screw and washer and tighten screw.

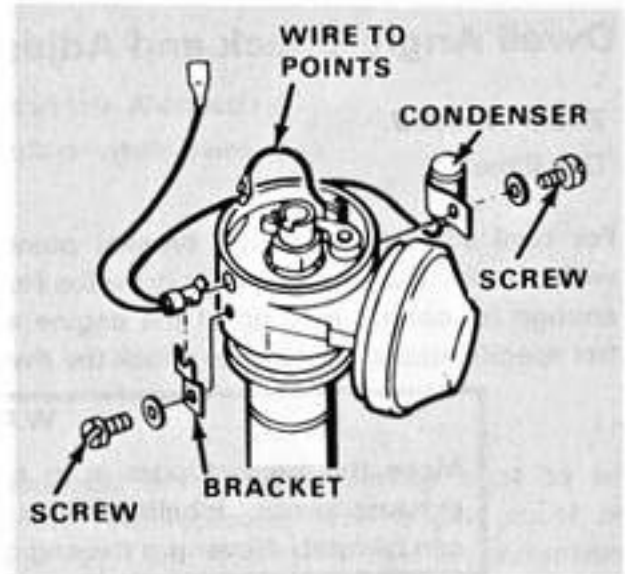

- c. If engine has been turned with distributor out, turn engine until slot in distributor drive is pointing right to left. Make sure slot is offset to rear of car. Check that notch on pulley is in line with split in crankcase.
- d. Turn rotor until smaller face of rotor is in line with mark on distributor.
- e. Place distributor into crankcase. Position distributor holding clamp over bolt in crankcase.
- f. Make sure distributor is fully seated. It may be necessary to turn the rotor slightly to line up the distributor shaft with the drive.
- g. Install nut and washer on bolt through holding clamp. Using the 13 mm socket wrench, tighten.
- h. Place cap on distributor. Secure cap with the two spring clips.
- i. Install green vacuum hose on front adapter. Install black hose on rear adapter.
- j. Install green (primary) wire on coil terminal.

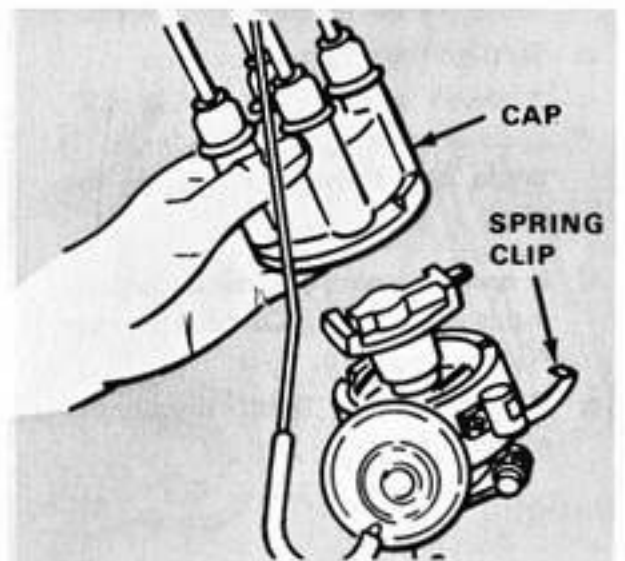
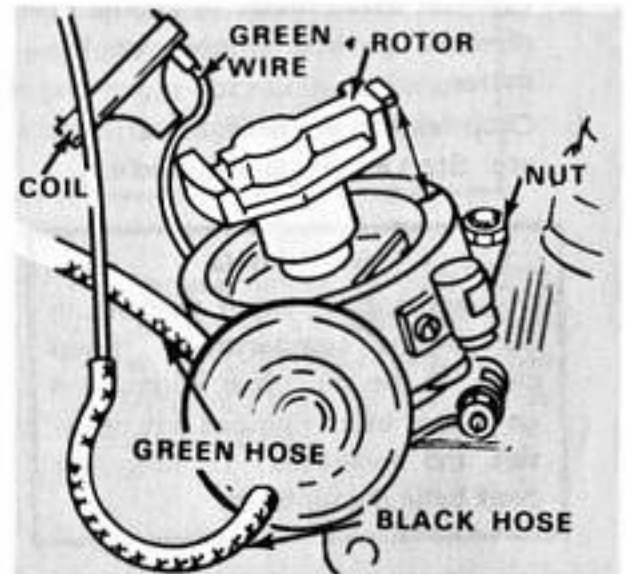

## Dwell Angle Check and Adjustment

### Tools Needed

Dwell meter

### Materials Needed

None

For final adjustment of the breaker point gap, a dwell meter is necessary. Adjustment with a feeler gauge alone only provides for the basic adjustment. This will not be accurate enough for correct running of the engine and reaching the required exhaust emission control specifications. In order to check the dwell, the engine must be running.

### WARNING

Move the car outdoors or in a well ventilated area. Avoid inhaling exhaust fumes. Inhaling fumes can cause loss of consciousness and can be fatal. Never run the engine in an enclosed area.

- Connect dwell meter to engine as directed in instructions for the meter.
- Clear engine area of tools, rags, etc. Start engine and let it idle.

### WARNING

Be very careful when working in the engine compartment. Keep clear of the electrical wiring and generator belt. Remove any neckties and necklaces. Tie long hair back behind your head.

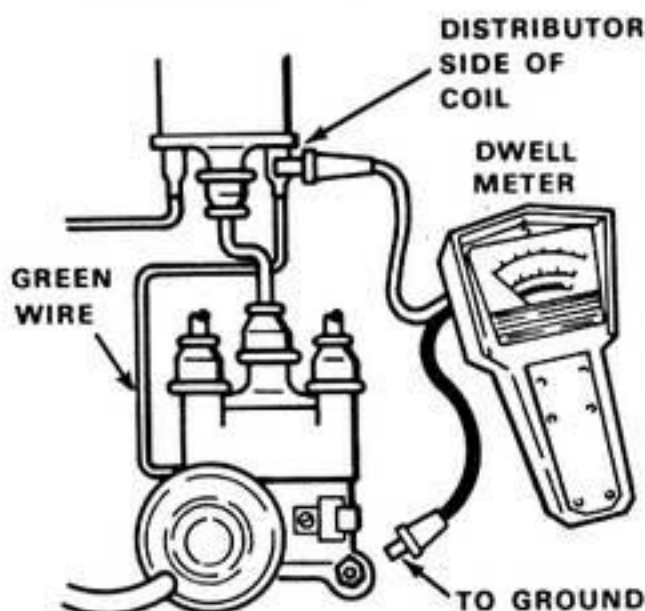

- Read dwell angle on the meter. It should be between  $44^\circ$  and  $50^\circ$ .
- Turn off the engine.
- If dwell angle was below  $44^\circ$ , breaker point gap is too large. If angle was above  $50^\circ$ , gap is too small.
- If breaker point gap needs adjusting, see Adjusting Contact Breaker Points, page 49.
- If gap is set right, disconnect meter.

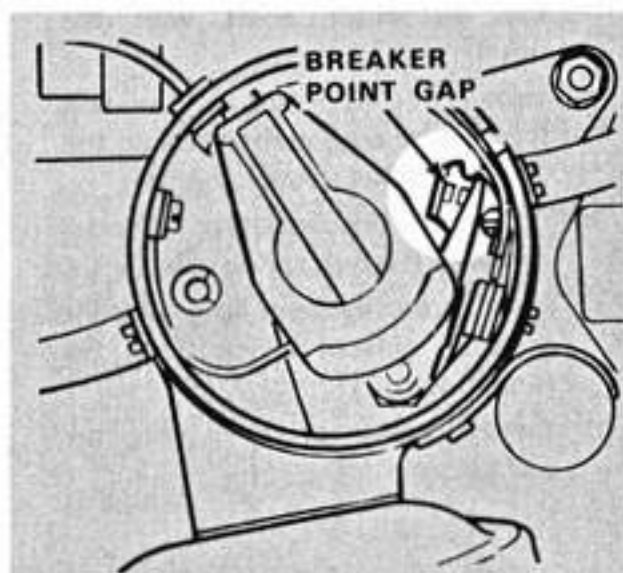

## Ignition Timing Procedure

### Tools Needed

Stroboscopic timing light  
Screwdriver  
Sliding T-handle,  $\frac{3}{8}$  inch drive  
Socket wrench, 10 mm,  $\frac{3}{8}$  inch drive  
Extension, 6 inch,  $\frac{3}{8}$  inch drive  
Tachometer  
Ruler, 6 inch

### Materials Needed

Chalk or white paint

Ignition timing must be checked with a stroboscopic timing light. Timing must be set whenever point gap (dwell) is adjusted or points are replaced. The engine must be warmed up until the oil temperature is between 122° and 158°F. When the automatic choke is fully open, or after about 15 minutes running, the engine is sufficiently warm.

### WARNING

Be very careful working around the engine when it is running. You will have to work close to the fan belt and might not realize it is moving. Remove any neckties and necklaces. Tie long hair back behind your head.

- Connect tachometer and timing light to engine as directed in the instructions for them.

### NOTE

If the timing light cannot be connected to the spark plug connector, connect the light to the No. 1 cylinder wire at the distributor.

### NOTE

The correct timing for your 1972 VW Sedan is 5° after top dead center (ATDC). This setting can be found on a label on the left side of the fan housing.

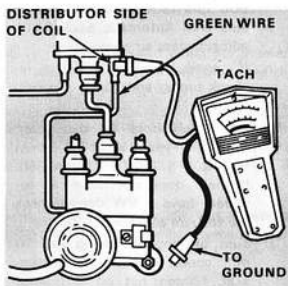
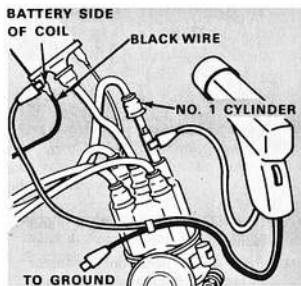

The V-shaped notch in the pulley is the actual 5° After Top Dead Center mark to be used for the setting of the ignition timing. Do NOT make a mark to the left of the notch as illustrated (top illustration) and described in paragraph b.

- b. Measure  $\frac{1}{16}$  inch to left of mark on crankshaft pulley. Make a mark on pulley. Use chalk or white paint. This mark is the 5° ATDC mark.
- c. Using the 10 mm socket wrench and extension, loosen nut securing distributor. Do not remove nut.
- d. Start the car. Set idle speed to 800 to 900 rpm (900 to 1000 rpm on cars with Automatic Stick Shift) on the tachometer by turning the bypass air screw on the carburetor. See Carburetor Idle Speed Adjustment, page 55.

**NOTE**

If idling speed cannot be set between 800 and 900 rpm (900 to 1000 rpm on cars with Automatic Stick Shift), ignition timing is probably incorrect.

- e. Aim timing light at split in crankcase and top of pulley. Timing is good when the 5° ATDC mark is in line with the split.
- f. If mark is not in line with split, rotate distributor until mark and crankcase split are in line.
- g. Check engine speed with tachometer. If it is not between 800 and 900 rpm (900 to 1000 rpm on cars with Automatic Stick Shift), adjust bypass air screw.
- h. If engine speed is adjusted, recheck timing and adjust if necessary.
- i. Pull green hose off distributor. Check that mark on pulley moves  $\frac{1}{32}$  to  $\frac{3}{32}$  inch to the left. If mark does not move as required, have a VW dealer check the vacuum advance system.
- j. Turn off engine. Using the 10 mm socket wrench and extension, tighten nut on distributor clamp.

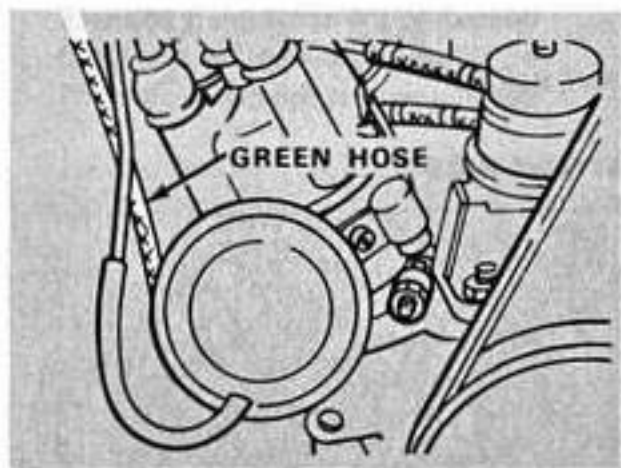
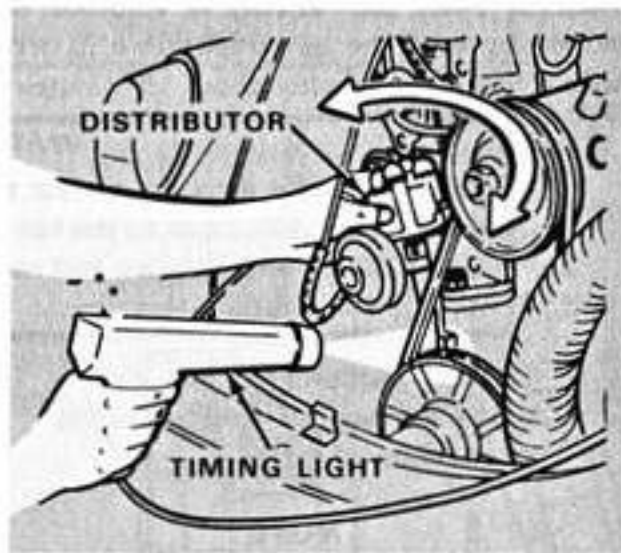
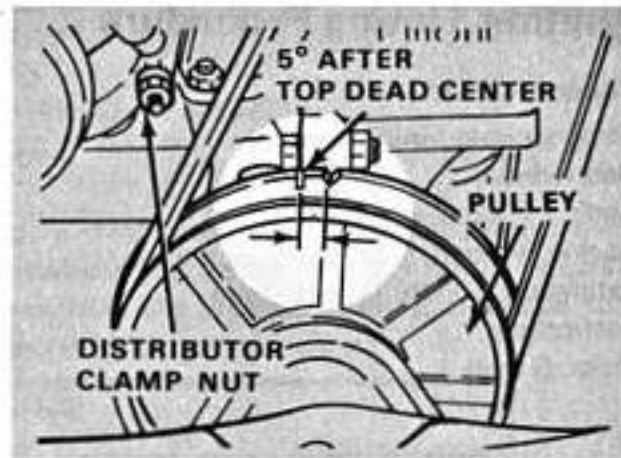

- k. Disconnect timing light and tachometer.
- l. Push green hose on distributor fitting. Recheck timing to make sure it has not changed.

## Carburetor Idle Speed Adjustment

The idle speed is adjusted by the bypass air screw. This adjustment must be done when the ignition timing is set. See Ignition Timing Procedure, page 53.

### CAUTION

Do not turn the timing screw or the volume control screw to adjust the idle speed. These screws are set during manufacture and should not be changed. If the carburetor needs to be repaired have your WV dealer do it. He is properly equipped and trained to handle the repair.

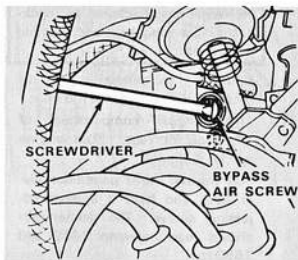

## Throttle Valve Positioner

### **Tools Needed**

Screwdriver,  $\frac{7}{16}$  inch flat blade  
Tachometer  
Watch with sweep second hand

### **Materials Needed**

None

The throttle valve positioner delays the closing of the throttle valve when the accelerator (gas) pedal is released. This maintains the proper fuel and air to the engine so that all the fuel is burned.

The throttle valve positioner consists of two parts. The control part is located at the left rear of the engine compartment. The operating part is mounted on a bracket on the carburetor flange. The throttle valve positioner is not installed on cars with Automatic Stick Shift Transmission.

Before trying to check the throttle valve positioner, check the engine idle and, if necessary, adjust it. See Ignition Timing Procedure, page 53. The engine must be warmed up before checking the throttle valve positioner.

## 1. Checking Fast Idle

### WARNING

Be very careful working around the engine when it is running. Remove any neckties or necklaces. Tie long hair back behind your head.

- Connect tachometer as directed in instructions for meter.
- Clear engine compartment of any tools or rags. Start engine and let it idle.
- Pull throttle valve positioner lever back and hold it against adjusting screw. The tachometer should read between 1450 and 1650 rpm.
- If reading was not between 1450 and 1650 rpm turn adjusting screw to set speed.
- If throttle valve positioner was adjusted, take the car for a test drive. Then recheck setting as directed in steps a, b, and c. The tachometer reading must not exceed 1700 rpm. If it does, readjust the throttle valve positioner.

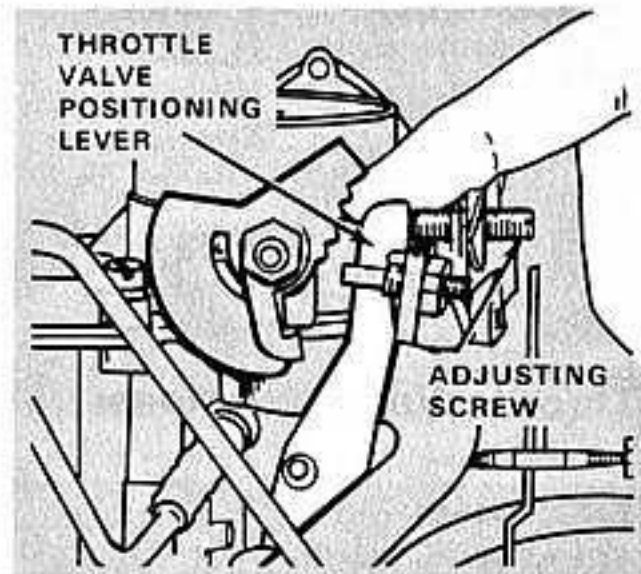
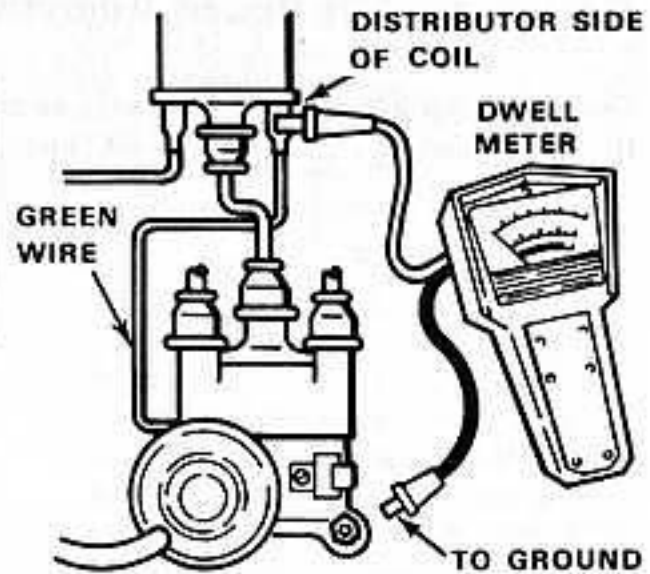

## 2. Checking and Adjusting Throttle Valve Closing Time

- With tachometer still connected, pull throttle valve lever back until tachometer reads 3000 rpm.
- Note the second hand position on your watch. Release throttle valve lever and check the time it takes tachometer to drop to between 800 and 900 rpm. This is the closing time.

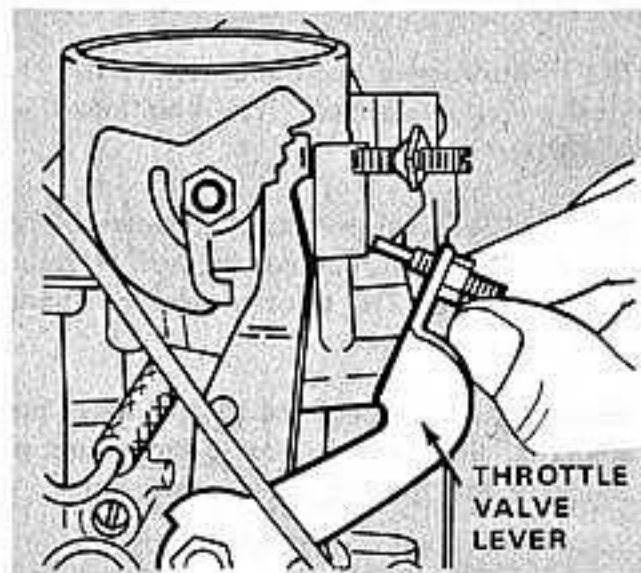



- c. The closing time must be between  $2\frac{1}{2}$  and  $4\frac{1}{2}$  seconds. If it is not, loosen the set screw on the control.

#### NOTE

Turn screw to the right (clockwise) to increase closing time. Turn screw to the left (counterclockwise) to decrease closing time.

- d. Recheck closing time. If it is good, tighten the setscrew. Disconnect tachometer.
- e. Take the car for a test drive. Recheck the closing time. The closing time must not exceed 6 seconds. If it does, adjust once again.
- f. Shut off engine.

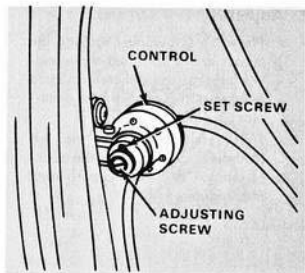

## V-Belt

### Tools Needed

Socket wrench,  $1\frac{7}{16}$  inch,  $\frac{3}{8}$  inch drive  
 Sliding T-handle,  $\frac{3}{8}$  inch drive  
 Screwdriver,  $\frac{3}{8}$  inch  
 Torque wrench, 0 to 150 foot-pounds,  
 $\frac{3}{8}$  inch drive

### Materials Needed

V-belt, VW Part No. 111 903 137 D  
 or equivalent  
 Wrapping plastic or paper

The V-belt drives the engine cooling fan and generator. Therefore it is very important that the belt be in good condition and properly adjusted. A spare belt should always be carried in the car. If the belt shows signs of excessive wear, fraying or cracking, it should be replaced.

The V-belt is adjusted by changing the gap between the plates of a two-piece pulley. Adding spacers opens the gap between the plates and loosens the belt. Removing them closes the gap and tightens the belt.

### 1. Checking Tension

#### WARNING

Be sure ignition switch is off and gearshift is in neutral. Set parking brake.

- a. Open engine hood.
- b. Press V-belt inward at the center with your thumb. Tension is correct when belt moves only about  $\frac{1}{4}$  inch.

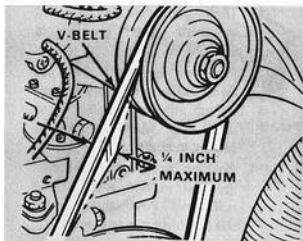

## 2. Adjusting

- a. Place the screwdriver through the cutout in the front half of the pulley (next to the generator). Hold it against the bolt in the generator housing.
- b. Turn retaining nut to the left (counterclockwise) with the socket wrench and bar. Loosen until fingertight.

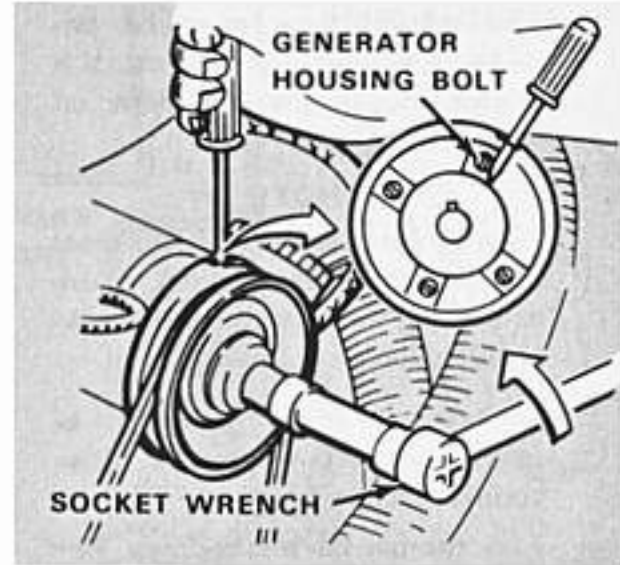

- c. Remove retaining nut, retainer, washers, and rear half of pulley from generator shaft.

### NOTE

The front pulley half is locked to the generator shaft by a woodruff key (half-moon shaped piece of metal). Sometimes when pulley half is removed, the front pulley half may slide off the woodruff key. If this happens, do the following:

- (1) Turn generator shaft until woodruff key groove is straight up.
- (2) Position woodruff key in generator shaft groove so that its top edge is parallel to the shaft axis. Make sure key is seated in shaft.
- (3) Position groove in front pulley half in line with woodruff key. Push pulley over the key until it is seated.

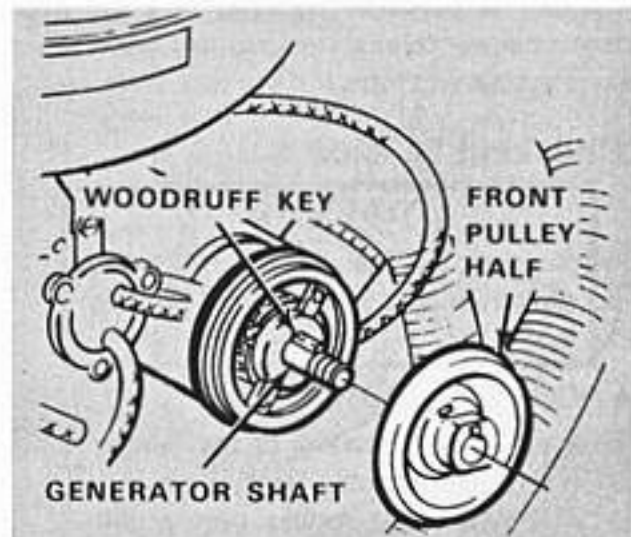
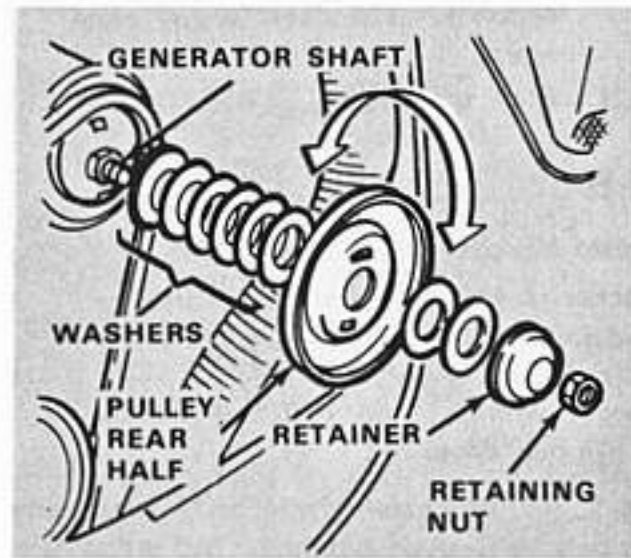

- d. Change the number of washers between pulley halves to adjust belt tension. Remove washers to tighten belt. Add washers to loosen belt.
- e. Install rear half of the pulley. Make sure the large tab is in line with the large opening in opposite pulley half. Place extra washers on the shaft outside the rear half of the pulley.

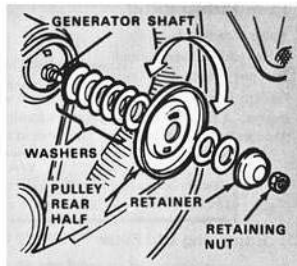

- f. Place the screwdriver through the cutout in front half of pulley, and hold it against bolt in generator housing.
- g. Torque retaining nut to 40 to 47 foot pounds.

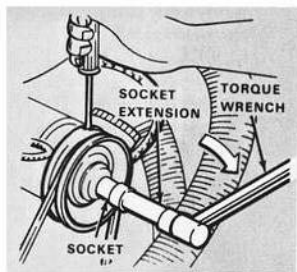

### 3. Replacing Belt

- a. Remove 3 screws holding crankshaft pulley cover plate.
- b. Remove generator rear pulley half as described in steps 2.a. through 2.c. above.
- c. Remove old belt.
- d. Install new belt on crankshaft pulley and place it over shaft of generator pulley.
- e. Install generator rear pulley half. Adjust belt as described in 2.d. through 2.g. above.
- f. Install crankshaft pulley cover plate. Secure it with the 3 screws.
- g. Close engine hood.

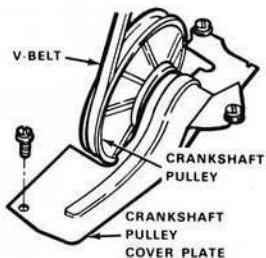

## Fuel Pump Filter

### Tools Needed

Offset screwdriver,  $\frac{3}{16}$  inch  
Fuel line clamp

### Materials Needed

Filter kit, VW Part No. 111 198 555 1A

Foreign matter, such as dust or dirt and water in the fuel can damage your carburetor and engine. A fuel pump filter prevents foreign matter and water from entering the carburetor through the fuel system. The filter should be replaced every 6,000 miles.

### WARNING

Disconnect ground connector from battery to prevent sparking. Never smoke or have anything in the area that can ignite fuel.

## 1. Removing Old Filter

- a. Open engine hood.
- b. Install fuel shut off clamp on the flexible tubing extending from the fuel line to stop flow.
- c. Remove screw from the top of fuel pump. Take off the cover, gasket, and filter.

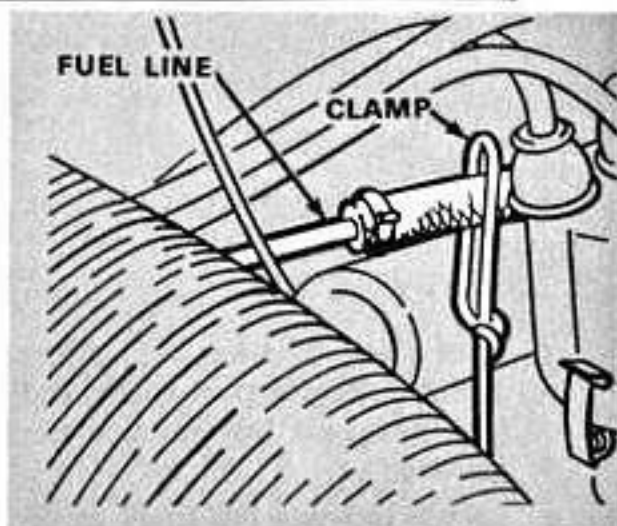

## 2. Installing New Filter

- a. Insert new filter in pump.
- b. Install new cover gasket. Make sure it is located properly.
- c. Install cover and secure with retaining screw.
- d. Remove fuel shut off clamp.
- e. Start engine and check for fuel leaks around cover. If you see any leaks, shut off engine, and clamp fuel line again. Remove the pump cover and correct gasket positioning. Perform running check again.
- f. Shut off engine.
- g. Close engine hood.

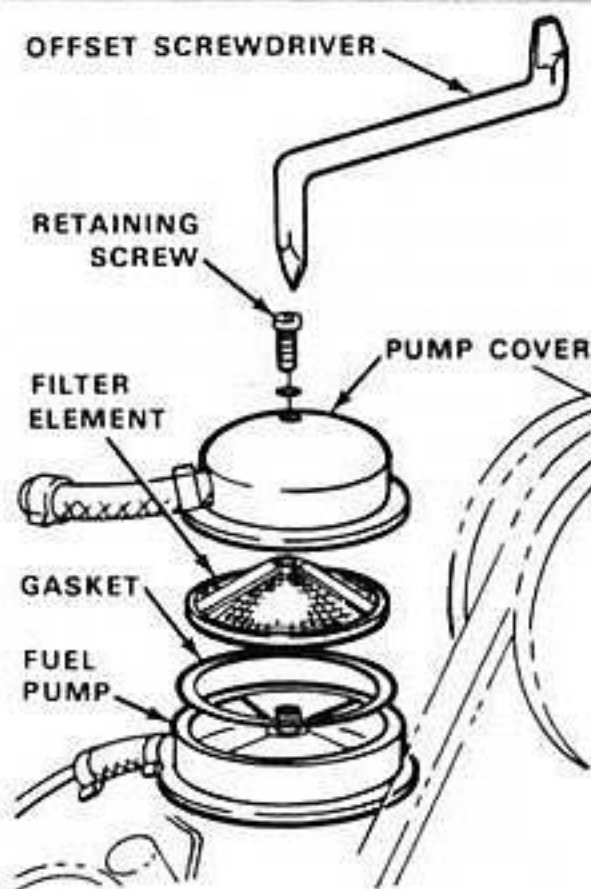

## Clutch Pedal Free Play

### Tools Needed

Ruler  
Pliers  
Support stand

### Materials Needed

None

In order to assure the correct engagement or disengagement of the clutch, proper adjustment of the clutch pedal free-play is necessary. Normal clutch wear will cause free-play to change. Therefore, the clutch should be checked every 6,000 miles.

### NOTE

The Super Beetle with automatic stick shift has no clutch pedal.

## 1. Checking

- Open left car door.
- Place a ruler above clutch pedal with end against toe board. Note distance of clutch pedal from toe board.
- Push pedal until clutch pressure is felt. Movement should be between  $\frac{3}{8}$  and  $\frac{3}{4}$  inch. If it is not, adjust the cable.
- Close car door.

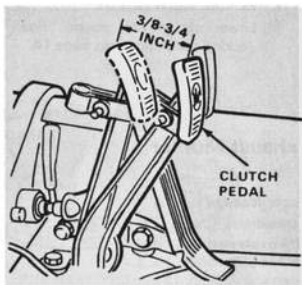

## 2. Adjusting

- Drive the car to a level area.

### WARNING

Follow jacking procedures in Chapter 4, Jacking and Supporting, page 14. Do not work under the raised car until it is on support stands.

- Remove left rear wheel. See Removing a Wheel, page 105.
- Position support stands under car. Refer to Chapter 4, Jacking and Supporting, page 14.
- Adjust cable by holding cable end tightly with pliers and turning wing nut.

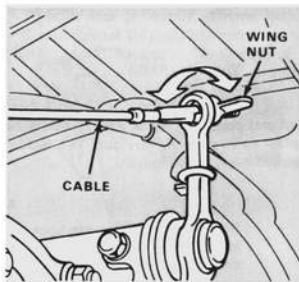

### NOTE

Turning wing nut counterclockwise shortens pedal free play. Turning it clockwise increases it.

- e. After adjusting, be sure wing nut is left with the wings horizontal so that lugs on nut engage recesses in clutch lever.
- f. Operate clutch pedal several times. Check adjustment.
- g. Install wheel and hub cap. See *Installing a Wheel*, page 106.
- h. Raise the car off the support stands.
- i. Remove support stands.
- j. Lower car to the ground. See *Jacking and Supporting*, page 14.

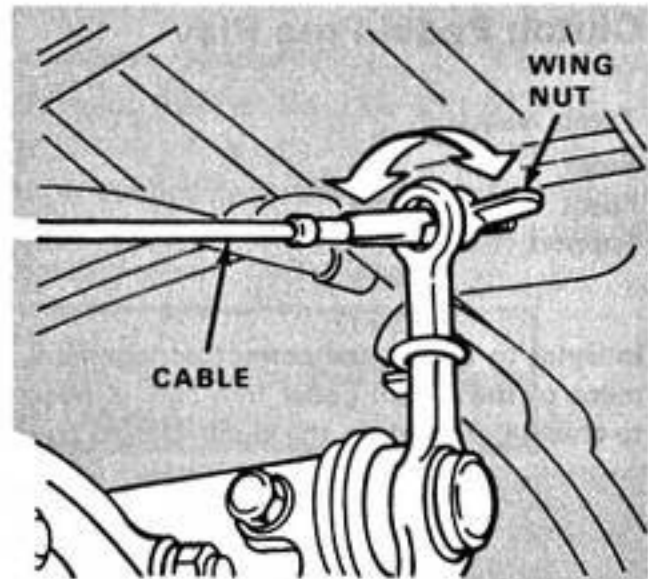

## Exhaust Muffler

### Tools Needed

Screwdriver,  $\frac{3}{8}$  inch  
Phillips screwdriver, no. 2  
Phillips screwdriver, no. 3  
Open end wrench, 13 mm (2)  
Open end wrench, 10 mm  
Box wrench, 10 mm  
Socket wrench, 10mm,  $\frac{3}{8}$  inch drive  
Torque wrench, 0 to 150 foot-pounds,  
 $\frac{3}{8}$  inch drive  
Drift pin,  $\frac{1}{4}$  inch

### Materials Needed

Exhaust muffler repair kit, VW Part  
No. 111 298 009  
Penetrating oil

Rust and corrosion attack a muffler both inside and outside. Short drives do not allow the muffler to heat up and dry out. This increases wear of the muffler. The muffler should be checked every 6,000 miles.

### NOTE

If you own an Automatic Stick Shift vehicle which was delivered in California, your exhaust muffler contains an additional part for the emission control. If muffler needs replacing, have it done by your VW Dealer.

## 1. Removal

- a. Raise engine hood.
- b. Pull off pre-heater hose.
- c. Using the no. 2 screwdriver, loosen heater hose clamps. Remove hoses. Remove hose adapters and grommets at the same time.

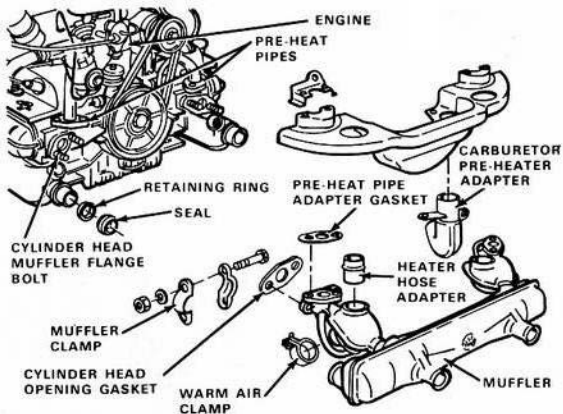
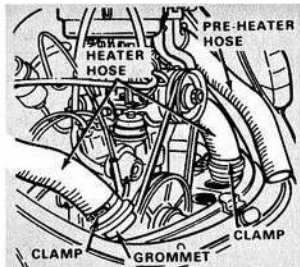

### CAUTION

Screws or small parts can be lost down heater hose openings. Tape wrapping plastic over them to guard against this.

- d. Remove 3 screws holding each preheater pipe protection plate on the sides of the engine.

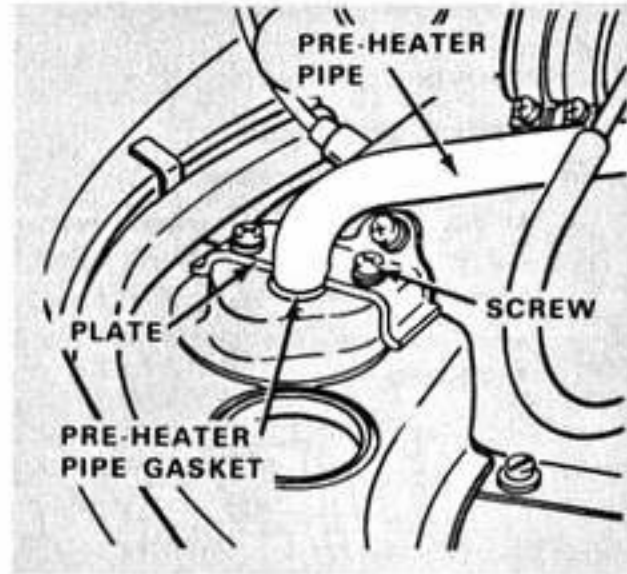

- e. Remove 3 sheetmetal screws holding the crankshaft pulley cover plate.

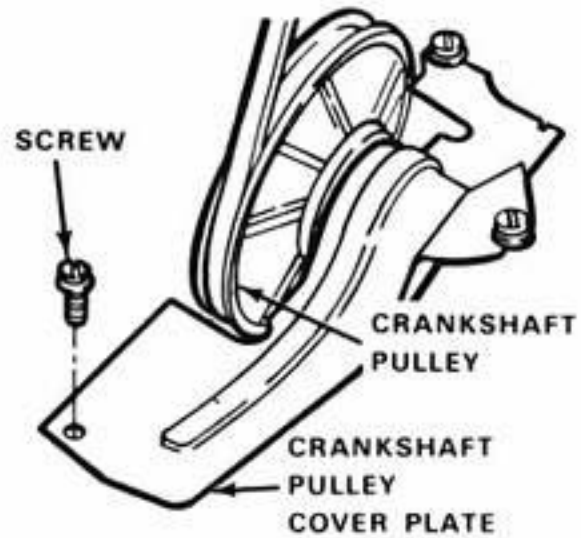

- f. Remove right, left, and center engine cover plate screws.
- g. Lift rear engine cover plate from engine compartment.

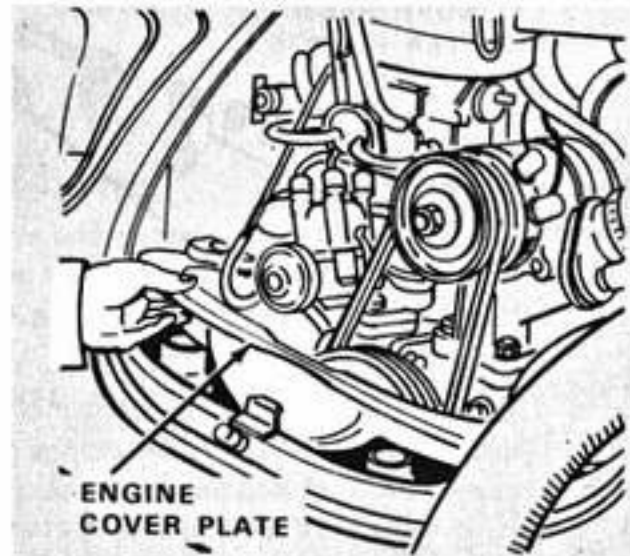



- h. Apply penetrating oil to the four 10 mm bolts attaching the intake manifold preheat pipes to the muffler adapters. (Right and left sides.) Allow oil to penetrate for a few minutes. Remove bolts when free.

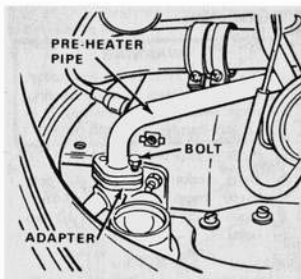

- i. Apply penetrating oil to the four 13 mm nuts holding the muffler flange to the cylinder head. (Both sides.) Remove the nuts when they are free.

**NOTE**

Removing the lower nut on the right side frees the carburetor pre-heating adapter.

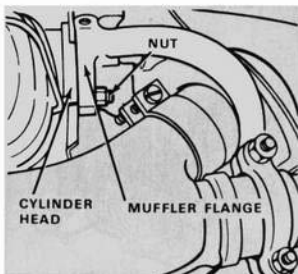

- j. Using the flat blade screwdriver loosen warm air channel clamps on each side.
- k. Using the 10 mm wrenches, remove the heat exchanger clamps on both sides.
- l. Lift muffler away. Remove gaskets from cylinder head flanges and pre-heat adapters.

**3. Inspection**

- a. Check muffler for holes caused by corrosion or damage.
- b. Check that round sealing surfaces are free of damage.

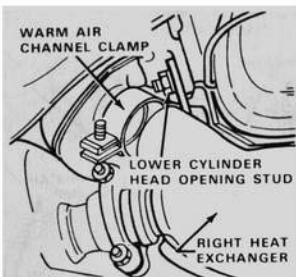

#### 4. Installation

##### WARNING

If old muffler is to be reinstalled, always use new gaskets, sealing rings, and fasteners contained in kit, VW Part No. 111 298 009.

- Place muffler in position.
- Place gaskets on manifold pre-heater pipe adapters. Attach pipes to the adapters with 10 mm bolts.

##### NOTE

It may be necessary to insert a drift pin through the holes to line them up.

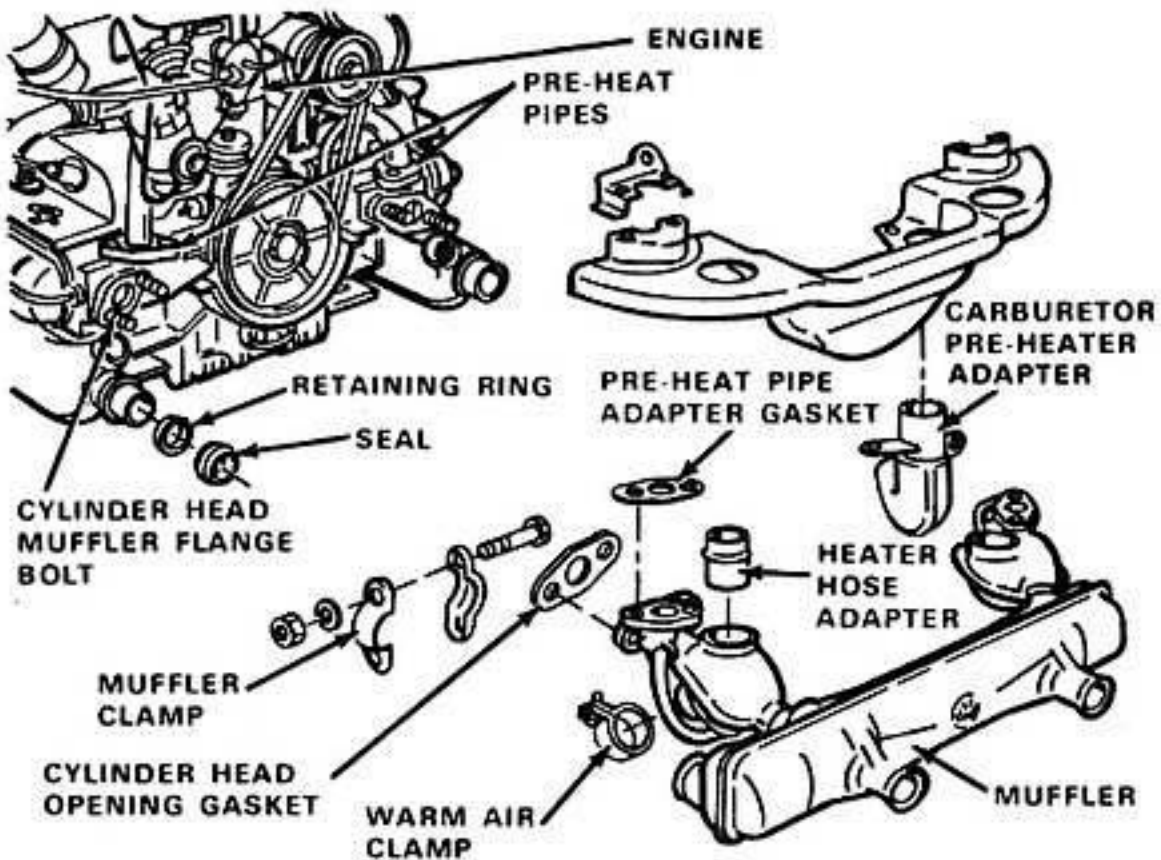
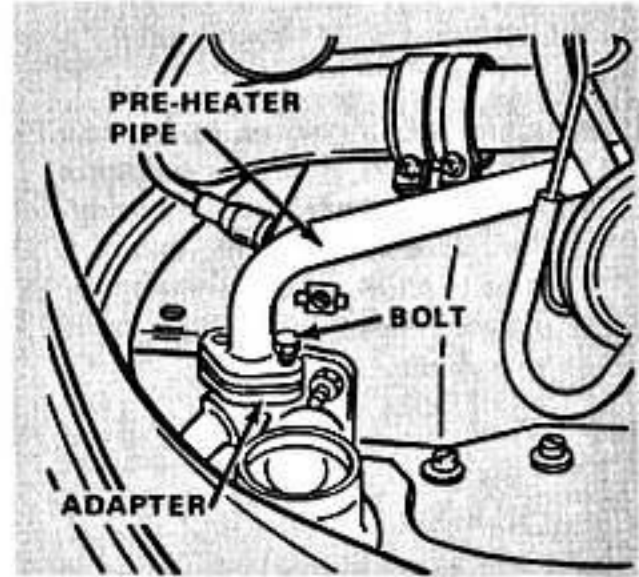

Place gaskets on the cylinder head openings. Fasten muffler in place with four 13 mm nuts. In securing the right side, be sure adapter for carburetor pre-heater is placed on lower stud after gasket and muffler.

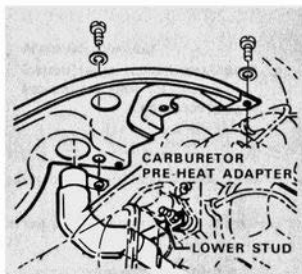
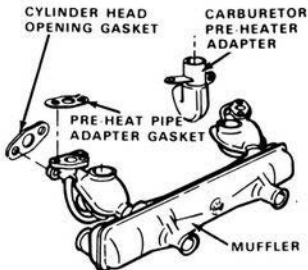

- d. Using the 10 mm socket wrench, install clamps between muffler and heat exchanger. Torque them to 7 foot pounds.
- e. Using the flat bladed screwdriver, tighten the warm air clamps.

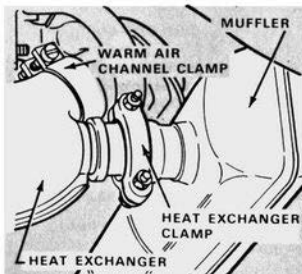

- f. Install rear engine cover plate. Be sure pre-heater pipe gaskets are in good condition.

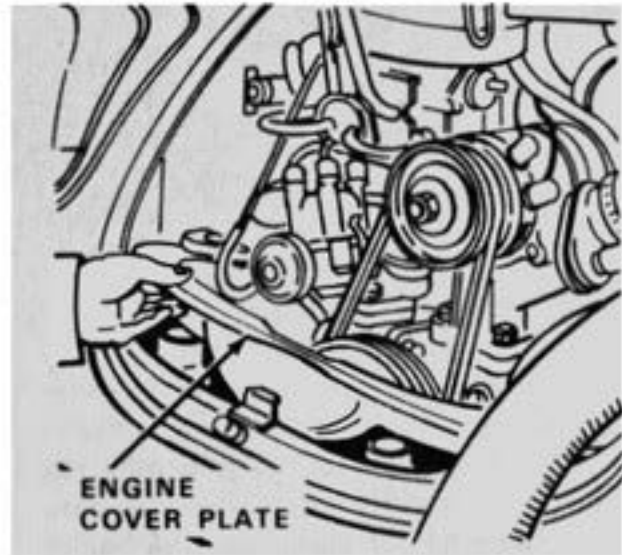

- g. Install pre-heater pipe protection plates. Be sure gaskets are in good condition.

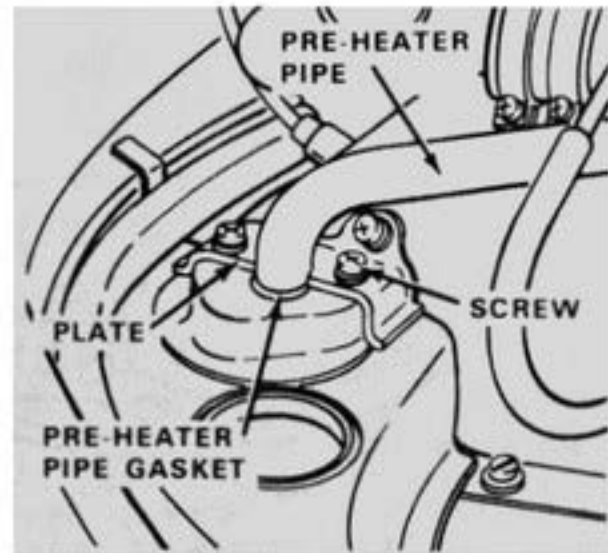

- h. Install crankshaft pulley cover plate with three screws.
- i. Insert heater hose adapters.

**NOTE**

Be sure to remove all coverings placed over openings earlier.

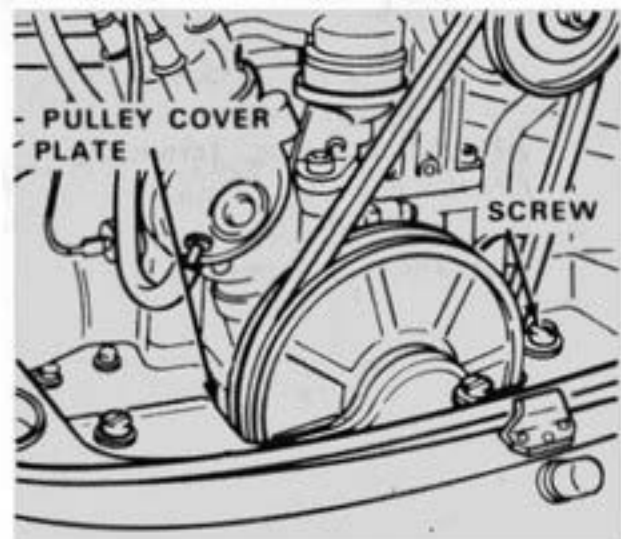

- j. Attach pre-heater and heater hoses. Tighten heater hose clamps.
- k. Close engine hood.
- l. Install or replace tail pipes as required. See Tail Pipes below.

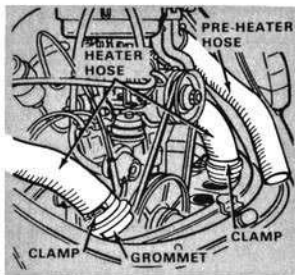

## Tail Pipes

### Tools Needed

Open end wrench, 10 mm  
 Box wrench, 10 mm  
 Socket wrench, 10 mm, 3/8 inch drive  
 Torque wrench, 0 to 150 foot-pounds,  
 3/8 inch drive

### Materials Needed

2 kits VW Part No. 111 298 051  
 Penetrating oil

Tail pipes are attacked by rust and corrosion both inside and outside. The damage is usually found in two areas:

- The welds holding the inner tube in the pipe rust away, allowing the liner to come out.
- The tubing itself rusts away, usually where it comes out of the muffler.

### 1. Removal

- a. Apply penetrating oil around the tail pipe.
- b. Using the 10 mm wrenches, remove the tail pipe clamps.
- c. Wiggle pipe while pulling it out. Remove pipe.

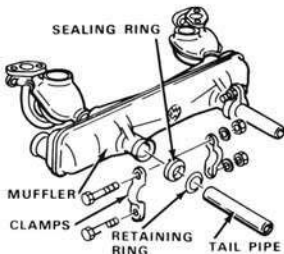

## 2. Installation

### NOTE

Tail pipes have a metal outer casing and perforated metal inner tube. The two parts are flush on the exhaust end. The inner tube is recessed on the muffler end.

- Mark a line  $3\frac{5}{8}$  inches from muffler end of tail pipe. This is to prevent tail pipe from being inserted too deeply.
- Slide the asbestos sealing ring over the muffler end until it has passed the line. Back it up to the line.
- Slide the metal retaining ring over the exhaust end of the tailpipe until it rests against the sealing ring.

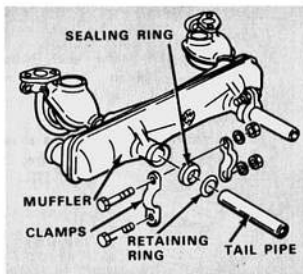

- Push new tailpipe into the muffler until the sealing ring rests in the muffler flange.
- Place clamp halves over retaining ring and muffler flange. Secure them with 10 mm bolts, nuts, and washers. Torque nuts to 7 foot pounds.

## Steering Damper (Beetle)

### Tools Needed

- Open end wrench, 17 mm
- 2 support stands
- Socket wrench, 17 mm,  $\frac{3}{8}$  inch drive
- Torque wrench, 0 to 150 foot pounds,  $\frac{3}{8}$  inch drive

### Materials Needed

- Lockplate VW Part No. 113 415 949
- Steering damper WV Part No. 113 425 021
- Locknut VW Part No. 131 405 323

The steering damper does not require maintenance and cannot be repaired. It should be occasionally checked to make sure it is not leaking. A damper that is wet with fluid should be removed and checked.

### NOTE

Small traces of fluid on the damper are acceptable.

## 1. Removing Steering Damper

- Drive car to a level surface.
- Break wheel bolts loose on right front wheel.

### WARNING

Follow the jacking procedures in Chapter 4, Jacking and Supporting, page 14. Do not work under the raised car until it is on support stands.

c. Raise the right side of the car and support it with support stands. Remove right front wheel. See Removing a Wheel, page 105.

d. Bend tabs of lockplate down. Using the 17 mm open end wrench, remove bolt from bracket on axle beam.

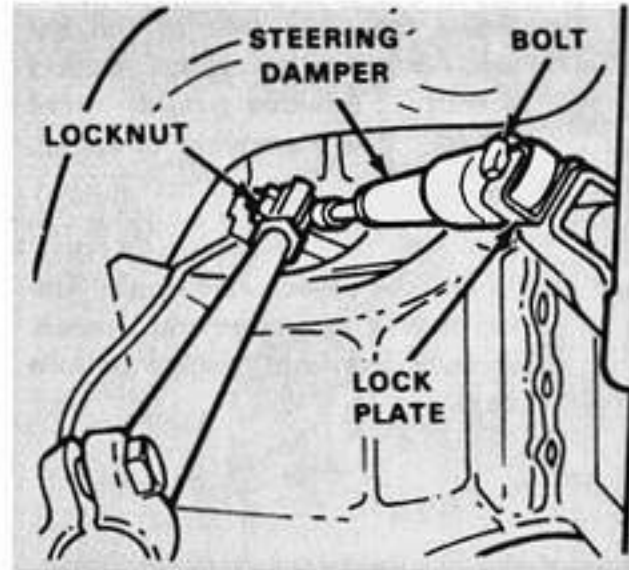

e. Remove nut at tie-rod eye. Push shaft of damper out of tie-rod eye.  
f. Remove steering damper and lockplate.

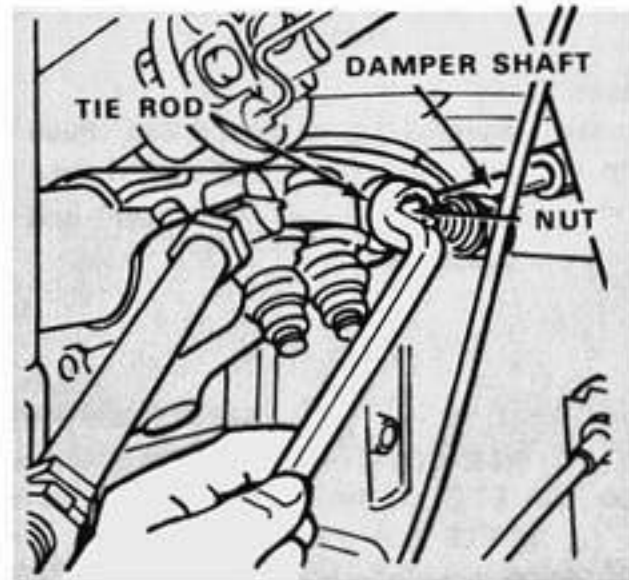

## 2. Checking Steering Damper

- Check damper by pulling out and pushing in the rod. The effort to move the rod must be equally firm and smooth over full distance traveled. The rod must not jerk when being pulled or pushed.
- Check rubber bushing and sleeve in damper for wear or damage. If worn or damaged, have them replaced or replace the damper.

### 3. Installing Steering Damper

#### NOTE

Always use a new lockplate and locknut.

- a. Place new lockplate over damper. Position damper on bracket on axle beam. Using the 17 mm open end wrench, start bolt into bracket.
- b. Position damper shaft in tie-rod eye. Using the 17 mm socket wrench and torque wrench, install locknut and tighten to 30 foot-pounds.
- c. Using the 17 mm socket wrench and torque wrench, tighten the bolt through the bracket on the axle beam to 30 foot-pounds.
- d. Bend tabs of the lockplate up and around flats of bolt head.

#### WARNING

Follow the jacking procedures in Chapter 4, Jacking and Supporting, page 14. Do not work under the raised car after removing support stands.

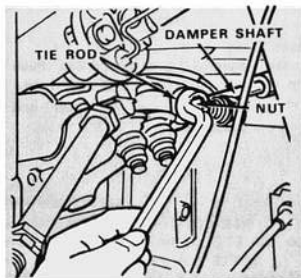
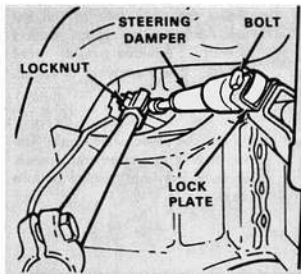

- e. Install wheel. See Installing a Wheel, page 106. Remove support stands. Lower car to ground.



## Steering Damper (Super Beetle)

### Tools Needed

Torque wrench, 0 to 150 foot-pounds,  
 $\frac{3}{8}$  inch drive  
Socket wrench, 15 mm,  $\frac{3}{8}$  inch drive  
Socket wrench, 17 mm,  $\frac{3}{8}$  inch drive  
Support stands (2 each)  
Clean cloth  
Screwdriver,  $\frac{3}{16}$  inch

### Materials Needed

Steering damper VW Part No.  
113 425 021 C

The steering damper does not require maintenance and it cannot be repaired. It should be occasionally checked to make sure it is not leaking. A damper that is wet with fluid should be removed and checked.

### NOTE

Small traces of fluid on the damper are acceptable.

### 1. Removing Steering Damper

- a. Drive car to a level surface.
- b. Open luggage compartment and remove spare tire cover. Unscrew hose for windshield washer from spare tire. Remove spare tire.

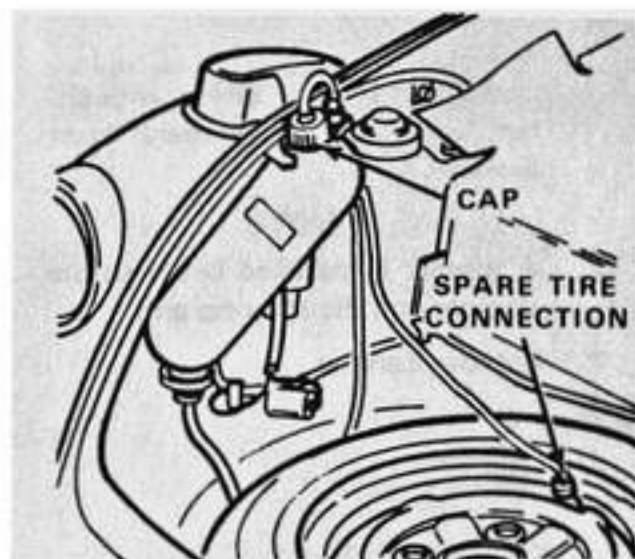

- c. Remove access cover for steering damper by prying. Use a cloth to protect paint when prying cover off with screwdriver.

### NOTE

It may be necessary to push the cover out with a screwdriver from under the car.

- d. Using the 15 mm socket wrench, remove bolt and washer from threaded adapter.

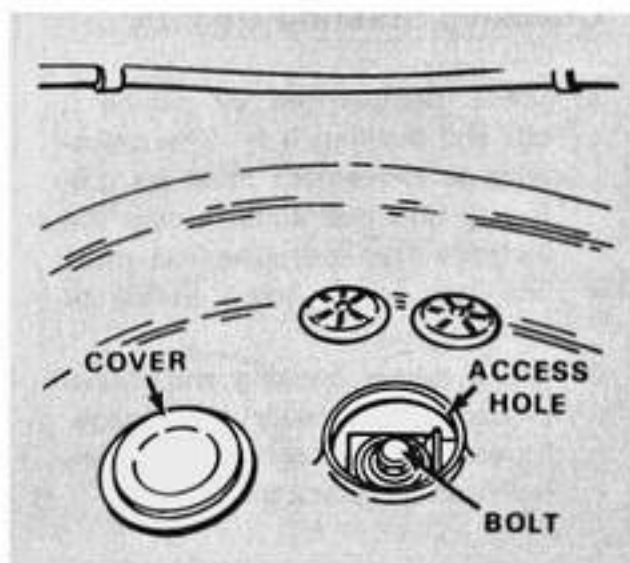

- e. Break wheel bolts loose on left front wheel.

**WARNING**

Follow the jacking procedures in Chapter 4, Jacking and Supporting, page 14. Do not work under the raised car until it is on support stands.

- f. Jack the car and support it with support stands. Remove the left front wheel. See Removing a Wheel, page 105.

- g. Using the 17 mm socket wrench, remove bolt and washers from arm eye.

**NOTE**

A washer is installed between the damper and the steering arm.

- h. Remove damper.

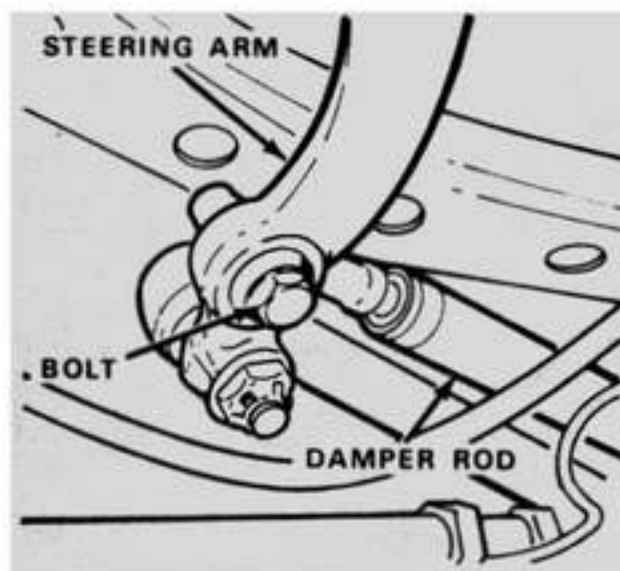
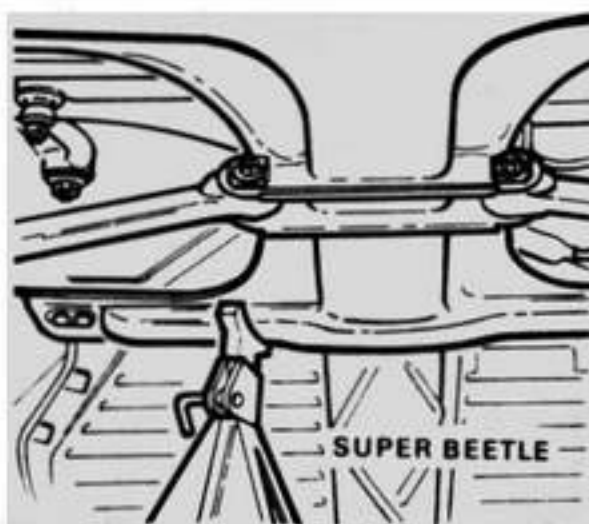

## 2. Checking Steering Damper

- a. Check damper rod by pulling it out and pushing it in. The resistance to movement must be uniformly firm and smooth over the distance traveled. The rod must not jerk when being pulled or pushed.
- b. Check rubber bushing and sleeve in damper for wear or damage. If worn or damaged have them replaced or replace the damper.

### 3. Installing Steering Damper

- a. Place a washer on top of the steering arm eye. Place damper on top of washer.
- b. Install bolt and washer through the eye and thread bolt into the damper. Make sure washer between damper and the steering arm eye remains in place.
- c. Position damper on threaded adapter.

#### NOTE

It may be necessary to pull the damper rod out or push it in to line up the bolt holes.

- d. Place washer on bolt. Working from inside the luggage compartment, thread bolt through damper into adapter. Using the 13 mm socket wrench and the torque wrench, torque the bolt in the threaded adapter to 29 foot-pounds.
- e. Using the 17 mm socket wrench and the torque wrench, torque the bolt at the steering arm to 18 foot-pounds.
- f. Install wheel. See Installing a Wheel, page 106.

#### WARNING

Follow the jacking procedures in Chapter 4, Jacking and Supporting, page 14. Do not work under the raised car after removing support stands.

- g. Raise the car off the stands. Remove stands and lower car.
- h. Place access cover over hole in luggage compartment. Tap cover around edge with screwdriver handle to seat it in access hole.

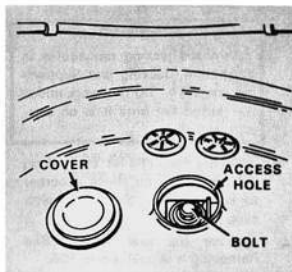
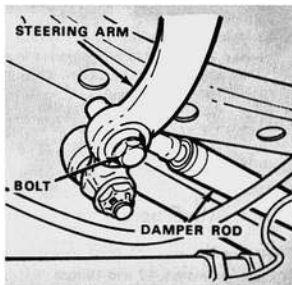

- i. Place spare tire in compartment with air valve on side near windshield washer container. Screw hose for windshield washer on spare tire air valve.
- j. Install spare tire cover. Make sure washer hose is positioned in slot in cover near container. Close luggage compartment.

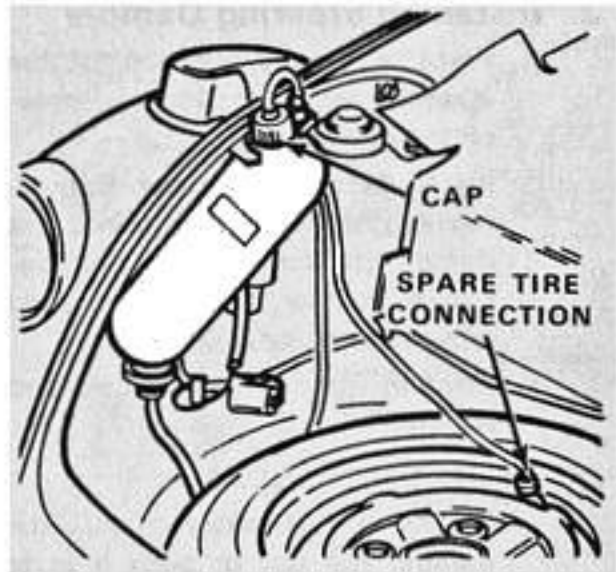

## Shock Absorbers

### Tools Needed

Open end wrenches, 17 and 19 mm  
 Box wrench, 19 mm  
 2 support stands

### Materials Needed

Shock absorber, VW Part No.  
 113 513 031 N

The shock absorbers do not require maintenance and cannot be repaired. They should be occasionally checked to make sure they are not leaking. Small traces of fluid are acceptable if the shock absorber still works well, you do not need to replace it. If the shock absorber does not work properly or if it has lost a large amount of fluid, it should be replaced.

Replacing front shock absorbers requires special equipment. It is a job for your dealer, who has the equipment and know-how that are needed. Only the rear shock absorbers are covered in this procedure.

### 1. Removing Rear Shock Absorber

#### WARNING

Follow the jacking procedures in Chapter 4, Jacking and Supporting, page 14. Do not work under the jacked car until it is on support stands.

- a. Jack the rear end of the car on the side with the shock absorber to be removed. Support it with support stands.
- b. Remove the rear wheel. See Removing a Wheel, page 105.

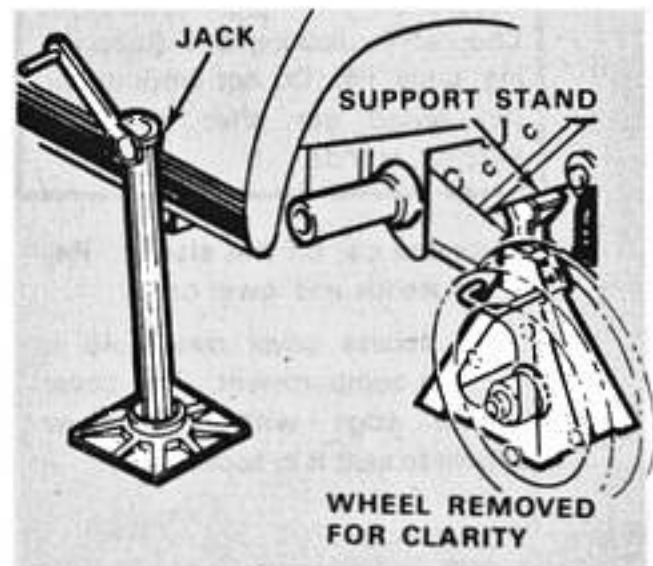

- c. Remove nut and washer from lower end of shock absorber. Pull bolt out of shock absorber.
- d. Remove nut and washer from bolt in upper end of shock absorber.
- e. Lift shock absorber out of lower support and remove it.

## 2. Checking Rear Shock Absorber

- a. Check shock absorber by pulling rod out and pushing it in.
- b. Check rod movement. It should be smooth and require equal effort over full distance traveled.

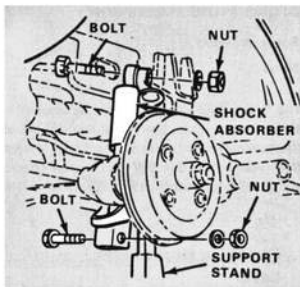

## 3. Installing Rear Shock Absorber

- a. Place lower end of shock absorber in support. Line up holes in support with shock absorber. Install bolt, washer, and nut. Tighten nut.
- b. Extend shock absorber until upper end is in line with hole in support.
- c. Install bolt through shock absorber and support. Place washer and nut on bolt. Tighten nut.
- d. Install the rear wheel. See Installing a Wheel, page 106.

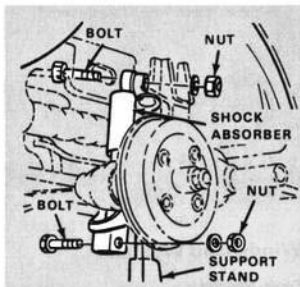

### WARNING

Follow the jacking procedures in Chapter 4, Jacking and Supporting, page 14. Do not work under the jacked car after removing support stands.

- e. Jack car off support stands. Remove stands and lower the car.

## Brake Fluid Reservoir

### *Tools Needed*

None

### *Materials Needed*

None

The brake fluid should always be above the edge near the top of the reservoir. If the level is below the edge, the brake system should be checked. A low level may mean a leak in the brake system, wear of the brake linings or some other fault. Do not try to fill the brake fluid yourself. Your VW dealer can check your complete brake system and repair it. He will also fill the reservoir with the fluid of the proper specification and quality.

### 1. Checking Brake Fluid Level

- a. Open luggage compartment.
- b. Check that brake fluid level is above edge on reservoir. If fluid level is low, have your local VW dealer check your brake system.

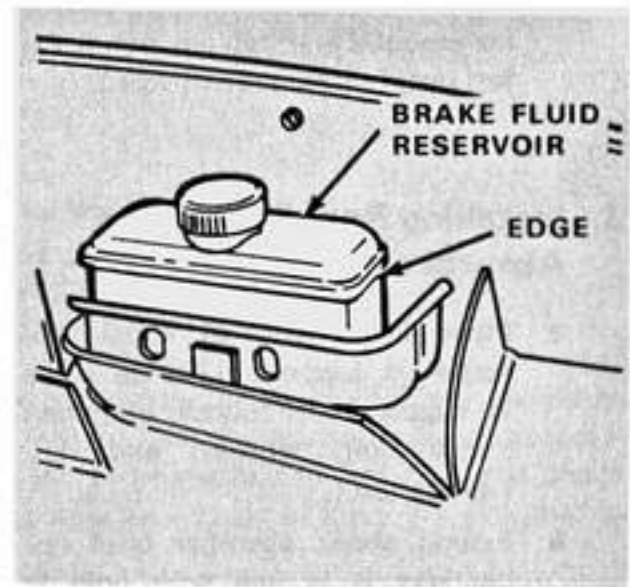

## Windshield Washer

### *Tools Needed*

None

### *Materials Needed*

Windshield washer Anti-Freeze and Solvent, VW Part No. ZVN 241 101 or equivalent

The windshield washer container is in the luggage compartment. Air pressure from the spare tire is used to operate the windshield washer. Every time you stop for gas, you should have the air pressure in the spare tire checked. The air pressure should be 43 psi.

## 1. Filling Windshield Washer

- a. Remove the cap from the windshield washer container. Fill the container with water and a cleaning solution.
- b. During the winter, fill the container  $\frac{3}{4}$  full. This will leave room for expansion if the solution freezes.
- c. If you use an anti-freeze solution, be sure you use the right mixture of anti-freeze and water. The correct mixture will be printed on the anti-freeze container.

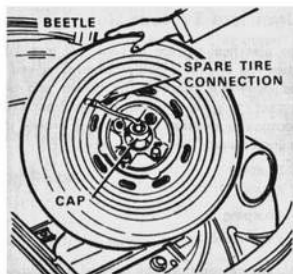
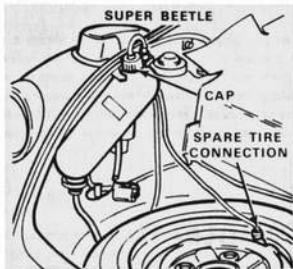

# Chapter 6

## General Service

### Electrical System

The electrical system in your VW is a 12 volt system. The battery supplies the power when the engine is below a certain speed. When the engine is running above this speed, the generator supplies the power and recharges the battery. Fuses in certain circuits protect the generator and battery from overloads caused by damages to the system. The electrical system as presented is broken down into the smaller circuits to make it easier to understand. The circuits are:

- Starting
- Ignition
- Charging
- Interior Lights
- Exterior Lights
- Instruments
- Automatic Stick Shift

Located on the front left side of the engine compartment is an electrical receptacle. This receptacle is used in manufacturing and diagnosis. It cannot be used without special diagnosis equipment. The cover on the receptacle should always be closed. Do not tamper with this receptacle.

### Charging Circuit

When the engine is not running, the battery supplies the power to the system. As engine speed increases, the generator starts to produce voltage. When the voltage is large enough, it causes a relay in the regulator to connect generator output to the system and the battery. If the generator output decreases past a set voltage, the regulator will disconnect the generator from the system and prevent the battery from discharging through the generator. A generator warning light is installed in the instrument panel. This light indicates when the battery is supplying power to the system. Power to one side of the light is supplied by the battery through the ignition switch. When the engine is running below generator cutout speed, the light is lit. When generator output is large enough, it applies power to other side of the light and the light will go out.



## **Starter Circuit**

Electrical power is supplied from the battery to a terminal of the starter solenoid and to a terminal on the ignition switch. When the ignition switch is turned, power is applied to the coil of the solenoid. This power causes the solenoid to move the gear on the starter into contact with the flywheel. As the solenoid moves it closes a switch which applies power to run the starter. After the engine starts and the ignition switch is released, power is removed from the solenoid and it returns to normal. A spring in the starter gear moves the gear back out of contact with the flywheel.

## **Ignition Circuit**

With the ignition switch on, battery or generator output is supplied through the switch to the primary of the coil, automatic choke, and pilot jet. Voltage is applied direct to the choke and pilot jet to regulate fuel flow. The ground circuit of the coil is through the distributor points. As the distributor shaft rotates, it opens and closes the point to make and break the circuit to ground. When the points are closed, power flows through the primary winding of the coil producing a force in the secondary of the coil. When the points open, the force in the secondary collapses, creating a high voltage output. This output is applied to the rotor of the distributor as the rotor comes in line with a contact in the distributor cap. The contact passes the power to a spark plug. This high voltage causes the current to arc across the gap between the spark plug elements and ignites the fuel mixture in the cylinder. This takes place four times in one rotation of the distributor shaft, with the power being directed to each plug in proper sequence.

## **Interior Lights and Ignition Key Warning Buzzer**

### **Interior Light**

The interior light contains a three position switch. With the switch in the center position the light will not light. Moving the switch to the upper position turns the light on regardless of the door contact switch. Moving the switch to the bottom position sets the light up for operating with the door contact switch. With the doors closed the ground circuit for the light is open and the light is out. Opening either door connects the light through the door contact switch to ground and lights the light. The circuit is protected by a fuse in the fuse box.

### **Instrument Panel Light**

The two lights on the instrument panel are controlled by the light switch. Pulling the switch out connects power to the lights. Turning the switch controls the brightness of the lights.

### **Ignition Key Warning Buzzer**

Once ignition has been turned on, opening the left side door without removing the key will energize the ignition warning buzzer. The buzzer sounds even if the ignition system has been turned off. Buzzing will continue until the door is closed or the key removed from the ignition. The warning buzzer is protected by a fuse in the fuse box.

## Exterior Lights

Exterior lights fall into two categories:

- Lights Independent of the Ignition Switch
- Lights Which Work Only With the Ignition Switch On

### 1. Lights Independent of the Ignition System

#### a. Park, Side, and License Plate Lights

Pulling the light switch knob out to the first stop supplies power to the front and rear park lights, front side lights, and license plate light. All park lights contain dual element bulbs. The forward element in the front park bulbs and the right-hand element in the rear park bulbs light when the switch is pulled.

The front park and side lights, the rear park lights, and the license plate light are protected by fuses in the fuse box.

The park and side lights remain on when the light switch is pulled all the way out.

#### b. Emergency Flasher System

Pulling the emergency flasher switch out causes the rear elements in the two front parking lights and the two upper bulbs in the rear fender fixtures to flash on and off continuously and simultaneously. The control knob and the green arrow indicator in the speedometer also flash to indicate the system is energized. Flashing continues as long as the switch is pulled out regardless of whether the car is parked or being driven.

### 2. Lights Dependent on the Ignition Switch

#### a. Turn Indicator Lights

With the ignition switch on, pushing the turn signal lever up causes the rear elements in the right-hand front park light and the upper bulb in the right rear fender fixture to flash on and off continuously and simultaneously. Pushing the lever down causes the left-hand lights to flash. Flashing stops when the lever is centered. A green arrow indicator in the speedometer flashes to indicate the system is energized.

The turn indicator system is protected by a fuse in the fuse box.

#### b. Brake Lights

Depressing the brake pedal with the ignition switch on closes dual pressure switches completing circuitry to the left-hand elements of the center bulbs in the rear fender fixtures. The lights remain lighted until the pedal is released. A dash mounted warning light illuminates if either or both pressure switches fails. The warning light bulb lights when the ignition key is turned before the engine starts. The brake light circuitry is protected by a fuse in the fuse box.

### **c. Head Lights**

With the ignition switch on, pulling the light switch knob all the way out supplies power to the headlights as well as to the Park, Side and License Plate Lights. The headlights are switched from high to low beam and back by pulling back on the turn signal and headlight dimmer switch. Switching to high beam illuminates the high beam warning light in the speedometer. The headlights are protected by four fuses in the fuse box.

### **d. Backup Lights**

When backing the car, placing the gear shift in reverse closes the backup light switch illuminating the backup lights. The backup light circuit is protected by an inline fuse.

## **Instruments**

### **Fuel Gauge**

The fuel gauge is a thermo-electrical indicator located in the speedometer. It indicates the amount of fuel available by a needle moving across a scale. The needle is moved in one direction by a spring and in the other by the heating and bending of a bimetal strip. The bimetal strip is heated by current flow through a coil wrapped around it. Current is provided by a vibrator and controlled by the variable resistor in the fuel gauge sending unit in the tank. The fuel gauge system is protected by a fuse in the fuse box.

### **Oil Pressure Warning Light**

A red oil pressure warning light is also located in the speedometer. It illuminates when the ignition switch is turned on and stays lit until the engine has started and oil pressure is built up. Sufficient pressure displaces a diaphragm in the switch and turns the light off. The light will come on any time the ignition switch is on and the oil pressure drops. The oil pressure light is protected by a fuse in the fuse box.

### **Horn**

The horn is a single tone signal. It is operated by the horn button on the steering wheel. Pressing the button sends current to a breaker mechanism within the horn which vibrates a diaphragm to produce sound. The horn system is protected by a fuse in the fuse box. Horn will not blow with the ignition switch off.

### **Windshield Wiper**

The windshield wipers are driven by a single electric motor. Moving the wiper switch lever to the first stop produces a single slow wiping sweep unless the lever is held in position. When the lever is released it centers and the wipers park. When the wiper switch lever is moved to the second position, the wipers continue to sweep slowly until the lever is moved to turn them off. In the third position the wipers sweep rapidly until the lever is moved to turn them off. In each mode the blades park automatically. The wipers will not operate unless the ignition switch is on. The system is protected by a fuse in the fuse box.

#### **Rear Window Defogger (Super Beetle only)**

The rear window defogger is activated by turning the control switch on when the ignition switch is on. This closes a relay and supplies current to the window elements. A warning light in the speedometer comes on simultaneously to remind the driver that the circuit is energized. The rear window defogger system is protected by a fuse in the fuse box and an inline fuse.

#### **Fan Motor (Standard on Super Beetle)**

The fresh air fan consists of a two speed unit which blows outside air into the car. Turning the switch to the first stop yields slow motor operation and slight airflow. Turning it to the second increases motor speed and airflow.

#### **Automatic Stick Shift (Super Beetle only)**

The Automatic Stick Shift contains a control valve, selector lever contact, and a starter cut-out switch. Also installed is an automatic transmission fluid temperature circuit. The temperature circuit has an indicator in the speedometer and a control switch which connects the indicator to ground when the fluid is too hot. The indicator is protected by a fuse in the fuse box.

The Automatic Stick Shift circuit has a fuse between the coil and the control valve. With the selector lever and the control valve in any position but neutral, a starter cut-out switch opens the circuit to the starter. This prevents starting the car with the transmission engaged. The circuit is protected by an inline fuse.

#### **WARNING**

Whenever you are working on the electrical system of your car, make sure you disconnect the battery and remove all jewelry, especially rings. Although the electrical system works on 12 volts, in some cases an electrical shock could injure you.

## Wiring Diagram

This diagram is presented in two sheets for easier use. Some components are shown on both since they are used in more than one circuit.

***Circuits shown on this sheet are:***

- Ignition
- Generator
- Starter
- Instruments
- Indicators
- Windshield wiper
- Interior Lights
- Horn
- Backup and Brake Lights

### PART CODE

- F1 — Back-up Light In-line Fuse  
 F2 — Fuse For Rear Window Defogger  
 F3 — Fuse For Automatic Stick Shift Control Valve  
 G1 — Fuel Gauge  
 G2 — Fuel Gauge Vibrator  
 H — Horn Button  
 L1 — ATF Temperature Warning Light  
 L2 — High Beam Warning Light  
 L3 — Oil Pressure Warning Light  
 L4 — Turn Signal Warning Light  
 L5 — Generator Charging Warning Light  
 L6 — Rear Window Defogger Warning Light  
 L7 — Instrument Panel Light  
 ○ — Diagnostic Plug Connection

### CONNECTOR CODE

- T — Cable Adapter  
 T<sub>1</sub> — Cable Connector, Single  
 T<sub>2</sub> — Cable Connector, Double  
 T<sub>3</sub> — Cable Connector, Triple  
 T<sub>4</sub> — Cable Connector, Quadruple

### COLOR CODE

- B — Black  
 Bl — Blue  
 Br — Brown  
 G — Gray  
 Gn — Green  
 R — Red  
 W — White  
 Y — Yellow  
 B/G — Black/Gray  
 B/Gn — Black/Green  
 B/Gn/W — Black/Green/White  
 Bl/Gn — Blue/Green  
 B/P — Black/Purple  
 B/W — Black/White  
 Bl/W — Blue/White  
 B/Y — Black/Yellow  
 Br/W — Brown/White  
 Br/Bl — Brown/Blue  
 G/Bl — Gray/Blue  
 R/B — Red/Black  
 R/G — Red/Gray  
 R/Bl — Red/Blue

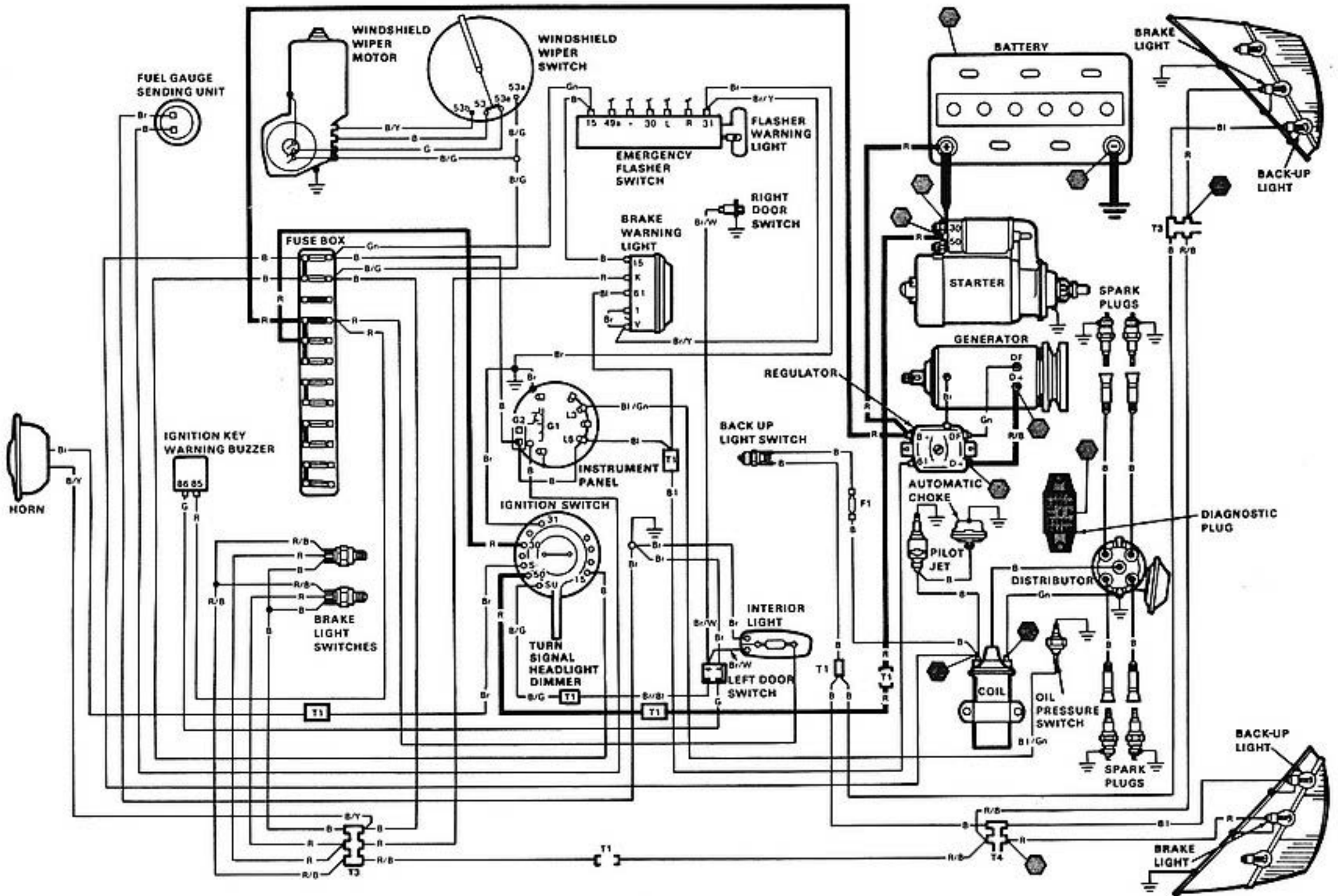

## Wiring Diagram

This diagram is presented in two sheets for easier use. Some components are shown on both since they are used in more than one circuit.

***Circuits shown on this sheet are:***

- Headlights
- Taillights
- Turn Signals
- Parking Lights
- License Plate Light
- Rear Window Defogger
- Automatic Stick Shift
- Emergency Flasher

PART CODE
F1 — Back-up Light In-line Fuse
F2 — Fuse For Rear Window Defogger
F3 — Fuse For Automatic Stick Shift Control Valve
G1 — Fuel Gauge
G2 — Fuel Gauge Vibrator
L1 — ATF Temperature Warning Light
L2 — High Beam Warning Light
L3 — Oil Pressure Warning Light
L4 — Turn Signal Warning Light
L5 — Generator Charging Warning Light
L6 — Rear Window Defogger Warning Light
L7 — Instrument Panel Light — Diagnostic Plug Connection

### CONNECTOR CODE

T — Cable Adapter
T <sub>1</sub> — Cable Connector, Single
T <sup>2</sup> — Cable Connector, Double
T <sup>3</sup> — Cable Connector, Triple
T <sup>4</sup> — Cable Connector, Quadruple

COLOR CODE
B — Black
Bl — Blue
Br — Brown
G — Gray
Gn — Green
R — Red
W — White
Y — Yellow
B/G — Black/Gray
B/Gn — Black/Green
B/Gn/W — Black/Green/White
B/P — Black/Purple
B/W — Black/White
Bl/W — Blue/White
B/Y — Black/Yellow
Br/W — Brown/White
Br/Bl — Brown/Blue
G/Bl — Gray/Blue
R/B — Red/Black
R/G — Red/Gray
R/Bl — Red/Blue

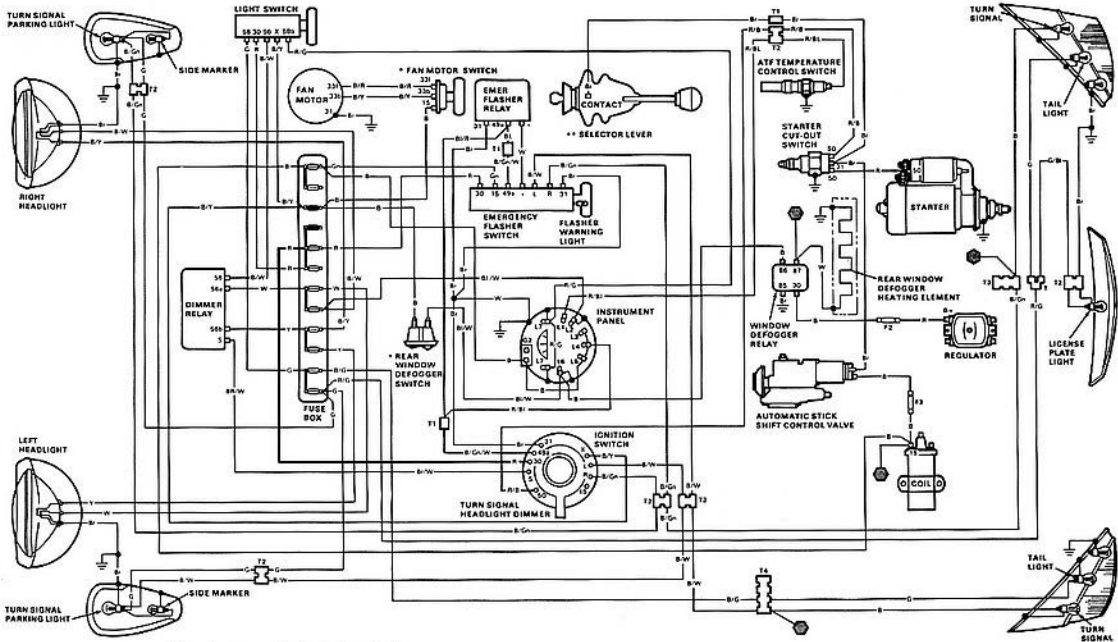

\* These items are standard on The Super Beetle.

\*\* This item is optional on the Super Beetle.



## Bulb Replacement

### **Tools Needed**

Phillips screwdriver No. 1 (magnetic tip)  
Phillips screwdriver No. 2  
Screwdriver, flat blade  $\frac{3}{16}$  inch  
Paper cup for parts  
Typewriter eraser (pencil type)

### **Materials Needed**

Bulbs (See chart for Part No.)  
Silicone spray

### **NOTE**

If either the bulb or the contacts in the socket are corroded or dirty, the bulb might not work. To remove dirt or corrosion, rub the area with a typewriter eraser (pencil type) until the area is clean and shiny. Be careful that you do not bend the contacts. Before installing a bulb make sure that all dirt or corrosion is removed. Spray gaskets and weatherstrips with silicone to ease installation.

## Bulb Replacement Chart

<b>Bulb</b>	<b>Replacement Bulb</b>	<b>VW Part No.</b>
Sealed beam (headlight)	6012	ZVP 118 112
Front turn signals and parking lights	1034	ZVP 118 034
Rear turn signal lights	1073	ZVP 118 073
Side marker lights	57	ZVP 118 057
Stop and tail lights	1034	ZVP 118 034
Back-up lights	1073	ZVP 118 073
License plate light	89	ZVP 118 089
Instrument and warning lights	—	N 17 722 2
Warning lights for emergency flasher, brake operation, rear window defogger, Automatic Stick Shift, and Auxiliary Heater	—	N 17 751 2
Interior light: Sedan	211	N 17 723 2
Convertible	—	N 17 725 2

## Headlights

The headlights on your Volkswagen are double filament (high and low beam) sealed beam units.

The headlights do not need adjustment after replacement unless the adjustment screws have been changed.

### 1. Removing Headlights

- a. Using the No. 2 Phillips screwdriver, loosen the screw in the trim ring.

#### NOTE

The screw in the trim ring is not removable.

- b. Holding the screw, pull the trim ring off.
- c. Using the No. 1 Phillips screwdriver, remove the 3 screws in the retaining ring. Hold the headlight in place while removing screws. Remove the ring. Do not touch the long adjusting screw.

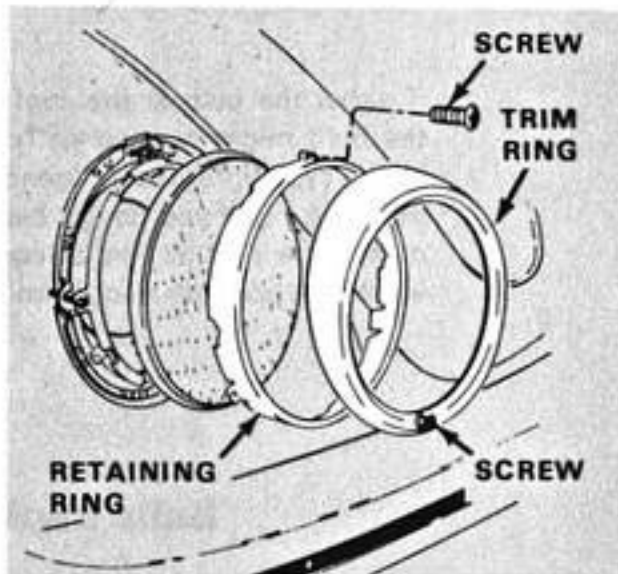

- d. Take headlight out of support ring. Hold headlight and pull cable connector off headlight by wiggling the connector. Do not pull on wires.

### 2. Installing Headlights

- a. Plug cable connector on headlight.
- b. Position headlight in support ring. Make sure the 3 lugs on the headlight are in the cutouts in the support ring.

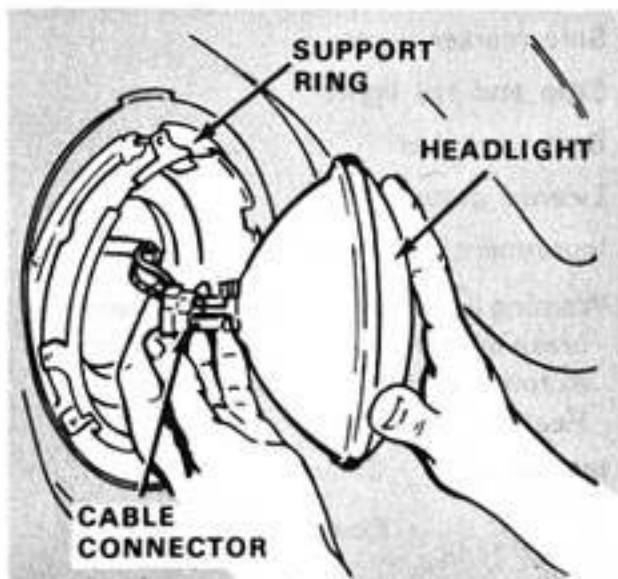

- c. Place the retaining ring in place over the headlight. Turn the ring until all 3 holes are in line with the holes in the support ring.
- d. Install the 3 screws in the retaining ring. Tighten the screws evenly.
- f. Before installing the trim ring, make sure the rubber gasket on the fender is intact.
- g. Loosely install the screw in the trim ring (2 or 3 turns) into the fender. Position edge of trim ring over lug on fender. Press ring over lug and tighten screw.
- h. Check adjustment of the headlight. See Adjusting Headlight, page 92.

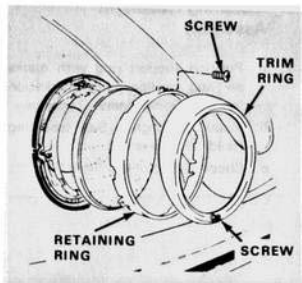

## Headlight Assembly

### Tools Needed

- Phillips screwdriver, No. 1 (magnetic tip)
- Phillips screwdriver, No. 2

### Materials Needed

- Chalk or grease pencil

### 1. Removing Headlight Assembly

- a. Remove headlight. See Removing Headlight, page 90.
- b. Using chalk or grease pencil, mark remaining 3 screw holes on the support ring and fender housing. Remove 3 screws and remove support ring.

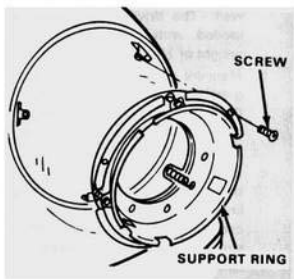

## 2. Installing Headlight Assembly

- Position support ring with marks on ring in line with marks on fender housing. Install 3 screws.
- Install headlight. See Installing Headlight, page 90.
- Check setting of headlight.

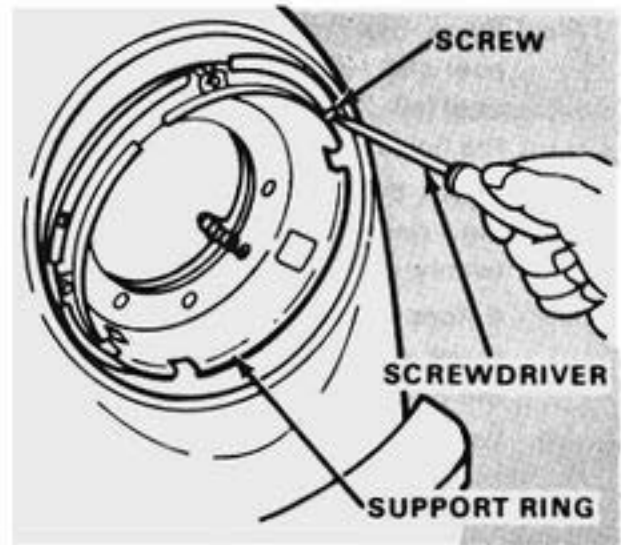

## 3. Adjusting Headlights

### Tools Needed

Aiming device (if available)  
Phillips screwdriver, No. 2  
Measuring tape

### Materials Needed

Chalk (if aiming device is not available)

### NOTE

It is best to check the headlight adjustment with an aiming device. Check with your State Bureau of Motor Vehicles for variation from the specifications in this procedure.

- Check tire pressure and adjust if necessary. See sticker inside glove compartment. Park car on level surface squarely facing a wall. The car should be 25 feet from the wall. The driver's seat must be loaded with one person or a weight of 154 pounds.
- Measure the height (a) from ground to center of headlights. Draw a line (H) on wall at this height. The line must be as long as the width of the car.
- Measure the distance (b) between the headlights. Draw a vertical line (V) on the wall opposite the center of each headlight. Make sure the distance between the lines is the distance (b).

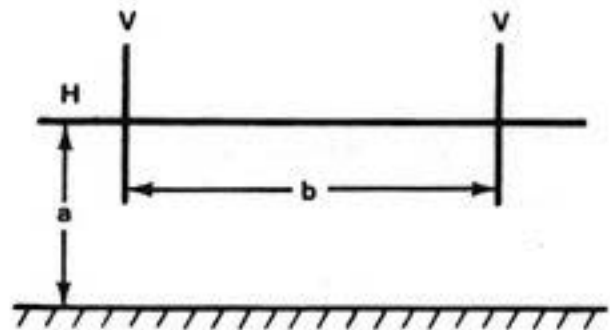

- Loosen the screw on the bottom of trim ring. Pull the ring off by pulling on the screw.

- e. Cover one headlight. Turn on the low beams. Check that the high intensity zone of the headlight is on line H and 2 inches right of line V.

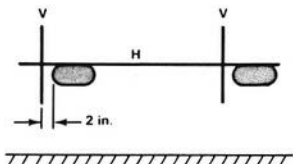

- f. If headlight needs adjustment, turn 2 adjusting screws.
- g. Remove cover from headlight. Install it on headlight that is adjusted. Check and adjust headlight as described in steps d. thru f.
- h. Remove cover from headlight. Loosely install screw in trim ring (2 or 3 turns) into fender. Position edge of trim ring over lug on fender. Press ring over lug and tighten screw.

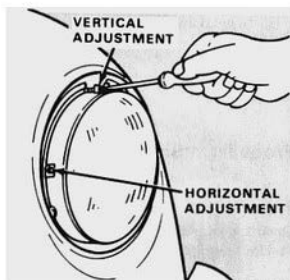

## Front Turn Signal/Parking Light or Side Marker Light Bulbs

### **Tools Needed**

Phillips screwdriver, No. 2

### **Materials Needed**

See bulb chart, page 89.

## 1. Replacing Bulb

- Using screwdriver, loosen 2 screws in housing. Lift off housing and lens together. If rubber grommets come off screws, hold them for installation.
- Press bulb lightly into socket and turn to left. Lift bulb out.
- Press new bulb lightly into socket and turn it to right.
- Make sure gasket is positioned correctly. Make sure rubber grommets are on screws. Place housing and lens over gasket. Position housing and lens so that gasket is over bottom edge of housing and gasket.

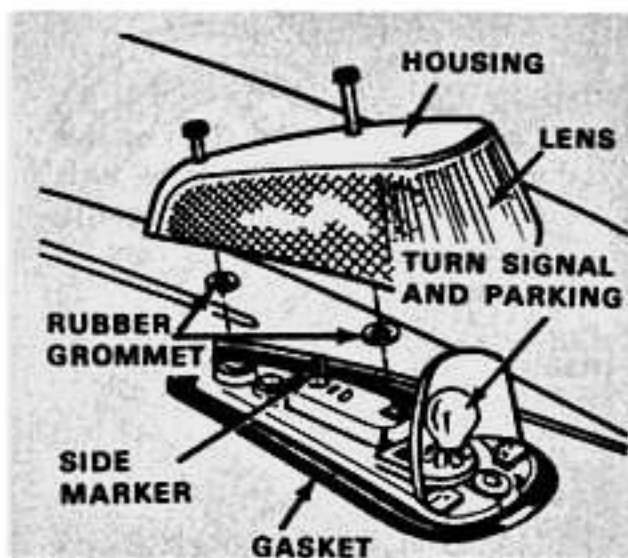

- Install 2 screws. Do not over-tighten.
- Check that the bulb works.

## Front Turn Signal and Parking Light Assembly

### *Tools Needed*

Open end wrench, 8 mm  
Phillips screwdriver, No. 2

### *Materials Needed*

None

## 1. Removing Assembly

- Using the screwdriver, loosen screws. Remove housing and lens together. If rubber grommets come off screws, hold them for installation.
- Using the 8 mm open end wrench, remove 2 nuts securing the bulb holder under the fender.
- Lift bulb holder from gasket. Disconnect wires by pulling connectors from bulb holder.

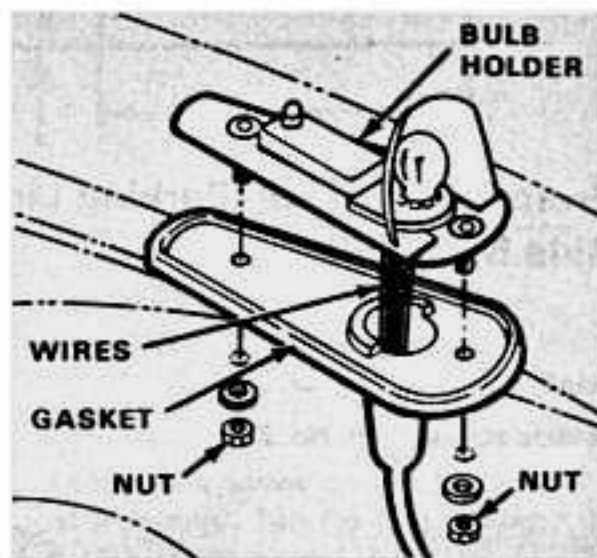

## 2. Installing Assembly

- a. Connect wires to bulb holder by pushing connector on terminals on holder as follows:  
Front bulb — right — brown wire  
              — center — black wire  
              — left — gray and small black wire  
Rear bulb — small black wire from front bulb

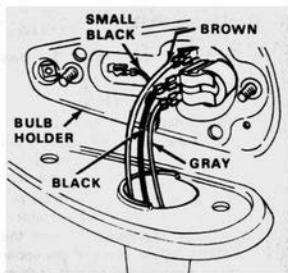

- b. Position holder in gasket. Screw 2 nuts and washers on studs under fender. Using 8 mm open end wrench, tighten nuts.
- c. Make sure rubber grommets are on screws through lens. Position lens and housing on bulb holder. Make sure gasket is positioned properly. Tighten screws. Do not overtighten them.
- d. Check that bulbs work.

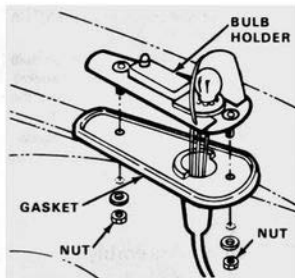

## Rear Turn Signal, Stop and Tail Light, or Back-up Light Bulbs

### **Tools Needed**

Phillips screwdriver, No. 2

### **Materials Needed**

See bulb chart, page 89.

## 1. Replacing Bulb

- Using screwdriver loosen 3 screws and remove lens.

### NOTE

The top bulb is for the turn signal. The center bulb is for stop and tail light. The bottom bulb is for the back-up light. The top and bottom bulbs are single filament and the center bulb is a double filament bulb. In an emergency, use the bottom bulb in place of the upper bulb. Replace the bottom bulb as soon as possible.

- Press the bulb lightly into the socket and turn it to the left. Lift the bulb out.
- Position bulb so that lugs on bulb are in line with slots in socket. Press a new bulb lightly into the socket and turn it to the right.
- Place the lens on the fender. Tighten 3 screws evenly. Do not overtighten the screws.

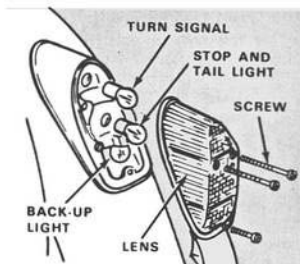

## Tail Light Assembly

### Tools Needed

Phillips screwdriver, No. 2  
Open end wrench, 8 mm

### Materials Needed

None

## 1. Removing Assembly

- Using screwdriver, loosen 3 screws and remove lens.
- Remove 2 screws in bulb holder. Lift up bulb holder and disconnect wires by pulling connectors off bulb holder.
- Raise bulb holder up and lift tab on bulb holder out of slot in housing.

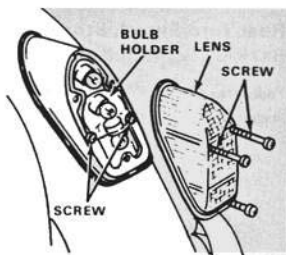



- d. Using 8 mm open end wrench, remove 2 nuts holding housing on underside of fender. Remove housing and gasket from fender.

## 2. Installing Assembly

- a. Fit housing into gasket. Place housing and gasket on fender.  
 b. Screw 2 nuts on studs of housing on underside of fender. Using 8 mm open end wrench, tighten nuts.

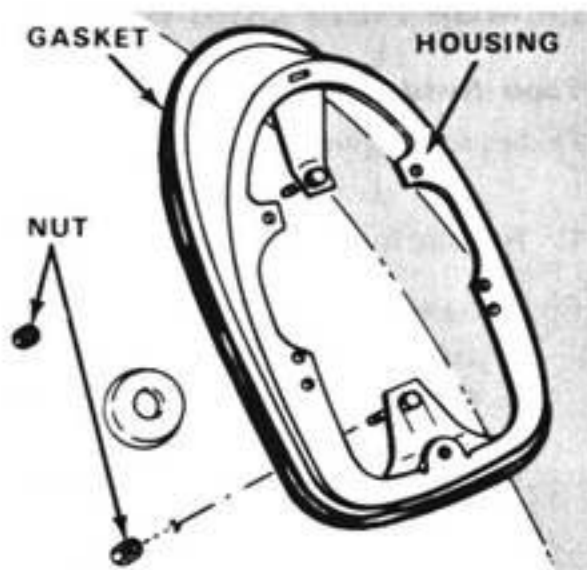

- c. Insert tab on upper edge of bulb holder into slot on housing.  
 d. Connect wires to bulb holder by pushing connector on terminals on holder as follows:

Top bulb	— red wire
Center bulb	— upper terminal — black wire
	— lower terminal — gray wire
Bottom bulb	— right terminal — brown wire
	— left terminal — blue wire

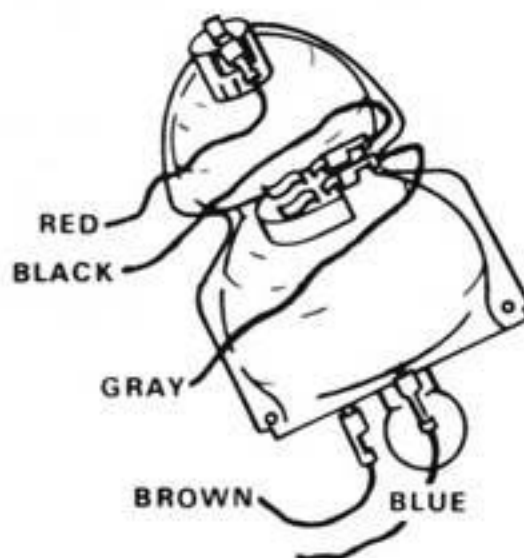

- e. Install 2 screws through bulb holder into housing. Tighten screws.  
 f. Place lens on housing. Tighten 3 screws. Do not overtighten screws.  
 g. Check that tail lights work.

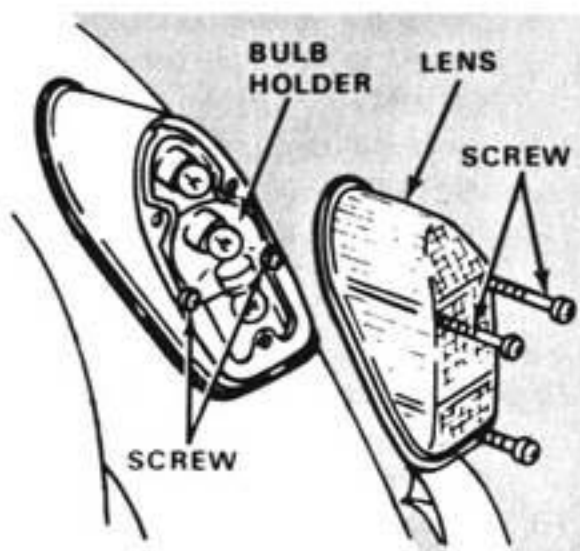

## License Plate Light Bulb

### Tools Needed

Phillips screwdriver, No. 2

### Materials Needed

See bulb chart, page 89.

### 1. Replacing Bulb

- Raise engine hood.
- Using screwdriver, remove 2 screws. Pull lens off bulb holder. Pull holder out of housing.
- Press bulb lightly into socket and turn bulb to left. Lift bulb out.
- Position lugs and bulb in line with slots in socket. Press bulb lightly into socket and turn bulb to right.
- Position plastic grommet on wire in slot in housing.
- Check that gasket is in position on lens. Position lens over holder so that ears on lens and holder are in line.
- Place lens on holder with edges of holder in slots on lens.

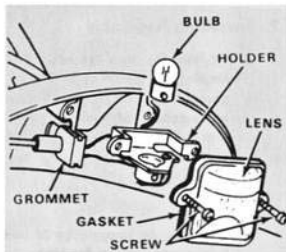

- Position lens and holder in housing so that holes in housing are in line with holes in lens. Install 2 screws. Do not overtighten the screws.
- Check that light works.
- Close engine hood.

## Interior Light

### Tools Needed

Screwdriver, flat blade  $\frac{3}{16}$  inch

### Materials Needed

See bulb chart, page 89.

### 1. Replacing Bulb

- Using the screwdriver, push the metal tab on right side of light. Lift light assembly out to its stops.
- Press on stop on right side of light and lift light all the way out.
- Hold spring at one end of bulb. Hold bulb and lift it out to one side. Remove bulb.
- Install new bulb at one end. Push bulb into spring at other end.
- Press in light. Make sure it is properly seated.
- Check that light works.

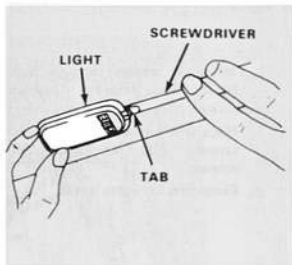

## Fuses

### Tools Needed

None

### Material Needed

Spare fuses: 8 amp — white  
16 amp — red

The fuse box is located under the instrument panel, to the left of the steering column. It is covered by a clear plastic cover. If your car has an air conditioner, the fuse box will be located in the luggage compartment behind the instrument panel cover.

The 8 amp fuse for the back-up lights is located in a holder on a support in the engine compartment near the ignition coil.

On cars with Automatic Stick Shift, another 8 amp fuse is mounted on this support. If this fuse burns out, the transmission cannot be shifted.

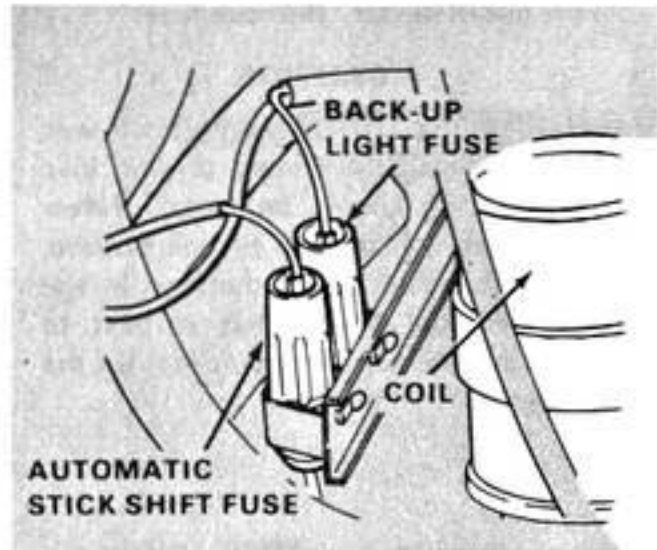

The fuse for the rear window defogger is located in a holder under the rear seat on the left side.

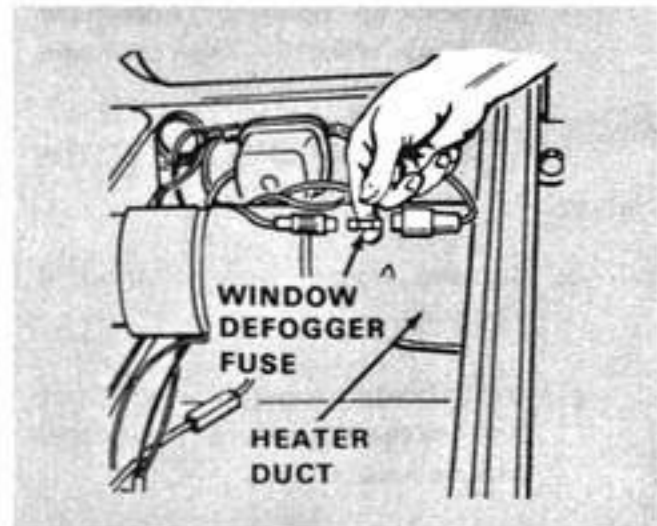

## 1. Replacing a Fuse in Fuse Box

### WARNING

Make sure ignition is off. Remove key from ignition. Replacing a fuse with engine running or ignition on could cause electrical shock.

- Pull plastic cover off fuse box.
- Pull fuse down until top of fuse is out of holder. Remove fuse.

### CAUTION

If a fuse blows again after it was replaced, the cause of the fuse blowing should be found. Never patch a fuse with tin foil or wire. This could cause damage in the electrical system. It is best to carry a few spare fuses in the car.

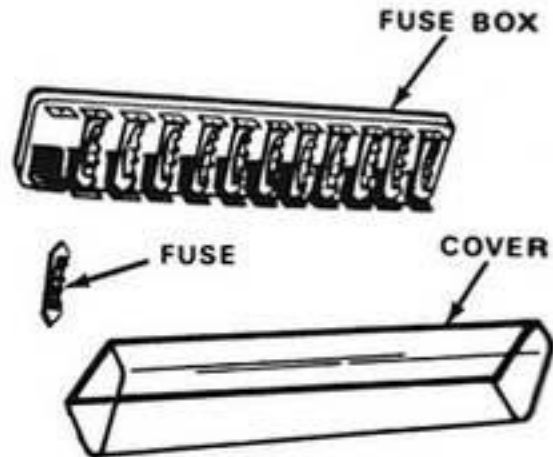

- Place fuse in bottom of holder. Push fuse down and place top of fuse in holder.

### NOTE

Always replace the fuse with the same size. Eight amp fuse is white, and 16 amp fuse is red.

- Press plastic cover on fuse box.

## 2. Replacing Fuse in Separate Holder

- Gain access to fuse as follows:
  - Back-up lights or Automatic Stick Shift — raise engine compartment hood.
  - Rear window defogger — lift up rear seat.
- Remove holder from support if necessary.
- Press holder together and twist both halves. Separate halves and remove fuse.
- Place new fuse in holder and press halves together. Twist both halves to lock them.

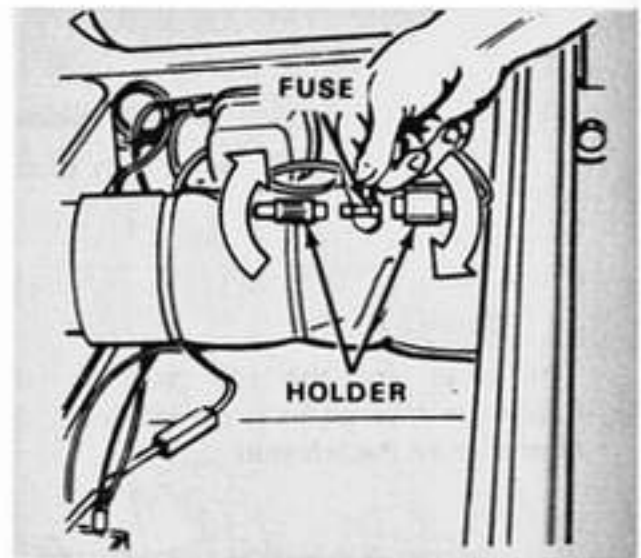

- If necessary, install holder in support. Push instrument cover up in place, install rear seat, or close luggage compartment hood or engine compartment hood.

## Windshield Wiper Blades

### Tools Needed

None

### Materials Needed

Windshield wiper blades. VW Part No.  
111 755 425B

The wiper blades are subject to a certain amount of natural wear. Abrasive dust particles dull the square edges of the blades. When the blades will not wipe the windshield properly, it is best to replace the blades in the interest of safety.

### 1. Replacing Wiper Blades

- Fold arm back. Hold arm, not blade.

#### NOTE

The pivot joint between blade and arm has a stop. This stop prevents the blade from swinging around when the arm is folded back on the windshield.

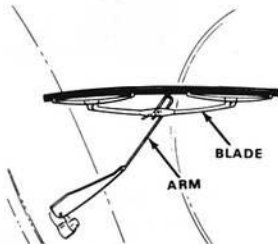

- Move blade to its stop (about 30°). Lift retaining spring and slide blade down arm slightly. Lift blade off upward.
- Position new blade on arm. Make sure arm goes through hole in blade opposite spring.
- Slide blade down past double edge of arm. Slide blade back with arm over spring on blade.
- Place arm back against windshield.

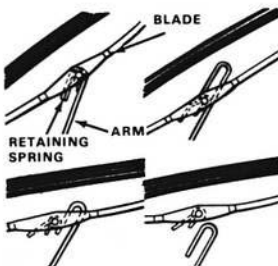

### 2. Replacing Wiper Blade Rubber Fillers

#### Tools Needed

None

#### Materials Needed

Rubber filler. VW Part No. 111 955 429

#### NOTE

Rubber fillers can be replaced without replacing the complete wiper blade.

## 1. Removing Rubber Filler

- a. Remove the wiper blade. See Replacing Wiper Blades, page 101.
- b. Squeeze the short end of the filler between thumb and finger. Twist the filler out of retaining clip. Let clip rest in groove with steel strip.
- c. Repeat step a. on other side of short end. Slide filler back until short end is free of retaining clip.

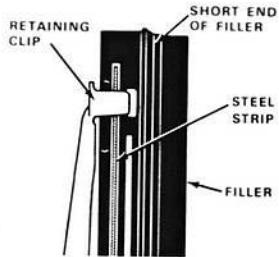

- d. Move the filler to the side and pull the steel strips out.
- e. Slide the filler out of remaining clips.

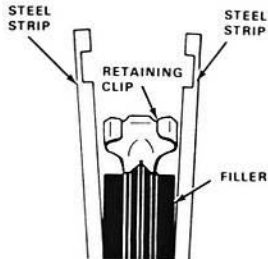

## 2. Installing Rubber Filler

- a. Place both steel strips in grooves of new filler. Make sure notches in strips face the filler.
- b. Hold filler so that strips are kept in filler. Carefully slide filler into retaining clips. Start at open end of filler.

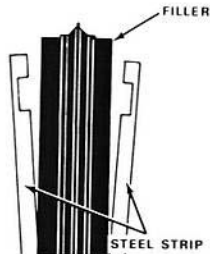

- c. When you reach the closed end of filler, apply gentle but firm pressure on filler until clip rides over raised edge next to recess. Make sure clip rides in recess of filler.
- d. Install wiper blade. See Replacing Wiper Blades, page 101.

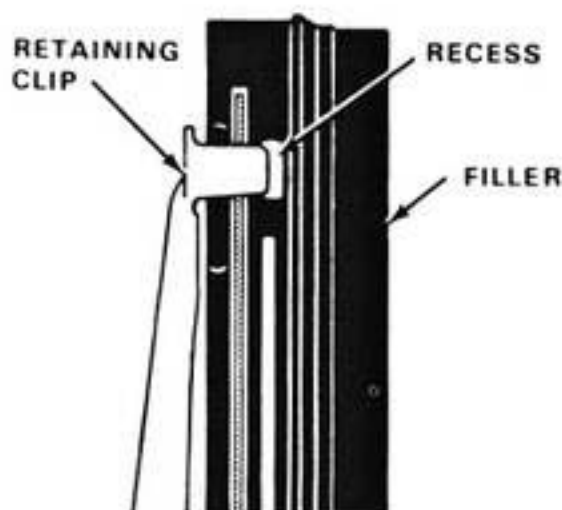

## Windshield Washer Spray Jets

### 1. Adjusting Spray Jets

- a. Insert a fine needle in jet opening. Move the opening in the proper direction.
- b. Operate windshield washer and check that water hits windshield properly. Reset spray jets as necessary.

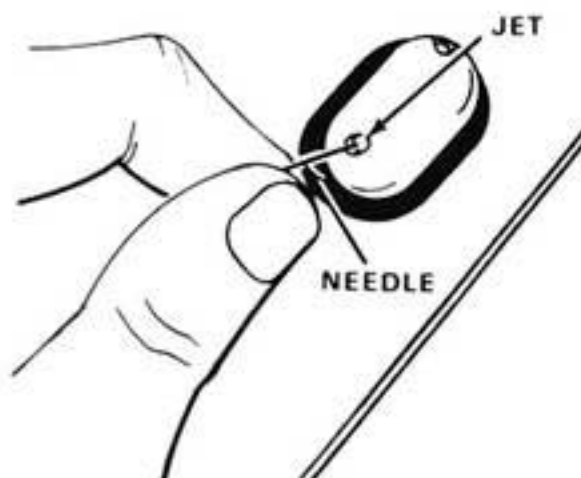

### 2. Cleaning Spray Jets

- a. Clean the jets by inserting a fine wire in them.
- b. Adjust the jets as necessary.

## Checking Tire Condition

### **Tools Needed**

Tire pressure gauge

### **Materials Needed**

None

Tire life and the driving characteristics of the Volkswagen are directly related to tire pressure. Because every tire loses a certain amount of pressure, you should check it at least once a week.

For long high-speed driving, tire pressure should be increased 3 pounds per square inch at each wheel. Do not exceed the maximum pressure given on the tire. A sticker inside the glove compartment lists recommended tire pressures.

To pressurize the windshield washer sufficiently, the spare tire should be kept at a maximum pressure of 42 pounds per square inch. Disconnect the hose to the windshield washer container to check or increase pressure.

To achieve best all around handling, replace all four tires if possible. If this is not possible, replace tires in pairs on the front or rear. Do not mix tires of different design, size or tread pattern. When switching to snow tires, use snow tires on each wheel. Never mix snow tires with regular tires. All new tires tend to be slippery, so break them in by driving at moderate speeds for the first 60 to 100 miles. Radial and studded tires should be driven at moderate speeds for the first 200 miles.

## 1. Tire Wear

- a. The original tires on your car have built-in tread wear indicators. Molded into the bottom of the tread grooves, they will appear as  $\frac{1}{2}$  inch bands when tread depth is down to  $\frac{1}{16}$  of an inch. Replace when wear approaches this limit.
- b. Uneven wear can be caused by several factors:
  - Rapid wear at shoulder indicates under inflation.
  - Rapid wear at center indicates over inflation.
  - Cracked treads indicate under inflation or excessive speed.
  - Wear on one side, feathered edges, or bald spots indicate excessive camber, incorrect toe in and wheel imbalance respectively. Return the car to your VW dealer for diagnosis and repair.
- c. Worn tires showing cuts and bruises are susceptible to sudden flats at any speed. Replace damaged tires.

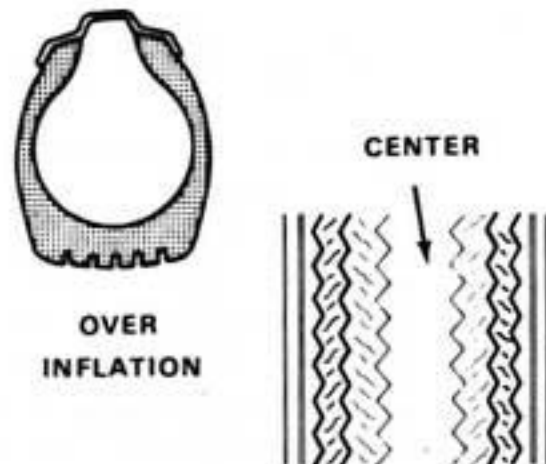
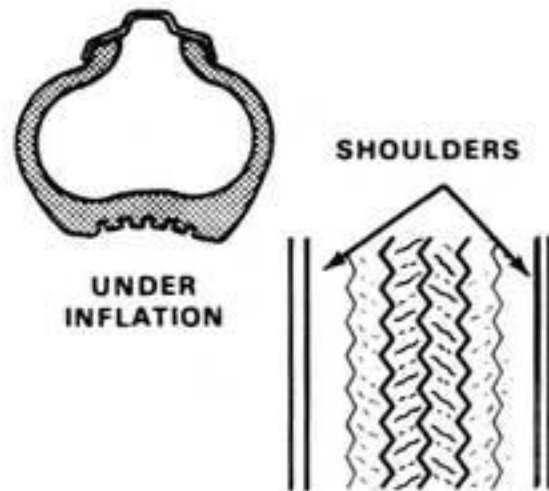
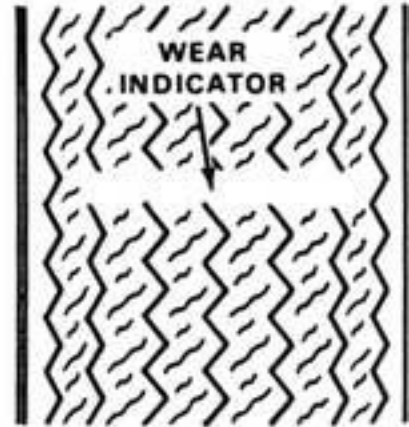



## Wheels

### Tools Needed

Jack  
Breaker bar  
Hub cap puller  
Socket wrench, 19 mm  
2 Support stands  
Torque wrench, 0-150 foot-pounds,  
 $\frac{3}{8}$  inch drive  
4 Wheel chocks

### Materials Needed

None

Jobs requiring removal and installation of wheels range from changing a flat to wheel rotation. During routine jobs, do not change wheels from one point on the car to another. This interferes with planned wheel rotation. Following any task which requires removing and installing a wheel, check the tire pressure at the first opportunity. A sticker inside the glove compartment lists recommended tire pressures.

### 1. Removing a Wheel

- a. Remove the hub cap.

#### NOTE

If tool kit contains a hub cap remover, insert it in holes in rim of cap. Then place breaker bar through the remover and pry cap loose by bracing bar on the wheel rim.

If tool kit does not contain a hub cap puller, use the breaker bar. Place the flat end between the hub cap and rim and pry the cap off.

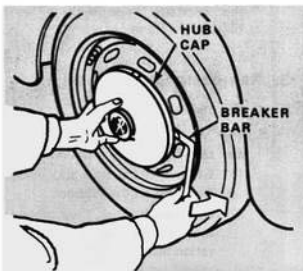
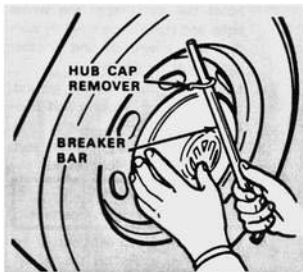

- b. Using the socket wrench and breaker bar, loosen each wheel bolt one turn counterclockwise. Do not remove bolts.
- c. Block wheels and insert jack as directed in Chapter 4, Jacking and Supporting, page 14.
- d. Raise the car and place it on support stands as directed in Chapter 4, Jacking and Supporting.
- e. Remove the 4 wheel bolts and place them in the hub cap.
- f. Remove the wheel.

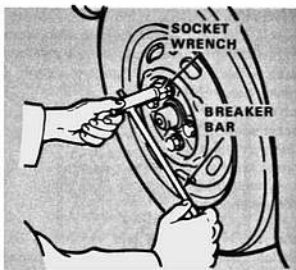

## 2. Installing a Wheel

- a. Place the wheel against the wheel hub. Turn the wheel until the holes line up. Install the wheel bolts and tighten them lightly with the socket wrench and breaker bar to seat the wheel.
- b. Lower the wheel to the ground. See Chapter 4, Jacking and Supporting, page 14.
- c. Working diagonally, torque each wheel bolt to 110 foot pounds.

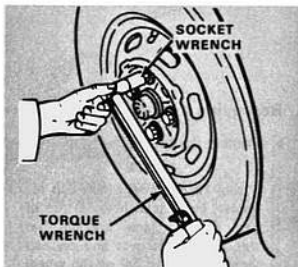

**WARNING**  
Proper torquing is important.

- d. Place the hub cap over two of the four raised spots on the wheel. Snap the hub cap on by striking the opposite edge with a firm blow of the hand.

## 3. Removing Spare Wheel

- a. Set parking brake.
- b. Open the luggage compartment.

### *On the Beetle*

- (1) Lift the spare free and place it upright on the bumper.
- (2) Disconnect the windshield washing container pressurization hose.

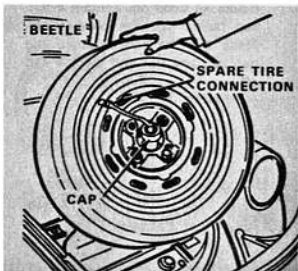

- (3) Remove the two wedges that hold the windshield washer container in the rim and separate the container.

#### ***On the Super Beetle***

- (1) Lift the compartment deck cover.
- (2) Disconnect the windshield washing container pressurization hose. Lift the wheel free.

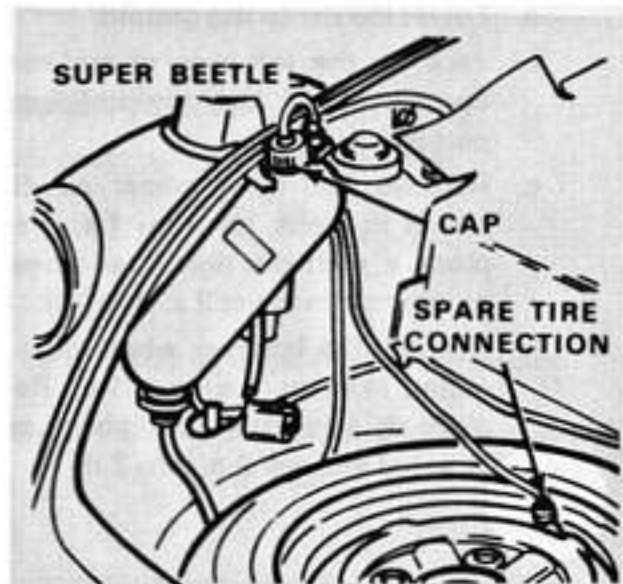

## **4. Rotating Tires (Five-Wheel Interchange)**

### **WARNING**

Never shift snow tires across the car. This will reverse the direction of rotation and result in considerable loss of traction. For snow tire rotation, see Rotating Tires (four wheel interchange - standard and snow tires).

- Open the luggage compartment and remove the spare.
- Jack up the right side of the car. See Chapter 4, Jacking and Supporting, page 14.
- Remove the right front wheel as directed in steps 1.a. thru 1.e. Replace it with the spare wheels as directed in steps 2.a. thru 2.d.
- Remove the right rear wheel as directed in steps 1.a. thru 1.e. Replace it with the right front wheel as directed in steps 2.a. thru 2.d.

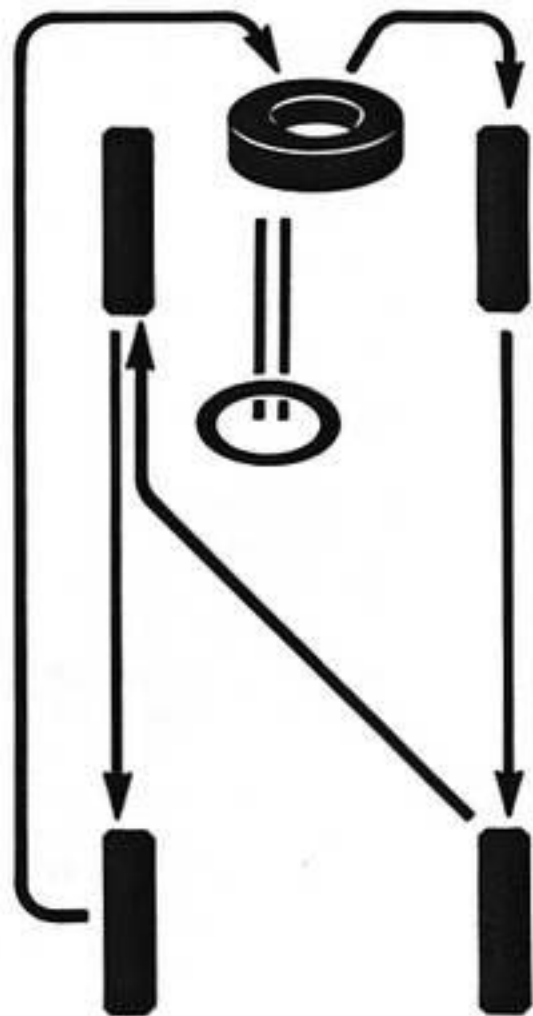

- e. Lower the car to the ground.
- f. Jack up the left side of the car. See Chapter 4, Jacking and Supporting, page 14.
- g. Remove left front wheel as directed in steps 1.a. thru 1.e. Replace it with the right rear wheel as directed in steps 2.a. thru 2.d.
- h. Remove the left rear wheel as directed in steps 1.a. thru 1.e. Replace it with the left wheel as directed in steps 2.a. thru 2.d.
- i. Lower the car to the ground.
- j. Place the remaining wheel in the luggage compartment as a spare.
- k. Check tire pressure all around. Service as required.
- l. Hook up windshield washer container pressurizing hose to the spare.
- m. Close the luggage compartment.
- n. Store the jack.

## 5. Rotating Tires (Four-Wheel Interchange/Standard and Snow Tires)

- a. Jack up the right side of the car. See Chapter 4, Jacking and Supporting, page 14.
- b. Remove the right front and right rear wheels as directed in steps 1.a. thru 1.e.
- c. Place the wheel removed from the rear on the front, and that removed from the front on the rear as directed in steps 2.a. thru 2.d.
- d. Lower the car to the ground.
- e. Jack up the left side of the car. See Chapter 4, Jacking and Supporting, page 14.
- f. Remove the left front and left rear wheels as directed in steps 1.a. thru 1.e.
- g. Place the wheel removed from the rear on the front, and that removed from the front on the rear as directed in steps 2.a. thru 2.d.
- h. Lower the car to the ground.
- i. Store the jack.

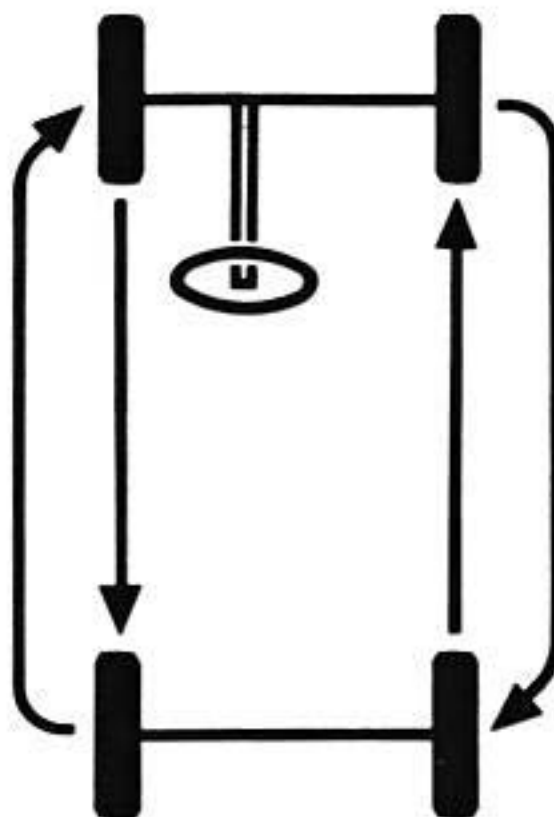

## 6. Snow Tire Procedure

- a. Always install snow tires on all four wheels.
- b. When removing snow tires, mark direction of wheel rotation prior to removal so tires can later be installed on same side of car.

## Front Seats

### **Tools Needed**

Screwdriver,  $\frac{7}{16}$  inch  
Rag

### **Materials Needed**

Multi-purpose grease, lithium base

The front seats of your car can easily be removed for cleaning or lubrication of the tracks.

If the seats become hard to slide, clean the runners with a cloth and apply a light coat of grease on top and bottom of runner.

### **1. Removing Front Seat**

- a. Lift adjustment lever and slide seat forward until it touches the stop.
- b. Using a screwdriver, depress the leaf spring and lifting adjustment lever, slide seat forward about  $1\frac{1}{2}$  inches.

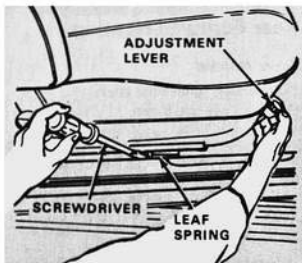

- c. Disconnect spring from tab on seat track.
- d. Slide seat all the way forward. Lift it out of car.

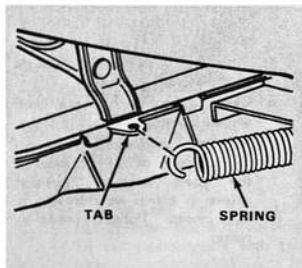

## 2. Installing Front Seat

- While standing outside the car, hold the seat parallel to the runners, with the seat backrest forward for better balance.
- Position seat so that tracks on seat are around runners. Slide seat back on runners.
- Connect spring to tab on seat track.

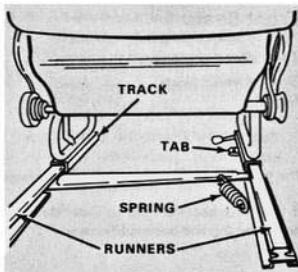

## Rear Footwell Heating

### Tools Needed

Screwdriver,  $\frac{1}{8}$  inch flat blade  
Open end wrench, 8 mm

### Materials Needed

None

If no or very little heat is felt in the rear footwell when control levers are in the on position, the heater flaps may need adjustment.

### 1. Adjusting Rear Footwell Heater Flaps

- Lift up back seat. Take seat out of car. Fold rear floor mat out of way.
- Push out bottom of kickboards until they can be removed.
- Using screwdriver, loosen both screws in clamp.
- Position temperature control levers, along side front seat, in the down position. Position cables in clamp so that flap is fully closed. Tighten screws in clamp.

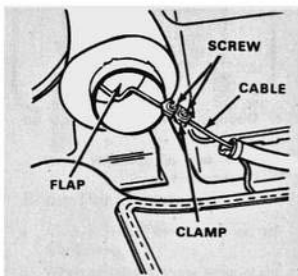

- e. Move control lever up and down and check the flap opens and closes completely.
- f. Place top edges of kickboards under support. Slide bottom of kickboards back. Make sure heater outlet is in line with opening in kickboard.
- g. Start up engine. Move the control lever up. Using your hand, check for air movement at the heater vents.
- h. Before installing rear seat, make sure all tools are removed. Place safety belt buckles in position to be placed on seat.
- i. Place seat in position in car. Slide back edge of seat into position.

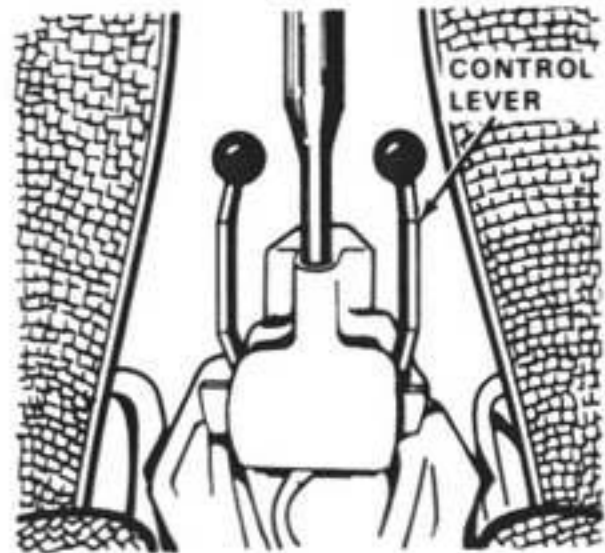

Lower front edge of seat down on support. Push seat back until it drops into position.

- j. Fold rear floor mat back down.

## 2. Positioning Heater Flap Cables

### WARNING

Follow the jacking procedures in Chapter 4, Jacking and Supporting, page 14. Do not work under the raised car until it is on support stands.

- a. Drive your car to a level area.
- b. Raise right rear side of car and support it with support stands.
- c. Using the 8 mm wrench, loosen the bolt on link attached to the heat exchanger lever.
- d. Make sure link is all the way to the front of the slot in the lever.
- e. Using 8 mm wrench, tighten bolt on link.
- f. Lower the car to the ground. See Chapter 4, Jacking and Supporting, page 14.

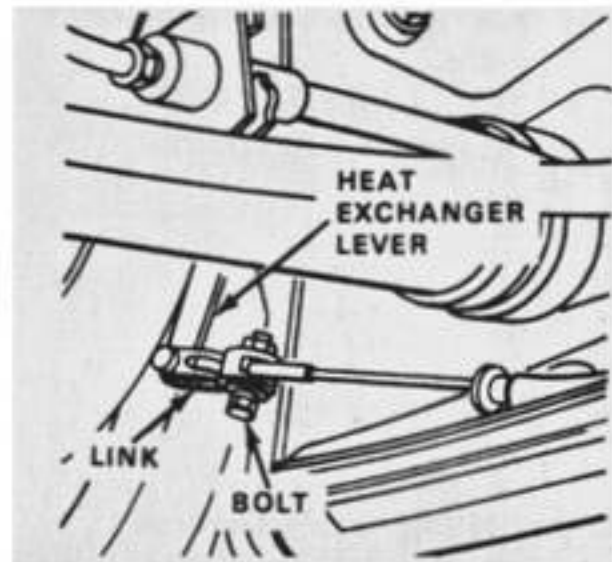

- g. Start engine. Pull temperature control lever. Check for air blowing out heater vents with your hand.

## Front Bumper

### Tools Needed

Open end wrench, 13 mm  
Oil can (for oiling bolts and nuts)

### Materials Needed

Engine oil

### 1. Removing Front Bumper

- Using 13 mm wrench, remove 2 bolts holding horn bracket and left bumper bracket to side panel.
- Remove remaining 4 bolts (1 on left, 3 on right) holding bumper brackets to side panel.

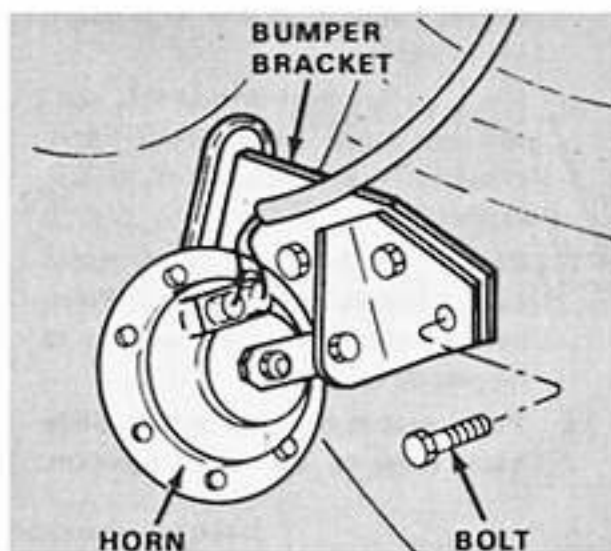

- Pull brackets out of slots in fender.
- Remove 3 nuts on each side holding brackets on bumper.

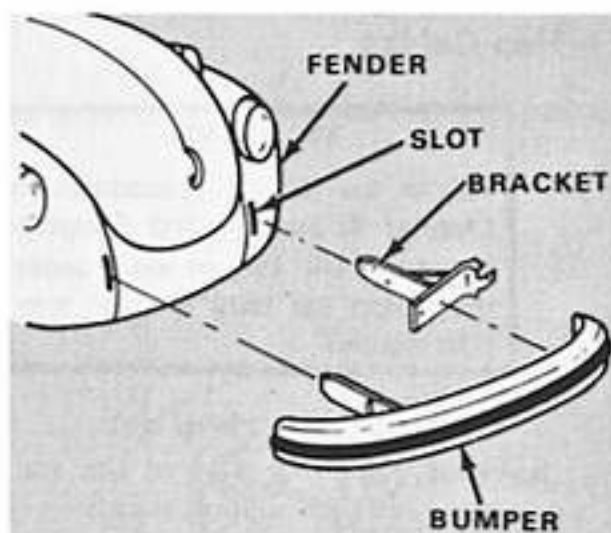

### 2. Installing Front Bumper

- Check grommets in fenders for damage. If grommets are damaged, replace them.
- Apply a light coat of oil to all bolts and nuts.
- Place brackets on bumper and screw nuts on studs through brackets. Using 13 mm wrench, tighten nuts.

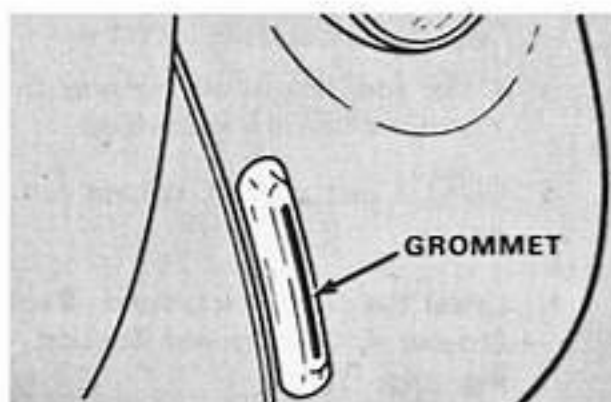



- d. Slide brackets into slots in fenders. Position horn bracket on bumper bracket. Loosely thread 2 bolts through brackets into left side panel. Do not tighten bolts.
- e. Start other 4 bolts (1 on left, 3 on right) into side panels.
- f. Make sure space between bumper and fender is even on both left and right sides. Tighten 6 bolts.

## Rear Bumper

### Tools Needed

Open end wrench, 13 mm  
Oil can (for oiling bolts and nuts)

### Materials Needed

Engine oil

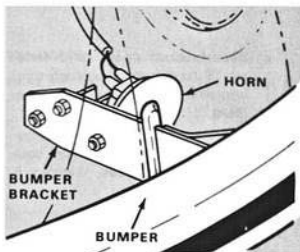

### 1. Removing Rear Bumper

- a. Using 13 mm wrench, remove 3 bolts holding each bumper bracket to side panels.

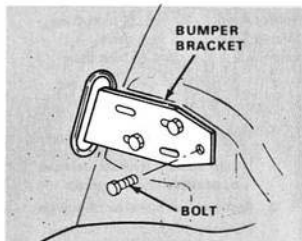

- b. Pull brackets out of slots in fenders.
- c. Using 13 mm wrench, remove 3 nuts on each side holding brackets to bumper.

### 2. Installing Rear Bumper

- a. Check grommets in fenders for damage. Replace any damaged grommets.
- b. Apply a light coat of oil to all bolts and nuts.

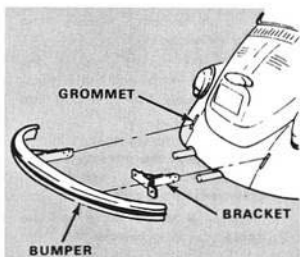

- c. Slide brackets into slots in fenders. Start 6 bolts (3 on each side) into side panels. Do not tighten them.
- d. Make sure space between bumper and fenders is even on both left and right sides. Tighten 6 bolts.

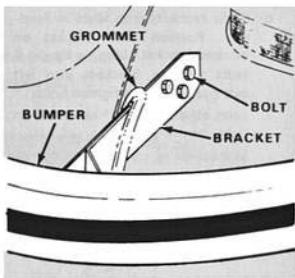

## Rubber Molding For Bumpers

### Tools Needed

Socket wrench, 10 mm,  $\frac{3}{8}$  inch drive  
 Sliding T-handle,  $\frac{3}{8}$  inch drive  
 Extension, 2  $\frac{1}{2}$  inches,  $\frac{3}{8}$  inch drive

### Materials Needed

Rear rubber molding — VW Part No.  
 113 707 401  
 Front rubber molding — VW Part No.  
 113 707 201A

### 1. Removing Molding

- a. Using socket wrench, remove 2 nuts at either end of bumper.
- b. Remove bolt in center of bumper.
- c. Remove molding from bumper.

### 2. Installing Molding

- a. Position one stud on molding through bumper. Loosely start the nut on the stud.
- b. Align the center hole in the bumper with the hole in the molding. Loosely start the bolt into the molding.
- c. Hold the molding against bumper. Position the molding so that second stud can be put through bumper and nut started.
- d. Tighten 2 nuts at either end and bolt in center of bumper.

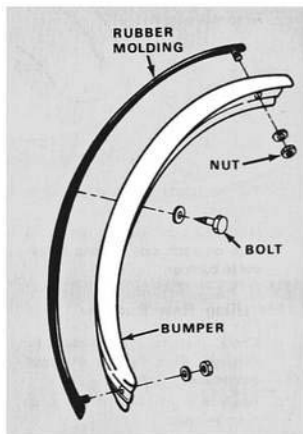

## Front Fenders

### Tools Needed

Open end wrench, 8 mm  
Open end wrench, 13 mm  
Offset box wrench, 13 mm  
Phillips screwdriver, No. 1  
Phillips screwdriver, No. 2  
Screwdriver, 1/8 inch flat blade

### Materials Needed

Rubber washer — VW Part No.  
111 821 545

### 1. Removing Front Fender

- a. Remove turn signal. See Front Turn Signal and Parking Light Assembly, page 94.
- b. Pull gasket for light assembly down through fender.
- c. Remove headlight. See Headlight Assembly, page 91.
- d. Detach wire terminal from connector by inserting the screwdriver into the small slot below the terminal. Pull the wire terminal out of connector. Repeat for other 2 terminals.
- e. Pull cable and protective hose back out of headlight housing.
- f. Remove front bumper. See Front Bumper, page 112. Disconnect wires from horn and remove horn.
- g. Using the 13 mm wrenches, remove nut bolt and washer holding fender to running board.
- h. Remove remaining 8 bolts holding fender.
- i. Remove fender and beading.

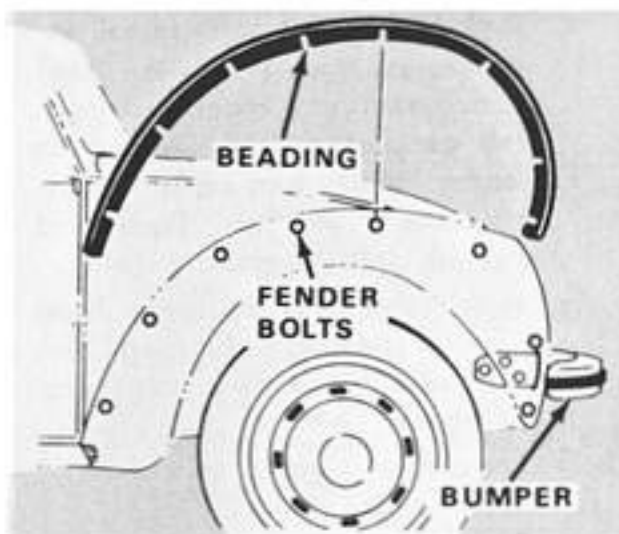
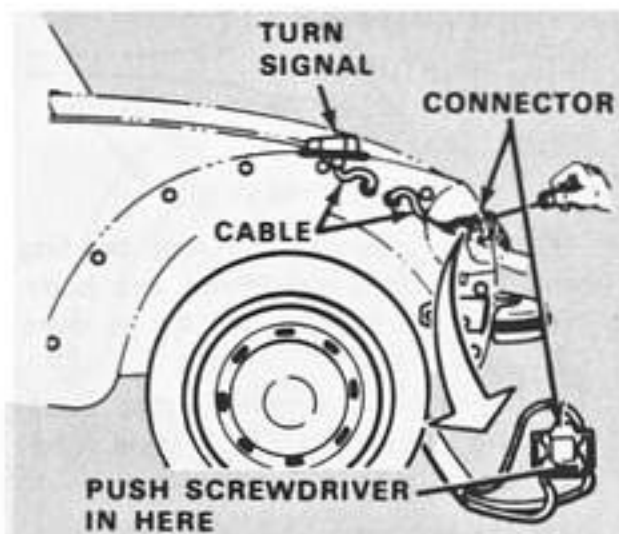

## 2. Installing Front Fender

- a. Position fender against car body and loosely start all bolts.
- b. Place new rubber washer between fender and running board. Install bolt and nut. Do not tighten.

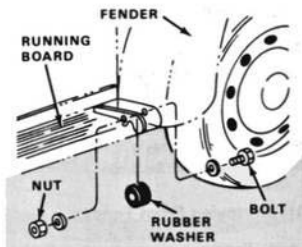

- c. Using your hand, press beading down between fender and body. Make sure the beading is even around fender.
- d. Tighten bolts. Check that beading remains in place while tightening bolts.

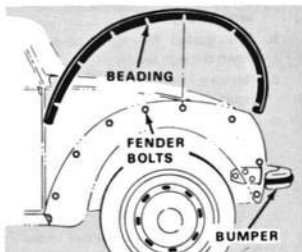

- e. Install grommet for bumper bracket in fender. Install bumper. See Front Bumper, page 112. Connect wires to horn.
- f. Push gasket for turn signal assembly up through fender. Position gasket on fender and push tab on gasket down in hole in fender. Install turn signal assembly. See Front Turn Signal and Parking Light Assembly, page 95.
- g. Push cable and protective hose through headlight housing. Install wire terminals in connector as follows:

Top center — yellow wire  
Left — white wire  
Right — brown wire

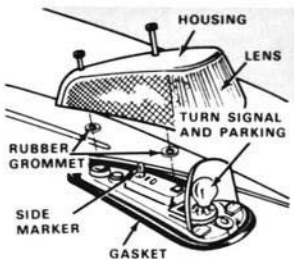

- h. Install headlight assembly. Check headlight setting. See Headlight Assembly, page 92.

## Rear Fenders

### Tools Needed

Open end wrench, 8 mm  
Open end wrench, 13 mm  
Offset box wrench, 13 mm  
Phillips screwdriver, No. 2

### Materials Needed

Rubber washer — VW Part No.  
111 821 545

### 1. Removing Rear Fender

- Remove tail light assembly and gasket. See Tail Light Assembly, page 96. Pull wires and grommet down out of fender.
- Remove rear bumper. See Rear Bumper, page 113. Remove grommet for bumper from fender.

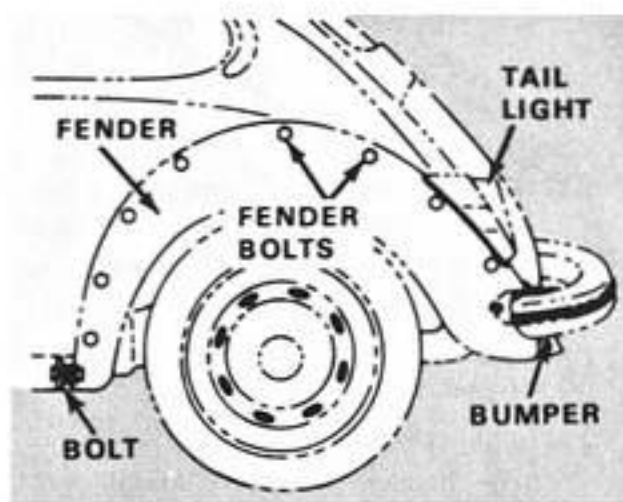

- Remove nut, washer, and bolt holding running board to rear fender.
- Remove 9 bolts and washers holding fender to body. Remove top 2 bolts last to prevent fender from bending.
- Remove fender and beading from body.

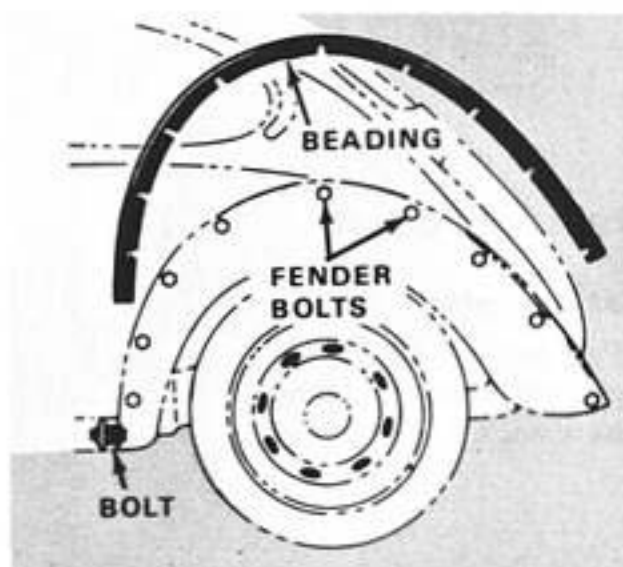

## 2. Installing Rear Fender

- a. Position fender against car body. Loosely install 9 bolts and washers.
- b. Place a new rubber washer between fender and running board. Loosely install the bolt, washer, and nut through fender and running board.
- c. Press beading by hand down between fender and body. Tighten all bolts. Make sure beading is even all around fender.
- d. Install bumper. See Rear Bumper, page 113.
- e. Pull tail light wires and grommet up through fender. Install tail light. See Tail Light Assembly, page 97.
- f. Check that tail light works properly.

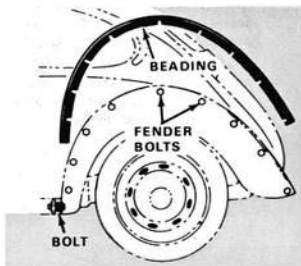
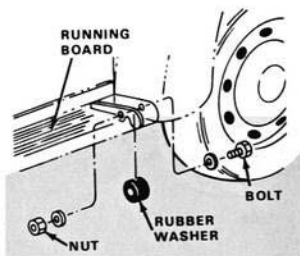

## Running Board

### Tools Needed

Offset box wrench, 10 mm  
Open end wrench, 13 mm  
Box wrench, 13 mm

### Materials Needed

2 Rubber washers — VW Part No.  
111 821 545

## 1. Removing Running Board

- a. Using 13 mm wrenches, remove bolts, nuts, and washers holding running board to front and rear fenders. Remove 2 rubber washers from between running board and fenders.
- b. Using 10 mm wrench, remove 4 bolts holding running board to body. Remove running board.

## 2. Installing Running Board

- a. Position running board against car body. Loosely start 4 bolts through running board and body.
- b. Place 2 rubber washers between running board and fenders. Loosely install 2 bolts, nuts, and washers through running board and fenders.
- c. Using 10 mm wrench, tighten 4 bolts holding running board to body. Using 13 mm wrenches, tighten 2 bolts and washer holding running board to fenders.

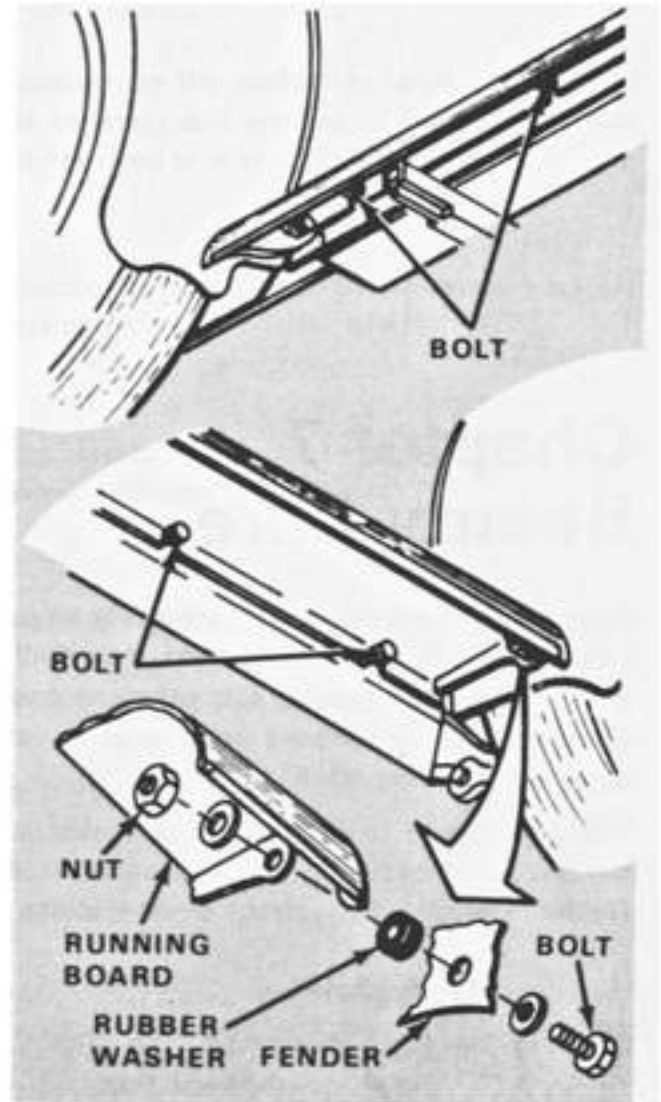

## Chapter 7

# Beauty Care

Even the finest paint needs a certain amount of care. The paint on your car is constantly being attacked by sunlight, rain, industrial fumes, soot, dirt and dust. Winter conditions are worst of all because salt solutions used on the roads to melt ice and snow are damaging to painted surfaces and corrosive to metal. Because of this, it is best to clean and wax your car more often in the winter.

The items listed below have been made especially for your VW and will help you preserve the beauty of its finish. All of these items are available at your local Authorized Volkswagen Dealer. Detailed instructions on how to use them are printed on the containers.

	<i>Application</i>	<i>Volkswagen Product</i>
Cleaning	— Car, convertible top, upholstery, whitewall tires	All Purpose Cleaner — ZVW 243 101
	— Chrome	Chrome Cleaner and Protection — 000 096 061
	— Windshield	Windshield Washer Anti-Freeze and Solvent — ZVW 241 101
Polishing	— Paint	Combination Car Cleaner and Wax — ZVW 241 109
		Paint Polish — 000 096 001
Waxing	— Paint	Classic Car Wax — ZVW 246 101
Preserving chrome		Chrome Preservative — 000 096 067
Touching up paint		Touch-up Paint, All Colors

### Washing

Wash car in clear water. Do not wash it in direct sunshine. To avoid scratching paint, rinse sponge frequently.

If dirt cannot be removed with clear water, use the All Purpose Cleaner with the water. After washing, rinse all traces of Cleaner off with clear water. Wipe the car dry to avoid water spots.



## **Waxing**

Wax your car as often as necessary. If water remains on the surface in large patches and does not form beads and roll off, your car needs cleaning and waxing. If Combination Car Cleaner and Wax is used to clean your car, you do not need to wax it afterwards.

## **Polishing**

If the paint has lost its shine and gloss and cannot be brought back with wax, your car needs polishing. After polishing, you must wax the car.

## **Removing Tar Spots**

If you get tar on your car, remove it as soon as possible with tar remover. Rinse off all traces of remover with a soap powder solution (water and shampoo).

## **Removing Insects**

Clean off dried-on insects with an insect remover. Rinse off traces of remover with water and shampoo afterwards.

## **Removing Tree Residue**

Cars parked under certain trees during the summer are often covered with sticky spots. Remove these spots as soon as possible with a shampoo. You should wax the car afterwards.

## **Caring for Chrome**

Treat chrome parts with a chrome cleaner or polish. To protect the chrome on your car, especially during the winter, coat the chrome with Volkswagen's Chrome Cleaner and Protection.

## **Touching up Paint**

Minor paint damage, such as scratches and stone chips, can be easily touched up with a paint stick. The paint stick is available at your Authorized VW Dealer. In the spare wheel compartment you will find a sticker showing a number. This number is the code for the paint color on your car.

## **Cleaning Windows**

Clean the windows with a sponge and warm water. Dry them with a chamois. Do not use this chamois for the paint. The cleaner and polish from the paint will cause streaks on the windows. Remove streaks with a good windshield cleaner. Do not forget to clean the wiper blades.

## **Caring for Windshield Wiper Blades**

During dry periods, the blades get clogged with tar, oil, and insects. Clean them from time to time by removing them and cleaning them with a hard brush and alcohol or a strong detergent solution. Blades should be replaced as often as necessary, as determined by how effectively they wipe the windshield.

## **Caring for Door and Window Weatherstrips**

In order for weatherstrips to seal properly, they must be undamaged and flexible. To keep the original flexibility of the rubber, coat the weatherstrips with talcum powder or silicone spray occasionally.

## **Airing the Body**

If your car is kept in a closed garage for long periods, the garage and the interior of the car should be aired from time to time. This will prevent the formation of mold and damp stains inside the car.

## **Cleaning Cloth Upholstery**

Clean cloth upholstery with a vacuum cleaner or a fairly hard brush. Remove spots with a lukewarm soap solution. Grease and oil spots can be treated with spot remover. Dampen a clean, plain cloth with the cleaner. Do not pour the liquid on the material as this will leave marks. Remove the spot by rubbing with a circular motion and working in toward the center of the spot.

## **Cleaning Leatherette**

Clean leatherette parts of the headlining, side trim panels, and seats with a soft cloth or brush. When it is very dirty, use Volkswagen's All Purpose Cleaner. The seats and back rests should be cleaned with dry foam cleaner only. Liquid cleaners will penetrate the fabric. Grease or paint spots should be wiped off before they dry, when possible. If they dry, they can be removed with All Purpose Cleaner. Remove shoe polish marks with turpentine. Be very careful because this will damage the dust-repellent surface of the leatherette if applied for too long a time. After cleaning, rub the material dry with a soft cloth. Do not use so-called preservatives. They do not soak into the material and merely collect dust that will soil your clothing.

## **Caring for Front Seats**

If front seats become hard to slide, clean the runners with a cloth. Then apply a light coat of grease to top and bottom of runners. For removing and installing the seats, see Front Seats, page 109.

## **Caring for Convertible Tops**

The top does not require any special care. However, you should clean the plastic material regularly. If it is very dirty, clean the top with Volkswagen's All Purpose Cleaner or a soap powder solution. You can use a hard brush to remove dirt from the grained surface of the material but be careful to avoid scratching the paint. After washing the top, rinse the entire car with clear water. Do not use paint thinner, chlorine-based spot removers, or similar solutions to remove spots in the top material. They will damage it. Remove stubborn spots by wiping with a cloth moistened with appropriate cleaner. After removing spot, rinse well with a lukewarm soap solution.

Clean the pivot points of the top linkage occasionally with a dry cloth. Apply a few drops of oil to the pivot points. Hold a cloth under the pivot points to catch any excess oil. Then, wipe pivot points dry to make sure that oil does not drip on the top material.

Noises caused by friction between window frames of the Convertible and the rubber weatherstrips can be stopped by rubbing in some talcum powder or using silicone spray.

# Chapter 8

## Accessories

Your Volkswagen has a personality all its own. Fine. Next give it a personality all your own. You do this by adding the accessories that make your VW really yours.

Here, and on the following pages, we've listed accessories that you can install yourself.

While no directions for installation are given here, you'll find instructions accompanying the accessory when you buy it.

Of course, your dealer stands ready to fit them himself should you prefer.

For additional accessories, check your dealer's official accessory brochure.

### Exterior Accessories

#### 1. Rear-Mounted Ski Rack

Built-in lock not only locks skis and poles to the rack, but also locks the rack to the rear of your car. Comes with steel holders that firmly support the ends of the skis. Holds two pairs of skis and poles. Easy to mount and remove.

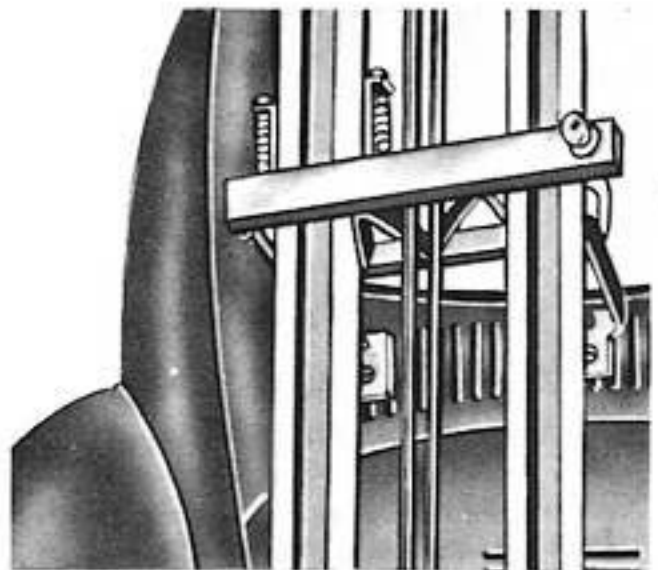

**2. "Formula Vee" Bumper Overriders**

Provide extra protection on the road and when parked. Have live rubber strips to cushion against shocks. Heavy chrome finish matches that on your Volkswagen.



**3. "Formula Vee" Taper Tip Exhaust Pipes**

Add a sporty look and sound to your car. Improve performance and gas consumption. Reduce exhaust back pressure. Tapered pipes are heavily chrome plated.

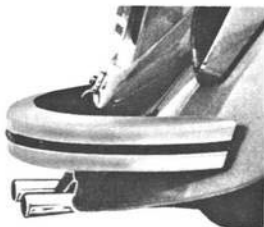

**4. "Formula Vee" Fanfare Horn Set**

Double-toned high and low pitch horns, provide a stronger sound for road travel. Mount securely on the front bumper. Heavy chrome finish.



## 5. Vent Shades

Dress up your Volkswagen while giving draft-free ventilation. Reduce window fogging. Keep rain out. Keep the car cooler in summer.



## 6. Gravel Guard

Available for front and rear fenders to protect them from flying debris. Protect where damage is most likely to occur. High polished stainless steel.

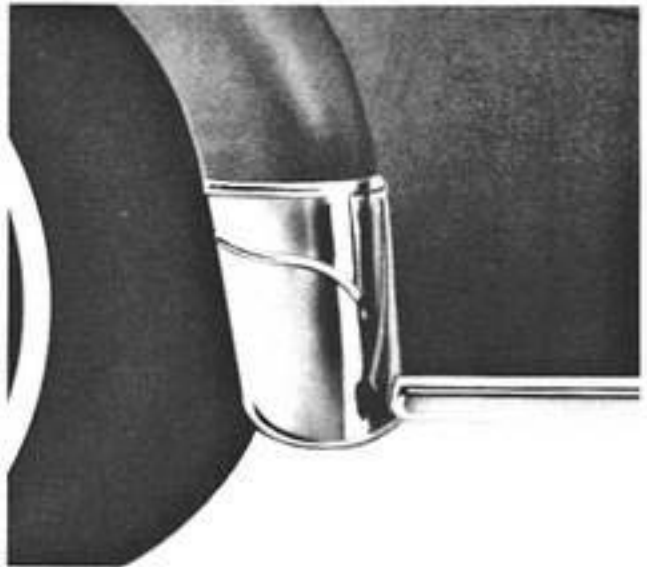

## 7. Trim Group

Designed to guard areas most commonly damaged while brightening the car's appearance. Door corner guards, door post kick plates and door sill protector keep passengers from scuffing your VW as they get in and out. Door edge guards prevent scratches and paint chipping along the edge. Vent shades protect your car and your passengers from wind and rain and reduce fogging by enabling you to keep vent window open during a downpour. Made of stainless steel.

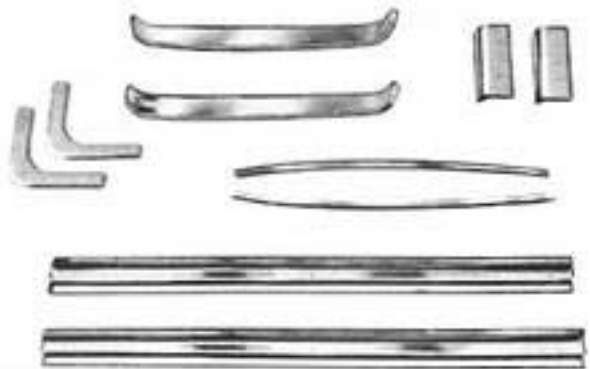

## Interior Accessories

### 1. "Formula Vee" Gearshift Knob

Adds a touch of elegance. Available in walnut or black leather-grained covering. Choice of Wolfsburg Crest or shift pattern insert.

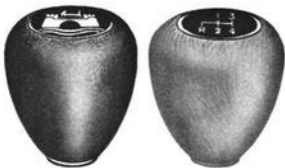

### 2. "Formula Vee" Sports Gearshift Lever

For manual transmissions.

Gives your car a sporty look and driving feel. Has a drilled chrome steel shaft. Walnut covered knob with Wolfsburg City Crest. Has PCV boot. Slips over original shift lever. Clamps down on base.



### 3. Cigarette Lighter

Automatic lighter. Traditional design provides safe, easy light while driving.



#### 4. Utility Light

Installs either in engine or luggage compartment. Light goes on and off when hood is opened or closed.



#### 5. Door Storage Compartment

Compartment 6½ inches deep provides storage for maps and other items. Can be installed on either or both doors. Made of molded vinyl in black pebble grain finish, with protective trim edging along the top. Matches the interior of your VW.



#### 6. Parcel Shelf (Beetle Only)

Installs below the dashboard. Provides ample room for storing maps, gloves or small packages. Mesh webbing is easy to clean. Raised edge prevents articles from sliding off.



**7. "Formula Vee" Steering Wheel Cover**

Vinyl-surfaced porotherm wheel cover keeps your hands warm in winter and dry in summer. Provides a more comfortable feel on the wheel. Installs easily.





**Pages 41, 42, 43 and 129**

The valve clearance as listed on these pages should be changed to read 0.006 inch (0.15 mm).

# Chapter 9

## Technical Data

### Engine

Four cylinder, four stroke, horizontally opposed, in rear. Air cooling by fan, thermostat-controlled.

Pressure oil feed with gear-type pump. Oil cooler. Mechanical fuel pump.

Downdraft carburetor with automatic choke and accelerator pump.

Oil bath air cleaner with thermostat-controlled air pre-heating. Exhaust emission control system.

Activated charcoal filter in the fuel system.

Bore	3.35 in. (85.5 mm)
Stroke	2.72 in. (69 mm)
Displacement	96.6 cu. in. (1584 cc)
Compression ratio	7.3:1
Valve clearance with engine cold	Intake and exhaust .004 in. (0.10 mm)

### Transmission

#### Manual Transmission

Single plate, dry clutch.  
Clutch pedal, free play:  $\frac{3}{4}$  to  $\frac{3}{8}$  (10-20 mm).  
Baulk synchronized four-speed gearbox and bevel gear differential in one housing.  
Drive shafts with two constant velocity joints per shaft.

Gear ratios			
1st gear	3.80:1	4th gear	0.88:1
2nd gear	2.06:1	Reverse	3.61:1
3rd gear	1.26:1		
Differential ratio			
4.125:1			

#### Automatic Stick Shift

Hydrodynamic torque converter with three speed synchromesh transmission, combined with final drive in one housing.  
Drive shafts with two constant velocity joints per shaft.

Gear ratios:	
Driving range 1	1.26:1
Driving range 2	0.88:1
Driving range L	2.25:1
Reverse range R	3.07:1
Differential ratio:	4.125:1

## Electrical System

### Dimensions and Weights

Voltage .....	12 volts
Battery .....	45 Ah
Starter .....	0.7 bhp; with Automatic Stick Shift 0.8 bhp.
Generator .....	max. 360 watts, early cut-in
V-belt size .....	9.5 x 900 LA "DA", 9.5 x 905 LA "DA" 9.5 x 905 LA "XDA" ("DA" = low stretch factor)
Ignition distributor .....	with combined vacuum and centrifugal spark advance
Firing order .....	1 - 4 - 3 - 2
Basic ignition timing .....	5° after TDC — engine at operating temperature at 800 to 900 rpm* (900 to 1000 rpm on cars with Automatic Stick Shift.)
Contact breaker gap .....	.016 in. (0.4 mm)
Spark plugs .....	Bosch W 145 T 1, Beru 145/14, Champion L 88 A or plugs with similar values from other manufacturers
Plug thread .....	14 mm
Electrode gap .....	.028 in. (0.7 mm)

\* Check ignition timing only with stroboscopic light, vacuum hoses attached.

	<b>Volkswagen Super Beetle</b>	<b>Volkswagen Convertible</b>	<b>Volkswagen Beetle</b>
Length .....	161.8 in. (4110 mm)	161.8 in. (4110 mm)	158.6 in. (4030 mm)
Width .....	62.4 in. (1585 mm)	62.4 in. (1585 mm)	61.0 in. (1550 mm)
Height .....	59.1 in. (1500 mm)	59.1 in. (1500 mm)	59.1 in. (1500 mm)
Ground clearance .....	5.9 in. ( 150 mm)	5.9 in. ( 150 mm)	5.9 in. ( 150 mm)
Unladen weight (ready for use) .....	1918 lbs. ( 870 kg)	2080 lbs. ( 920 kg)	1807 lbs. ( 820 kg)
Permissible load .....	822 lbs. ( 400 kg)	794 lbs. ( 360 kg)	838 lbs. ( 380 kg)
Gross vehicle weight .....	2800 lbs. (1270 kg)	2822 lbs. (1280 kg)	2645 lbs. (1200 kg)
Permissible front axle load .....	1117 lbs. ( 530 kg)	1190 lbs. ( 540 kg)	1080 lbs. ( 490 kg)
Permissible rear axle load .....	1675 lbs. ( 760 kg)	1675 lbs. ( 760 kg)	1609 lbs. ( 730 kg)
Permissible roof and trailer weights:			
Roof weights* * .....	110 lbs. ( 50 kg)	—	110 lbs. ( 50 kg)
Trailer without brakes .....	882 lbs. ( 400 kg)	882 lbs. ( 400 kg)	882 lbs. ( 400 kg)

\* \* Applies only to roof rack mounted to rain gutters. Distribute load evenly.

## Capacities

Fuel Tank — Super Beetle .....	11.1 U.S. gal. (42 liters; 9.2 Imp. gal.)
Beetle .....	10.6 U.S. gal. (40 liters; 8.8 Imp. gal.)
Engine .....	5.3 U.S. pints ( 2.5 liters; 4.4 Imp. pints)
Brake system .....	approx. .53 U.S. pints (0.25 liter; .44 Imp. pints)
Oil bath air cleaner .....	approx. .9 U.S. pints (0.4 liter; 8 Imp. pints)
Windshield washer .....	approx. 3.6 U.S. pints (approx. 1.7 liters; 3.1 Imp. pints)
Transmission and final drive .....	6.3 U.S. pints (3.0 liters; 5.3 Imp. pints)
	5.3 U.S. pints at changes ( 2.5 liters; 4.4 Imp. pints)

### *On vehicles with Automatic Stick Shift*

Torque converter circuit .. . . . approx. 7.6 U.S. pints ATF (3.6 liters; 6.3 Imp. pints)\*

\* Does not have to be changed

## Performance

	<i>Manual Transmission</i>	<i>Automatic Stick Shift</i>
Maximum and cruising speed	81 mph.	78 mph.
Acceleration time from 0-62 mph.	21 seconds	approx. 23 seconds

## General Specifications

### Volkswagen Super Beetle and Convertible

Platform frame with tunnel-shaped center member, engine/transmission unit bolted to rear frame fork.

Independent wheel suspension: At front with suspension struts incorporating shock absorbers and coil springs, attached to frame head by track control arms and stabilizer. Rear wheel suspension with trailing arms and diagonal links.

Springing: coil springs at front, torsion bar springs at rear, telescopic shock absorbers both front and rear.

Roller steering (energy absorbing) with maintenance free tie-rods and hydraulic steering damper. Hydraulic dual-circuit foot brakes, mechanical parking brake effective on rear wheels.

### Volkswagen Beetle

Platform frame with tunnel-shaped center member, front axle bolted to frame head, engine/transmission unit bolted to rear frame fork.

Independent wheel suspension: torsion arms at front, trailing arms and diagonal links at rear.

Torsion bar springing, telescopic shock absorbers, stabilizer at front.

**Volkswagen Super Beetle  
and Convertible**

**Volkswagen Beetle**

Wheelbase .....	95.3 in. (2420 mm)	94.5 in. (2400 mm)
Turning circle diameter .....	31.5 ft. 5 in. (9.6 m)	34 ft. 2.5 in. (11 m)
Track at front .....	54.1 in. (1375 mm)	51.6 in. (1310 mm)
Toe-in, unladen .....	09 to .19 in. (2.4 to 4.8 mm)	07 to .21 in. (1.8 to 5.4 mm)
Camber, unladen .....	1° +20' -40'	30' ±20'
Track at rear .....	53.2 in. (1352 mm)	53.1 in. (1350 mm)

**Wheels** ..... 4 J x 15 safety rim wheels

**Tires, tubeless** ..... Bias Ply Tires 5.60-15/load capacity 970 lbs. at 32 psi

<b>Tire pressures, cold with 1 or</b>	<b>Front</b>	<b>Rear</b>	<b>Front</b>	<b>Rear</b>
2 occupants .....	16 psi (1.1 kg/cm <sup>2</sup> )	27 psi (1.9 kg/cm <sup>2</sup> )	16 psi (1.1 kg/cm <sup>2</sup> )	24 psi (1.7 kg/cm <sup>2</sup> )
fully loaded .....	18 psi (1.3 kg/cm <sup>2</sup> )	27 psi (1.9 kg/cm <sup>2</sup> )	17 psi (1.2 kg/cm <sup>2</sup> )	26 psi (1.8 kg/cm <sup>2</sup> )

For long, high speed trips, the tire pressures should be increased by 3 psi (0.2 kg/cm<sup>2</sup>) at front and rear, but should not exceed the maximum tire inflation pressure listed on the label.

## Index

A	
Accessories .....	123
Air Cleaner	
Cleaning and Servicing .....	30
Installing .....	31
Removing .....	30
Automatic Stick Shift	
Transmission .....	28
B	
Battery	
Checking and Filling .....	36
Installing .....	38
Removing .....	37
Beauty Care	
Airing the Body .....	122
Caring for Chrome .....	121
Caring for Convertible Tops .....	122
Caring for Door and Window	
Weatherstrips .....	122
Caring for Front Seats .....	122
Caring for Windshield	
Wiper Blades .....	121
Cleaning Cloth Upholstery .....	122
Cleaning Leatherette .....	122
Cleaning Windows .....	121
Polishing .....	121
Removing Insects .....	121
Removing Tar Spots .....	121
Removing Tree Residue .....	121
Washing .....	120
Waxing .....	121
Belt, V .....	57
Brake Fluid Reservoir	
Checking Fluid Level .....	78
Bulb Replacement	
Chart .....	89
Bumper, Front .....	112
Bumper, Rear .....	113
Bumper, Rubber Molding .....	114

C	
Carburetor	
Idle Speed Adjustment .....	55
Car Care .....	120
Caring for Chrome .....	121
Caring for Convertible Tops .....	122
Caring for Door and Window	
Weatherstrips .....	122
Caring for Front Seats .....	122
Caring for Windshield	
Wiper Blades .....	121
Charts	
Bulb Replacement .....	89
Lubrication .....	20
Maintenance .....	19
Checking Engine Oil Level .....	25
Cleaner, Air	
Cleaning and Servicing .....	30
Installing .....	31
Removing .....	30
Clutch	
Adjusting Pedal Free Play .....	61
Checking Pedal Free Play .....	61
Condenser	
Installing .....	51
Removing .....	50
Contact Breaker Points, Distributor	
Adjusting .....	49
Checking .....	47
Replacing .....	48

D	
Damper, Steering (Beetle) .....	70
Damper, Steering (Super	
Beetle) .....	73
Data, Technical .....	129
Distributor, Ignition	
Installing Rotor and Cap .....	46
Removing and Inspecting Cap ...	45

Removing and Inspecting	
Rotor .....	46
Door and Hood Locks, Lubricating	
Door Lock Cylinder .....	34
Door Lock Mechanism .....	34
Hood Locks and Hinges .....	35
Dwell Angle Check and	
Adjustment .....	52

## E

Electrical Systems	
Description .....	80
Wiring Diagrams .....	85,86,87,88
Engine Oil Change	
Draining .....	22
Replacing .....	24
Engine Oil Level, Checking .....	25
Exhaust Pipes .....	69
Exhaust Muffler	
Inspection .....	65
Installation .....	66
Removal .....	63

## F

Fenders, Front .....	115
Fenders, Rear .....	117
Front Axle	
Servicing .....	33
Front Bumper	
Installing .....	112
Removing .....	112
Front Fenders	
Installing .....	116
Removing .....	115
Front Seats	
Installing .....	110
Removing .....	109
Front Turn Signal and	
Parking Light Assembly	
Installing .....	95
Removing .....	94
Front Turn Signal and Parking	
Light or Side Marker Light	
Bulb Replacement .....	94
Fuel Pump Filter	
Installing New Filter .....	60
Removing Oil Filter .....	60

Fuses	
Location .....	99
Replacing .....	100

## H

Headlight Assembly	
Adjusting .....	92
Installing .....	92
Removing .....	91
Headlights	
Installing .....	90
Removing .....	90
Heating, Rear Footwell	
Adjusting Flaps .....	110
Positioning Cables .....	111
Hood Lock and Hinge	
Lubrication .....	35

## I

Ignition Timing Procedure .....	53
Interior Light	
Bulb Replacement .....	98

## J

Jacking and Supporting	
Right Side with Both Wheels Off	
the Ground .....	15
Left Side with Both Wheels Off	
the Ground .....	16
Jacking Either Side with Support	
Stand Under Front and Rear ...	16

## L

License Plate Light	
Bulb Replacement .....	98
Light	
Bulb Chart .....	89
Lubrication Chart .....	20

## M

Muffler, Exhaust	
Inspection .....	65
Installation .....	66
Removal .....	63

## O

Oil Strainer .....	22
--------------------	----

P

Paint, Touching Up .....	121
Points, Contact Breaker	
Adjusting .....	49
Checking .....	47
Replacing .....	48
Plugs, Spark	
Adjusting .....	40
Cleaning and Inspection .....	40
Installing .....	41
Removing .....	40
Polishing Car .....	121
Preparation and Tool List .....	1
Pump Filter, Fuel	
Installing New Filter .....	60
Removing Old Filter .....	60

R

Rear Bumper	
Installing .....	113
Removing .....	113
Rear Fenders	
Installing .....	118
Removing .....	117
Rear Footwell Heating	
Adjusting Flaps .....	110
Positioning Cables .....	111
Rear Turn Signal, Stop and Tail Light, or Back-up Light	
Bulb Replacement .....	96
Rotating Wheels .....	107,108
Rubber Molding for Bumpers	
Installing .....	114
Removing .....	114
Running Board	
Installing .....	119
Removing .....	119

S

Shock Absorbers	
Checking .....	77
Installing Rear Shock Absorbers .....	77
Removing Rear Shock Absorbers .....	76
Spare Wheel Removal .....	106
Spark Plugs	
Adjusting .....	40

Cleaning and Inspection .....	40
Installing .....	41
Removing .....	40
Steering Damper (Beetle)	
Checking .....	71
Installing .....	72
Removing .....	70
Steering Damper (Super Beetle)	
Checking .....	74
Installing .....	75
Removing .....	73
Supporting, Jacking and .....	14

T

Tail Light Assembly	
Installing .....	97
Removing .....	96
Tail Pipes	
Installation .....	70
Removal .....	69
Technical Data .....	129
Throttle Valve Positioner	
Checking and Adjusting Closing Time .....	56
Checking Fast Idle .....	56
Tires	
Checking Condition .....	103
Wear .....	104
Timing, Ignition .....	53
Tool List .....	2.3
Transmission .....	25
Troubleshooting	
Engine Will Not Turn Over or Turns Over too Slowly to Start .....	4
Engine Turns Over But Will Not Start .....	5
Engine Stalls Shortly After Starting .....	9
Engine Stalls While Vehicle is Driven .....	9
Oil Pressure Warning Light Comes on While Driving .....	11
Generator and Cooling Warning Light Comes on While Driving .....	11
Automatic Stick Shift Lever Cannot be Shifted .....	11
Tune Up .....	12



V	
Valve Clearance	
Adjusting .....	42
V-Belt	
Adjusting .....	58
Checking Tension .....	57
Replacing .....	68
W	
Washing Car .....	120
Waxing Car .....	121
What Should be Done Regularly ...	18
Wheels	
Installing .....	106
Removing .....	105
Removing Spare Wheel .....	106
Rotating (Five Wheel) .....	107
Rotating (Four Wheel) .....	108
Snow Tire Procedure .....	105
Windshield Washer	
Adjusting Spray Jets .....	103
Cleaning Spray Jets .....	103
Filling .....	79
Windshield Wiper Blades	
Replacing Blades .....	101
Replacing Rubber Fillers .....	101
Wiring Diagrams .....	85/86, 87/88

# SUPER BEETLE

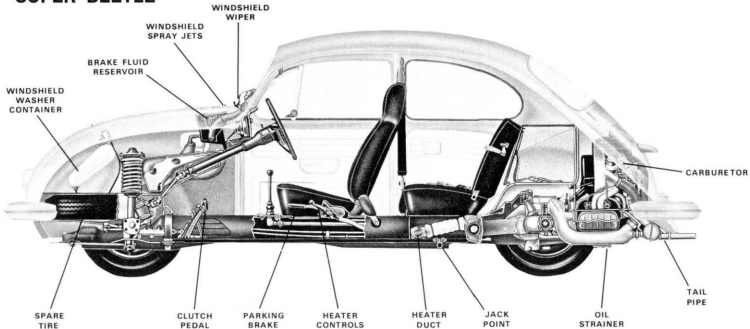

# BEETLE

