

Volkswagen Owner's Manual: Operation and Maintenance 1972 Models

Type 1

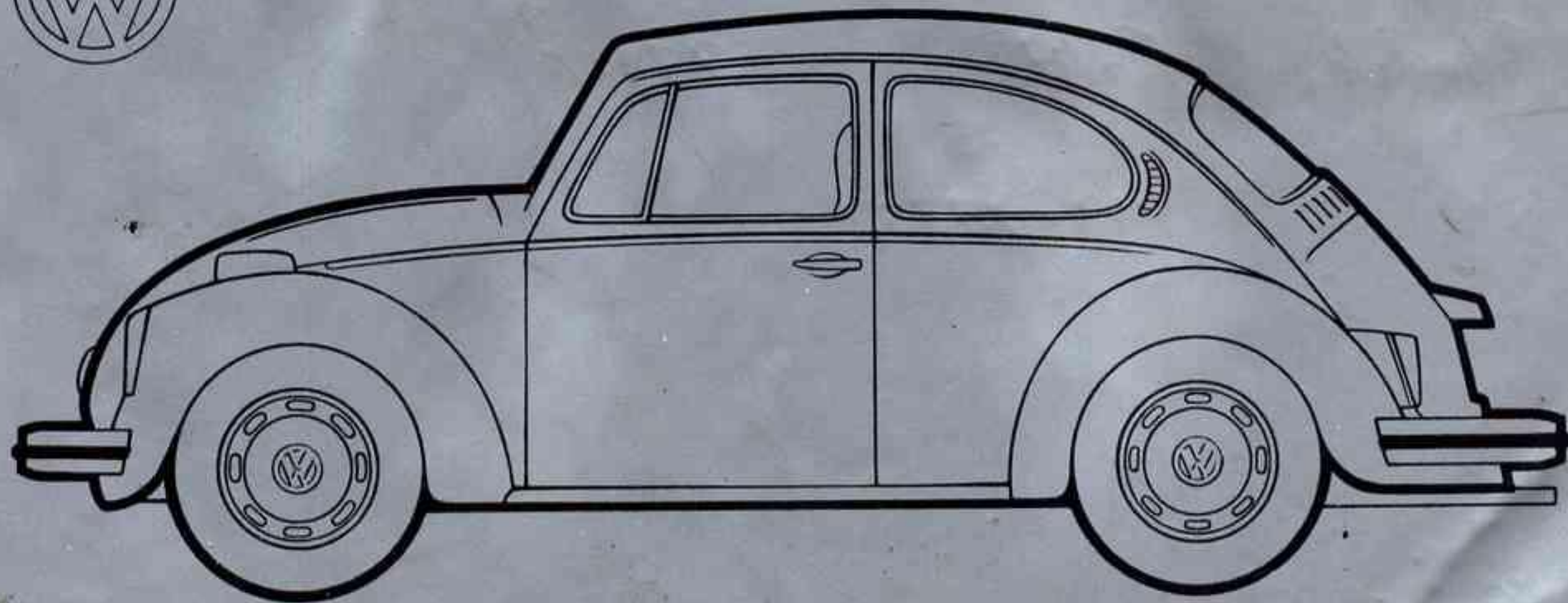

Volkswagen Owner's Manual: Operation and Maintenance

1972 Models



Volkswagen
Sedan 111



Volkswagen
Sedan 113

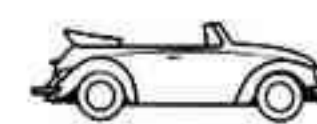

Volkswagen
Convertible

V O L K S W A G E N W E R K A K T I E N G E S E L L S C H A F T

© 1971 Volkswagenwerk Aktiengesellschaft

All rights reserved.

May not be reproduced or translated in whole or in part without the written consent of Volkswagenwerk AG.

Specification subject to alteration without notice.

561.007.23

Printed in Germany 8.71

The VOLKSWAGEN OWNER'S MANUAL consists of two major parts: operation description and Diagnosis & Maintenance record.

The first part acquaints you with your Volkswagen Warranty and the operation of your car. It also gives you information on fuel, oil and lubrication.

The second part deals with the maintenance of your Volkswagen. It explains what the VOLKSWAGEN DIAGNOSIS and MAINTENANCE is all about, and how to keep your Volkswagen in top driving condition.

Always have your Volkswagen Owner's Manual with you when you take your car to an Authorized Volkswagen Dealer for service . . . it provides your Service Adviser with the information he needs and enables him to make the necessary entries for you.

Please read this manual before you drive your new Volkswagen. Acquaint yourself with its features, and know how to operate it more safely . . . because the more you know about it, the more you will enjoy driving your Volkswagen.

Pictures and text in this manual are based on the 1972 Volkswagen Sedan 113 with Manual Transmission. Where the controls, equipment and technical data of the Volkswagen Sedan 111, the Automatic Stick Shift and the Volkswagen Convertible differ considerably, we will point this out in the text.

It has always been Volkswagen's policy to continuously make technical improvements; therefore, the right is reserved to make changes at any time during the model year without notice.

Contents

	page		page		page
Warranty	7	Manual Transmission	32	Container for windshield washer fluid	65
Dear VW Owner	13	Automatic Stick Shift	34	Brake fluid reservoir	65
Vehicle identification	15	Starting hints	36	Battery	66
Keys	16	Sun visors	37	Fuel supply	67
Doors	17	Interior light	37	Checking the engine oil level	68
Windows	18	Assist straps and coat hooks	37	Checking the ATF level	68
Seats	18	Ashtrays	38	Removing and installing seats	69
Safety belts	20	Glove compartment	38	Cleaning your VW	70
		Luggage compartments, front and rear	39	Engine oil	73
Instrument panel	22	Heater/Defroster	42	Transmission oil and Automatic Transmission Fluid	74
Ignition/steering lock	24	Ventilation	44	Volkswagen Diagnosis and Maintenance	77
Emergency flasher	24	Sliding roof	46	Test report	78
Brake warning light	25	Convertible top	46	Maintenance record	81
Headlight switch	25	Air conditioner	48	Additional service	91
Instrument illumination	25	Auxiliary heater	50	Scheduled maintenance	93
Speedometer	26	Sectional side view of the car attached to page	50	Address change cards	98
Fuel gauge	26	Towing and trailer hauling	51	Index	103
Rear window defogger	27	Winter operation	52	VW distributor addresses	106
Turn signal/headlight dimmer switch lever	28	Tires	54		
Lane changer	28	Spare wheel	58		
Windshield wiper/washer lever	29	Jack	59		
Generator warning light	30	Changing a wheel	60		
Oil pressure warning light	30				
ATF warning light	30				
Rear view mirrors	31				

Volkswagen offers a quality product. Maintain this quality by having your Volkswagen serviced regularly. A service schedule that we recommend is explained in the section Volkswagen Diagnosis and Maintenance.

Should you have occasion to make use of your Volkswagen Warranty, it is always helpful to have the related service receipts handy.

WARRANTY VOUCHER

for the new VW automobile

Type: 1131 Super Beetle 2dr Sdn

Chassis No. 112237717

Engine No. AE 724842

In accordance with the terms of warranty printed overleaf.

The warranty commences at the date the VW automobile is delivered to the original purchaser,

viz. on 24 March, 1972
(To be filled in by selling VW Dealer)

and covers a period of 24 months or the period before the vehicle has been driven 24,000 miles, whichever event shall first occur. Should any warranty claim arise, you are requested to present this voucher to your VW Dealer.

VOLKSWAGEN OF AMERICA, INC.



Air Conditioner Installation	Auxiliary Heater Installation	Speedometer Replacement
<p>Date: _____</p> <p>At Mileage: _____</p> <p>(Stamp of Installing VW Dealer)</p> <p>Make, Model: _____</p>	<p>Date: _____</p> <p>At Mileage: _____</p> <p>(Stamp of Installing VW Dealer)</p> <p>Make, Model: _____</p>	<p>Date: _____</p> <p>At Mileage: _____</p> <p>(Stamp of Replacing VW Dealer)</p> <p>Make, Model: _____</p>

No express warranties, as to Volkswagen vehicles sold in the United States are made either by Volkswagen of America, Inc. ("VWoA"), or by the manufacturer, the distributor or the selling dealer, except the following warranty by Volkswagen of America, Inc.

Warranty for New Volkswagen Vehicles

This warranty is issued by Volkswagen of America, Inc. ("VWoA"), the authorized United States importer of Volkswagen vehicles.

Free repair or replacement in the United States and Canada of defective parts for 24 months or 24,00 miles

1. VWoA warrants that every Volkswagen vehicle imported by VWoA and sold as a new vehicle to a retail customer by an authorized United States Volkswagen dealer will be free from defects in material and workmanship under normal use and service for 24 months after the date of delivery of the vehicle to the the original retail customer or until the vehicle has been driven 24,000 miles, whichever comes first. This warranty is limited, however, to the following: If any part of the vehicle becomes defective under normal use and service and the vehicle is brought during this period to the workshop of any authorized Volkswagen dealer in the continental United States, Hawaii or Canada, the dealer will, without charge, either repair the defective part or replace it with a new or factory reconditioned part.

Maintenance required to keep warranty in effect

2. In order to keep this warranty in effect, the owner must have the vehicle maintained and serviced as prescribed in the Volkswagen Maintenance Schedule.

Items not covered by warranty

3. VWoA's warranty does not cover:
(i) Defects, damage or deterioration due to normal use, wear and tear or exposure;
(ii) normal maintenance services, such as fuel system cleaning and wheel, brake or clutch adjustments; (iii) the replacement of service items, as, for instance, spark plugs, ignition points, wiper blades or brake linings; (iv) deterioration of upholstery, soft trim and appearance items; (v) damage or defects due to misuse, alteration, negligence or accident; (vi) damage or defects due to the repair of the vehicle by someone other than an authorized Volkswagen dealer or the installation of parts other than genuine Volkswagen parts; (vii) damage or defects due to the

**Warranty
outside the
United States
and Canada**

use of the vehicle in competitive events, including rallies and races; (viii) and loss of time, inconvenience, loss of use of the vehicle or other consequential damage.

4. If the vehicle is brought to an authorized Volkswagen workshop outside the continental United States, Hawaii or Canada, VWoA's warranty will not be applicable and defective parts will be repaired or replaced free of charge with new or factory reconditioned parts only within the terms and limitations of the warranty for new Volkswagen vehicles in effect in the country where such authorized Volkswagen workshop is located.

**No other
warranties made**

5. This warranty is in lieu of all other express warranties of VWoA, the manufacturer, the distributor and the selling dealer. Neither VWoA nor the manufacturer assumes, or authorizes any person to assume, on its behalf, any other obligation or liability.

Let us explain the warranty . . .

Volkswagen of America, Inc. is proud of the quality of the automobiles it imports. It warrants new vehicles for a period of 2 years or 24,000 miles from the date of purchase, whichever comes first. In general, the complete vehicle including battery and tires is covered under the provisions of the Volkswagen New Vehicle Warranty. It will be honored by any Authorized Volkswagen Dealer in all 50 States, the District of Columbia and Canada.

This warranty is transferable if the ownership of the vehicle changes within the above period.

In order to keep the warranty in force, you, as the owner of the vehicle, have certain responsibilities. It is important that the vehicle be maintained properly. To facilitate record keeping, this booklet provides space for listing diagnosis, maintenance, and oil change services as they are performed.

Diagnosis and maintenance services should be performed by Authorized Volkswagen dealers. They have Volkswagen trained mechanics and special tools to provide fast, efficient service in accordance with Volkswagen quality standards.

The terms of your warranty require you to keep a maintenance record of your vehicle. Provided that maintenance or oil change services were performed in accordance with Volkswagen specifications, dated bills of other than Authorized Volkswagen dealers will be accepted as proof that these services were performed when required.

Not all repairs, adjustments and replacements, however, are the result of defects in material or workmanship. There are other circumstances beyond the control of the manufacturer that might make a workshop visit necessary. These depend mainly on where you drive and how you drive. They would include weather and atmospheric conditions, varying road surfaces, individual driving habits and vehicle usage.

For example, you are required to pay for the following:

Maintenance services and oil changes.

Diagnosis services – except those diagnosis services for which a free coupon is presented at specified mileage intervals.

Wheel alignment and wheel balancing. The frequency of these services depends on driving conditions such as rapid starts and stops, tire skidding, hitting pot holes and curbs, etc.

Mechanical adjustments – including brakes, clutch, door locks – are required as a matter of normal operation of a motor vehicle. This protects you against early or expensive replacements.

Brakes and clutch linings are directly affected by driving habits and use. The replacement of brake linings, brake pads, clutch linings and shock absorbers, and the reconditioning of brake drums and brake discs should be performed whenever necessary.

Spark plugs and ignition points are subject to wear. Periodic replacements ensure you of maximum engine performance and gasoline economy.

Wiper blades will have a varied life expectancy, depending on climatic conditions and extent of use. You are the best judge of when they should be replaced.

Light bulbs and fuses are service items.

Paint, chrome, convertible top, trim and other appearance items are affected by normal wear and exposure. Proper care of these items can add to their appearance and durability. (Imperfections are normally apparent during New Vehicle Pre-Delivery Inspection. For your protection, please report any imperfection to your dealer immediately.)

Tires and battery are subject to wear. If there is a defect, you pay only for the amount of use you obtained. An adjustment for tires is based on the remaining tread depth. Battery adjustment is according to time used, based on 24 months of service. This is known as the pro-rata method of adjustment.

Volkswagen parts, accessories and exchange units are identified by these trademarks.

All meet the same exacting quality control standards as the original equipment on the car, and comply with all applicable Government safety regulations.

They are guaranteed to be free from defects in material or workmanship for a period of 6 months or 6,000 miles, whichever comes first.

All Volkswagen parts and accessories are available at your Authorized Volkswagen Dealer.

Also, ask him about rebuilt parts under the Volkswagen Exchange Service . . . they cost less than new parts but carry the same warranty.



Dear VW Owner:

A lot has gone into the manufacture of your Volkswagen. Including advanced engineering techniques, rigid quality controls and demanding inspections. The engineering and safety features that have gone into your VW will be enhanced by . . . you,

the safe driver

- who knows his vehicle and all the controls,
- who maintains his vehicle properly,
- who uses his driving skills wisely.

Because safe driving is important to you, we urge you to read this manual carefully, to maintain your VW properly and to follow the check list shown below whenever you use your VW.

Before getting behind the wheel:

- 1 - Make sure that the tires are inflated correctly.
- 2 - Watch the tread depth indicator on the tires. Look for bruises and wear.
- 3 - See that all windows are clean and unobstructed.
- 4 - Check that headlight and tail light lenses are clean.
- 5 - Check that all lights are functioning properly.
- 6 - Check turn signal lamps and indicator light (ignition on).

In the driver's seat:

- 1 - Position seat properly for easy reach of controls.
- 2 - Adjust inside and outside mirrors for unobstructed rear view.
- 3 - Fasten safety belts.
- 4 - Check brake warning light (ignition on).
- 5 - Check brake operation.
- 6 - Make sure that all doors are closed securely and locked.

And when you are on the highway:

- 1 - Always drive defensively. Expect the unexpected.
- 2 - Use signals to indicate turns and lane changes.
- 3 - Turn on headlights at dusk.
- 4 - Follow at a safe distance. A good rule of thumb is to allow a minimum of one car length for each 10 mph of speed.
- 5 - Reduce speed during night hours and inclement weather.
- 6 - Observe speed limits and obey highway signs.
- 7 - When tired, get off the highway, stop and take a rest.
- 8 - When stopped or parked, always set the parking brake.
- 9 - When stalled or stopped for repairs, move the car well off the road. Set the emergency flasher and use road flares or other warning devices to warn other motorists.

MANUFACTURED BY **VOLKSWAGENWERK AG**
THIS VEHICLE CONFORMS TO ALL APPLICABLE FEDERAL MOTOR
VEHICLE SAFETY STANDARDS IN EFFECT ON THE DATE OF MANU-
FACTURE SHOWN ABOVE.

0877

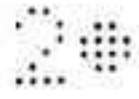
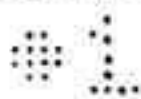

This sticker is your assurance that your 1972 Volkswagen complies with all U.S. Federal Motor Vehicle Safety Standards which were in effect at the time the vehicle was manufactured. You can find this sticker on the left doorjamb.

The sticker also shows the month and year of production as well as the chassis number of your car (perforation).

Vehicle Identification



The identification plate

is the "birth certificate" of your Volkswagen. It is located under the front hood next to the hood lock.

On the Volkswagen Sedan 111, the plate can be found in the spare wheel well.

The plate shows such information as manufacturer's name, place of origin, model, weights and "Fahrgest.-Nr.", which is the chassis number of your car.



The chassis number

is also located on the instrument panel on the driver's side so that it is visible from the outside through the windshield. This is for your protection ... to aid in the apprehension of car thieves and the recovery of stolen vehicles.



The chassis number is also stamped on the frame tunnel under the rear seat.

The engine number

is stamped on the generator support flange.

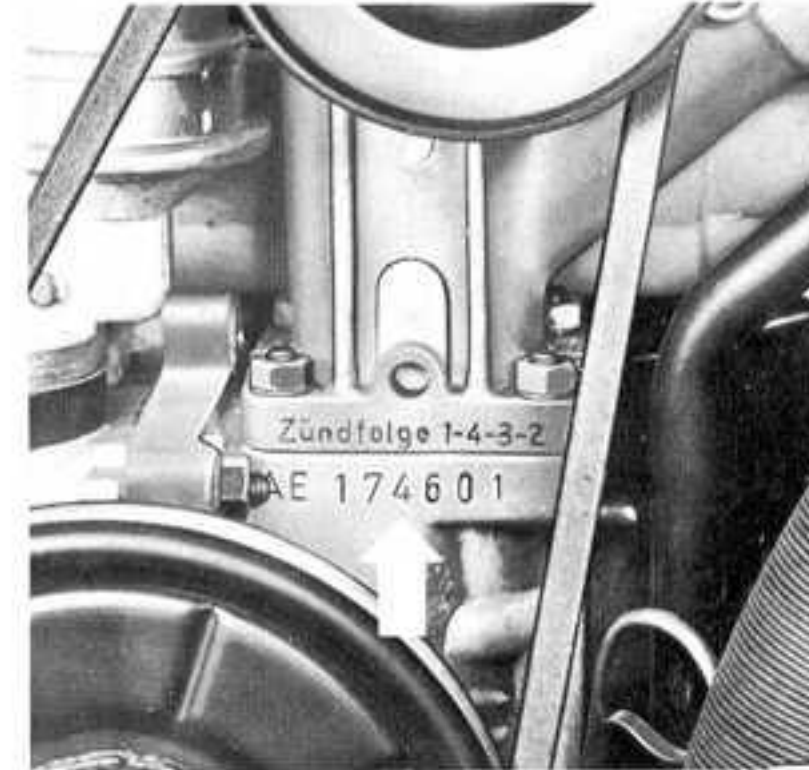

Keys



Your Volkswagen comes with two sets of keys:

The key with the elongated head is for the doors and the ignition/steering lock.



The key with the round head is for the glove compartment only. The glove compartment of the VW Sedan 111 does not have a lock.

Do not invite car theft

by leaving your car unattended with the key in the ignition lock. Take the key with you and lock the doors.

A buzzer will remind you when you open the driver's door and the key is still in the ignition lock.

It is a good idea to keep a record of your key numbers in your wallet together with your license. If you should lose a key, your Authorized VW Dealer will thus be able to quickly secure a replacement key for you.

To locate the key number of the ignition key, slide the cover off the head.

Doors

Always drive with locked doors to prevent inadvertent opening of a door from the inside, especially with smaller children in the car.

Since your Volkswagen is almost air tight it will be easier to close the door if you open a window slightly.

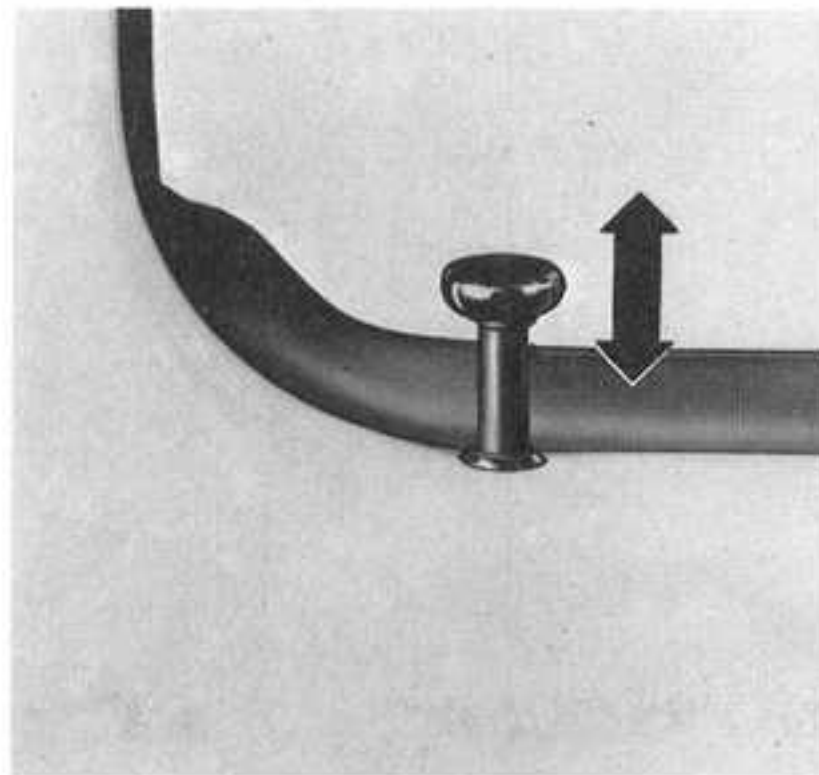

To lock and unlock doors from the outside

You can lock and unlock your car with a key, of course.

But you can also lock it without a key.

First push in the inside locking knob on the upper door panel. Then depress the plunger in the outside door handle as you close the door.

On the VW Convertible depress the locking lever in the inside door handle.

If the door, with the locking knob or locking lever depressed, closes by itself, the locking device will disengage automatically. We provided this additional safety feature so you won't be locked out if the door should slam shut while the key is still inside the car.

To lock and unlock doors from the inside –

depress or pull out the locking device.

The locking lever on the VW Convertible looks like this:



Windows

We recommend you do not put decals or other signs on the windows of your car that interfere with the driver's vision.

We have made the windshield and windows large for clear, unobstructed visibility.

You can lower and raise the windows in the front doors by means of winders. We cushioned the knobs for your safety.

To open the vent window, turn knob into driving direction, move locking lever forward and push out window.



Seats

We recommend you do not adjust the driver's seat while driving. Your seat may suddenly jerk forward or backward, which could result in loss of control.

Your Volkswagen has adjustable front seats with built-in headrests.

To move the seat forward and backward pull the lever at the front right-hand side of the seat. Now slide the seat to the desired position. Let the lever go, and move the seat slightly back and forth to make sure it is securely engaged.



You can adjust the backrest to four different angles.

Push the backrest slightly forward to take the weight off; then turn the lever on the outboard side of the seat.

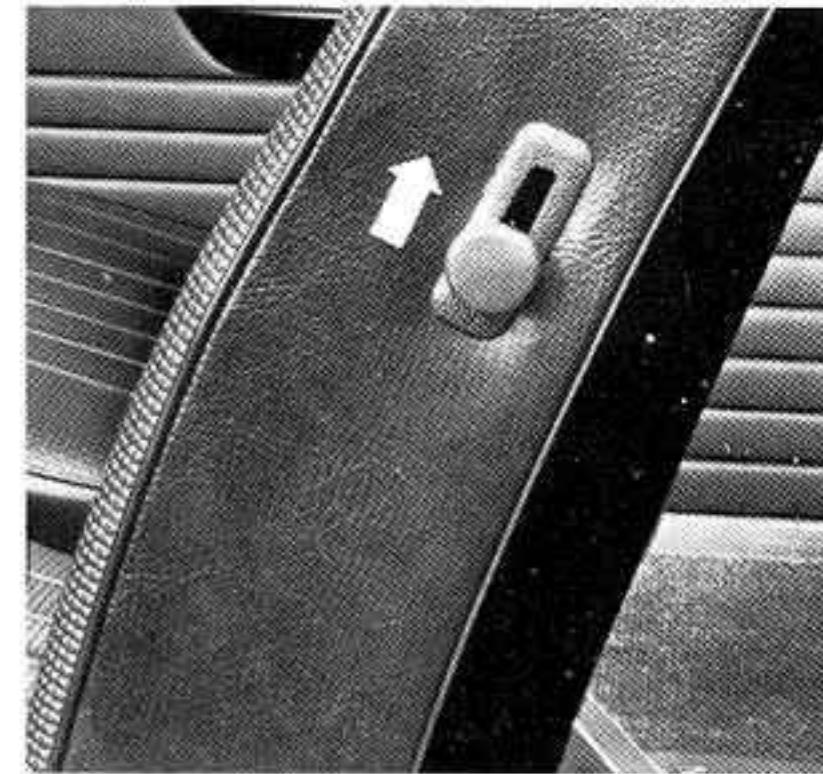

We have installed a lock on the side of the backrest.

You can disengage this lock by pulling up the lever. Tilt the backrest forward and out of the way for easy access to the rear passenger compartment.

Safety belts

A safety belt is provided for each seating position in your Volkswagen. For your protection, **fasten your safety belt before driving off and wear it at all times while the car is in motion.**

Store safety belts of unoccupied seats properly. This reduces the possibility of their becoming a striking object in case of a sudden stop.

A shoulder belt should not be worn by a person less than 4'7" in height because it would not be in its most protective position, and therefore may increase the possibility of injury in a collision.

Do not strap in more than one person in each belt.

Safety belts for front seats

The **front seats** are equipped with **combination lap/shoulder belts**. For easy storage a hook is provided on the door post.

To fasten your combination lap/shoulder belt, grasp the belt tongue, take it off the hook on the door post and pull the belt across your chest and lap. Insert the belt into the anchor housing on the center tunnel and press until it is **securely locked**.

Belts should not be worn loose or twisted. They should fit snugly across your body. The lap belt section should be completely unrolled from the retractor.

To adjust the length of the belts, press in the release on the buckle (arrow) as you pull the respective belt section in the desired direction. With this release it is also possible to adjust the belt length with the buckle already engaged in the anchor housing. Take up any slack of the loose belt by moving the slide on the belt.

To release the belt, pull the lever with the white top on the anchor housing upward.

When not in use the belt should be hung on the hook provided for this purpose on the door post.



Safety belts for rear seats

The rear seats are equipped with adjustable lap belts.

Pull the longer section across your lap and insert the tongue in the inboard buckle. Press until you hear a click to be sure the belt is locked securely.

The belt should not be worn loose or twisted.

To **release** the belt, pull the lever (white top) on the buckle.

To **lengthen** or **shorten** the rear belt, hold the belt tongue at a right angle to the belt and pull the respective belt section in the desired direction. Take up any slack of the loose belt end by moving the slide on the belt.

Keep safety belts clean. If cleaning is necessary, wash them with a mild soap solution, without removing them from the car.

Do not bleach or dye safety belts. Do not use any other cleaning agents. They may weaken the webbing.

Check buckles and retractors for proper function. Check belt webbing and bindings for damage.



The belts should always be kept on top of the seat for ready use. Do not permit them to get caught under the seat.

Instrumental panel

The padded instrumental panel and steering wheel are attractively styled for maximum safety and driving ease.

The various controls, gauges and warning lights are conveniently arranged and marked with readily recognizable symbols.

A padded grabhandle above the glove compartment lid is provided for easier passenger entrance and exit.

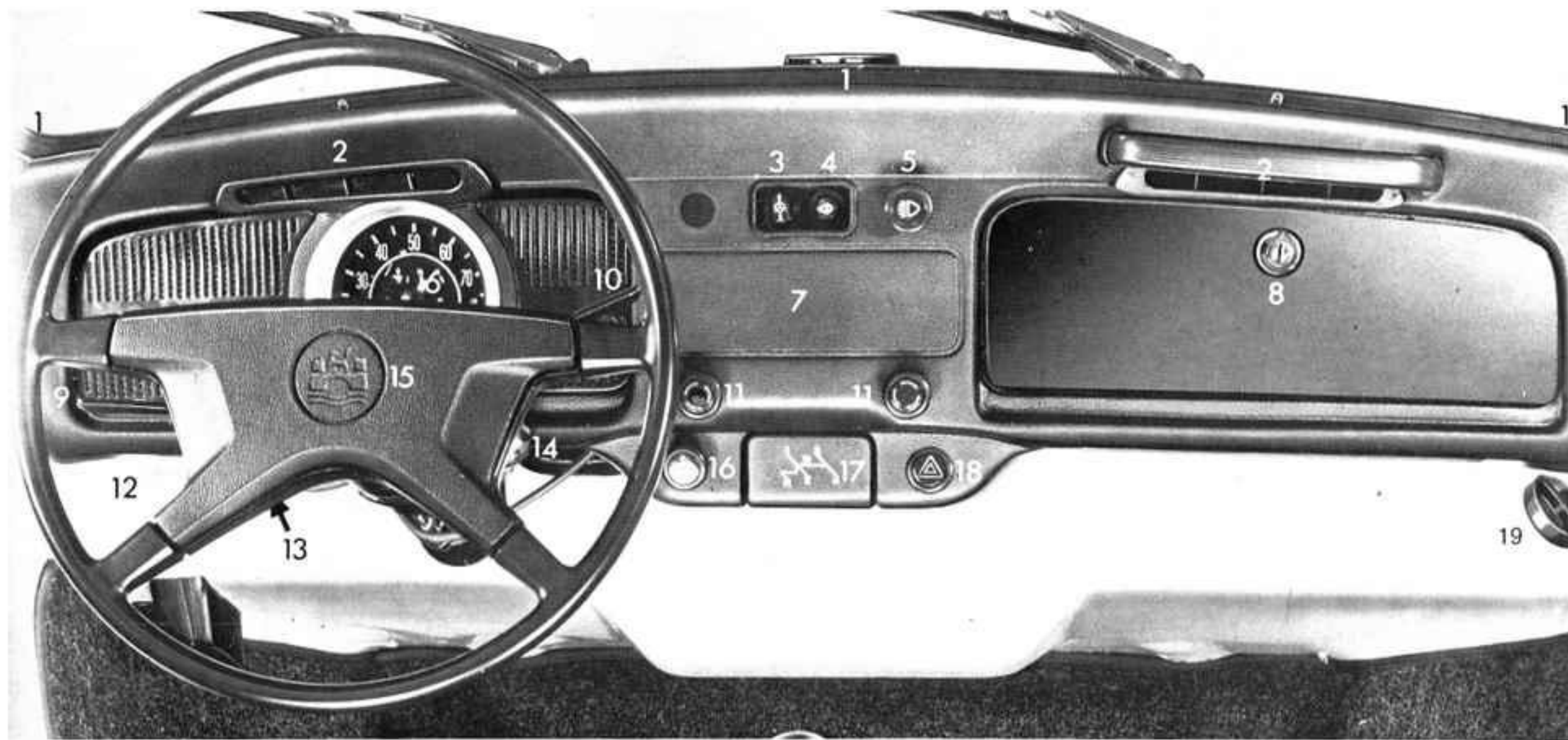

	page
1 – Vents for heating and defrosting (there are 3)	42
2 – Vents for fresh air ventilation (there is a pair on each side)	44
3 – Knob for fresh air fan (optional equipment on VW Sedan 111)	44
4 – Brake warning light	25
5 – Headlight switch	25
6 – Speedometer dial with fuel gauge and warning lights	26
7 – Plate over radio aperture	
8 – Glove compartment, lockable (except VW Sedan 111)	38
9 – Turn signal and headlight dimmer switch lever	28
10 – Windshield wiper/washer lever	28
11 – Fresh air control knobs (2)	44
12 – Fuse box	
13 – Switch for rear window defogger (VW Sedan 113 only)	27
14 – Ignition/steering lock	24
15 – Horn	
16 – Control knob for Auxiliary Heater (optional equipment)	50
17 – Ashtray	38
18 – Emergency flasher switch	24
19 – Release for fuel tank flap	67

Ignition/steering lock

The steering is equipped with an anti-theft ignition lock.

Fasten safety belts. Make sure the gearshift lever is in Neutral before turning the ignition key.

1 – Ignition off/steering locked.

Insert the key. If it is difficult to turn the key, gently move the steering wheel until the key turns freely.

2 – Ignition on/steering free (for towing).

3 – Starter engages.

The key returns to position 2 as soon as it is released. Never operate the starter longer than a few seconds. If the engine should fail to start, turn the key back to position 1 and repeat the starting procedure. More on starting on page 36.

The steering column will lock when you remove the key. Therefore **DO NOT REMOVE** the key while you are driving or as the car is rolling to a stop.

To remove the key and to lock the steering, turn the key back to position 1 and pull it out. Turn the steering wheel until it locks.

If you leave the key in the ignition/steering lock, the buzzer will sound when the driver's door is opened. This is your reminder to remove the key.



Emergency flasher switch

If your car is disabled or parked under emergency conditions, pull the switch to make all four turn signals flash simultaneously. The warning light in the switch knob flashes, too.

Move the car well off the roadway when stalled or stopped for repairs.

Brake warning light



Your Volkswagen is equipped with a dual circuit brake system. Both circuits, one for the front brakes and one for the rear brakes, can function independently.

If the brake warning light lights up when you apply the brakes while driving, one of the two brake circuits may have failed.

The other brake circuit will still operate, but a longer distance and greater pedal pressure are required to bring the car to a halt.

Pull off the road and stop.

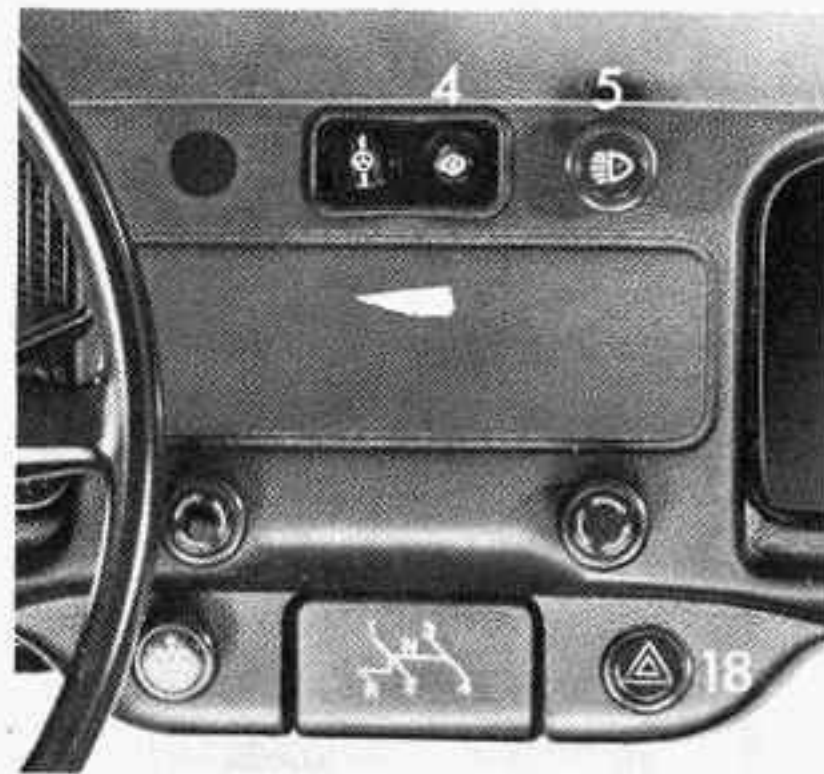

Try out the effectiveness of the brakes by carefully starting and stopping on the road shoulder.

If you judge that the brakes operate safely enough to take you to the nearest dealer, proceed cautiously and at low speed. If you do not feel safe to continue, have your car towed to the nearest dealer for repair.

Proper functioning of brake warning light

The brake warning light will light up when the ignition is turned on. It will go out after the engine has been started. This is your assurance that the brake warning system functions properly.

If the brake warning light does not light up when turning on the ignition, or if it does not go out after starting, there may be a defect in the electrical system. If this is the case, contact your Authorized VW Dealer.

Headlight switch



Pull the knob to the first stop to turn on the parking lights, the side marker lights, the license plate, tail and instrument lights.

Pull the knob to the second stop to turn on the headlights. The headlights only work with the ignition on.

To preserve the battery, the headlights will go out automatically when the ignition is turned off or when the engine is started.





Instrument illumination

You can adjust the brightness of the instrument lights by turning the light switch knob.

Speedometer dial

The speedometer indicates the speed; the odometer records the miles driven. The last digit in red indicates 1/10 of a mile.

The following warning lights are in the speedometer dial:

- a – green  rear window defogger (VW Sedan 113 only)
- b – red  generator
- c – green  turn signals
- d – blue  high beam
- e – red **ATF** Automatic Transmission Fluid temperature – Automatic Stick Shift only
- f – red **OIL** oil pressure

Fuel gauge

It is located in the speedometer dial, and only indicates the fuel level when the ignition is turned on.

When the needle is on "R" there is a reserve of about 1 gallon of fuel left in your tank . . . time to refuel at the next gas station.



Rear window defogger

(VW Sedan 113 only)

The rear window defogger – together with the flow-through ventilation – will help to keep the inside of the rear window clear of condensation and frost in the winter.

Turn the ignition on first before you switch on the rear window defogger.

The rocker switch for the rear window defogger is located under the dashboard to the left of the steering column.

The green control lamp in the speedometer dial will light up to remind you that the defogger is switched on.

To give you full battery power while starting the engine, operating rear window defogger will turn off automatically at this moment.

After the rear window has been cleared, switch off the rear window defogger to avoid an unnecessary drain on the battery.

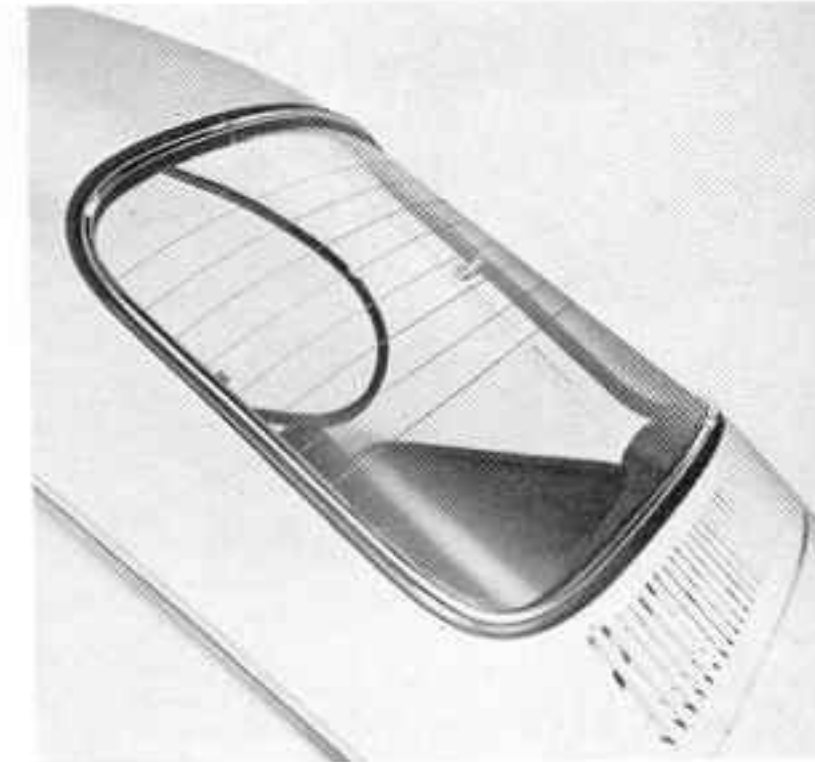
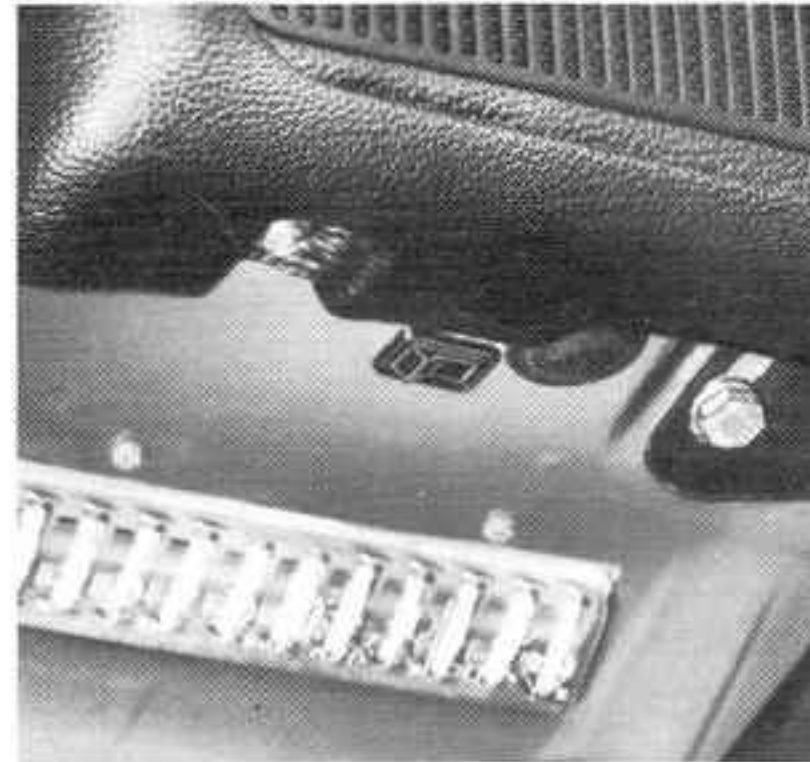

Be careful when removing objects from the luggage compartment behind the rear seat. Sharp edges may damage the defogger in the rear window.

Turn signal/headlight dimmer switch lever and windshield wiper/washer lever

There are two levers just behind the steering wheel:

The lever on the left side is for the turn signal/headlight dimmer switch.

The lever on the right side is for the windshield wiper/washer system.

The turn signals and the windshield wipers only work with the ignition on.

Turn signals



Lever up – right turn signal

Lever down – left turn signal

The green turn signal indicator light comes on in the speedometer dial when you operate the lever.

The turn signals are cancelled automatically when you have completed a turn (like driving around a corner), and the steering wheel returns to the straight-ahead position.

If a turn signal is defective, the control light flashes at about twice the normal frequency. Have your Authorized VW Dealer check and repair it for you.

Lane changer

To indicate your intention when changing lanes on expressways, slightly lift or depress the lever to an intermediate position. The lever will return to the OFF position when released.

Headlight dimmer



Dim the headlights by pulling the lever toward the steering wheel. The blue indicator light in the speedometer dial will light up when the high beams are on.



Windshield wipers



The windshield wiping system operates at two speeds: low and high.

Lifting lever to first stop – low speed

Lifting lever to second stop – high speed

If you just slightly lift the lever before reaching the first stop, the wipers will wipe as long as the lever is held in this position and come to a stop when released.

To give you full battery power while starting the engine, operating windshield wipers will stop automatically at this moment.

Windshield washer

To spray washer fluid on the windshield, pull the lever toward the steering wheel. You can operate the washer from any selected wiping position.

Avoid running the wiper blades on a dry windshield ... you may scratch the glass. Spray washer fluid on it first.

The red warning lights for **generator** and **oil pressure** in the speedometer dial will light up when the ignition is turned on. They should go out after you have started the engine.

b – Generator warning light
Stop at once . . .



if the generator warning light comes on while you are driving.

Check first whether the V-belt is slipping or broken. The V-belt does not only drive the generator but also the fan that cools the engine.

Tighten or replace the belt.



e – Automatic Transmission Fluid ATF
Stop at once . . .

if the red warning light for the ATF comes on (Automatic Stick Shift only). It indicates that the Automatic Transmission Fluid may have reached too high a temperature. This may be caused by stop-and-go traffic, mountain driving, trailer hauling, etc.

Stop the engine and check the ATF level. If it is not as required, do **not** continue driving. Contact your nearest Authorized VW Dealer.

If you have enough ATF, you may continue driving, **but only in a lower driving range**. The ATF warning light should go out after a while when the ATF has sufficiently cooled down.

If the ATF warning light has come on while driving in **Low range**, stop the engine to permit the ATF to cool down. You may continue driving after the ATF warning light has gone out.

f – Oil pressure warning light OIL
Stop at once . . .

if the oil pressure warning light comes on while you are driving.

Check the oil level to make sure you have enough oil. If the cause is somewhere else, do not drive on but contact your nearest Authorized VW Dealer.

An occasional flickering of the oil pressure warning light when the engine is idling after a long high-speed trip is no cause for concern if the light goes out upon acceleration.

Whenever stalled or stopped for repair, move the car well off the road. Turn on the emergency flasher and mark the car with road flares or other warning devices. Before working on any part in the engine compartment, wait until the engine has sufficiently cooled down.

Rear view mirrors

Adjust the outside and inside mirrors before driving off. It is important for safe driving that you have good vision to the rear.

Outside mirror

The outside mirror is hinged and folds flat against the car when struck from either direction.

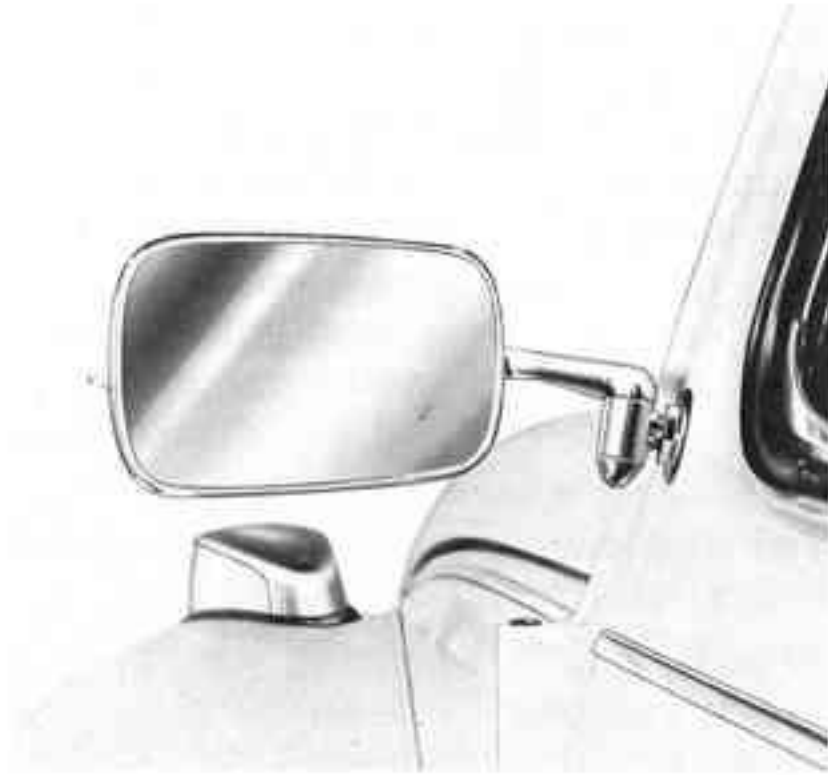

Inside day-night mirror (except VW 111)

You can move the day-night mirror from clear daylight visibility to non-glare visibility at night by adjusting the lever upward or downward at the bottom of the mirror.



On the VW Convertible, the inside mirror can be moved up by turning it 180° for better visibility when the convertible top is down. This mirror can also be adjusted for day and night driving.

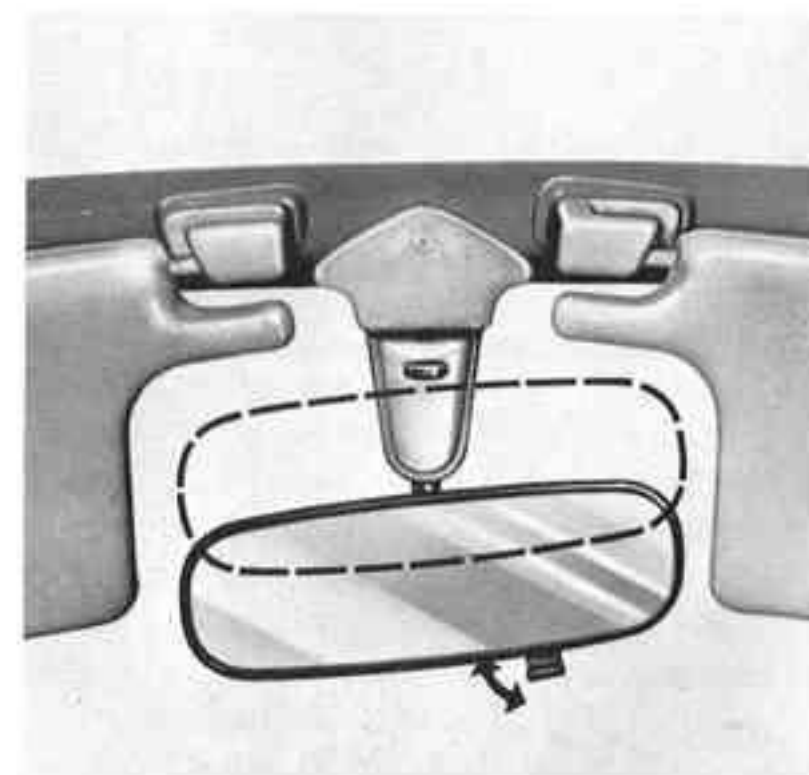

Controls for Manual Transmission

1 – Clutch pedal

Always depress the clutch pedal fully when changing gears. Do not hold the car on a steep hill with the clutch pedal partially depressed. This may cause premature wear or damage.



2 – Brake pedal

Make it a habit to check the operation of your brakes. You will remember from page 25 that the brake warning light will alert you if one brake circuit may have failed.

Make sure that the movement of the brake pedal is not obstructed by a floor mat or any other object.

Volkswagen automobiles have excellent brakes, but they are still subject to wear ... depending on how the brakes are used. If you find that the brake pedal travel has increased, have the brakes adjusted; if necessary, between the specified maintenance intervals.

Keep in mind that the braking distance increases very rapidly as the speed increases. At 60 mph, for example, it is not twice but four times longer than at 30 mph. Tire traction is also less effective when the roads are wet and slippery. Therefore, always maintain safe distance.

Driving through deep water may reduce tire traction. Moisture on the brakes may also affect braking efficiency. Cautiously apply the brakes for a test. If you notice

a lag in the braking action, the brakes may be wet. They will dry after you have applied the brakes a few times, but do it very cautiously.

Brake linings may not have the highest possible braking efficiency when new. Therefore allow for longer braking distance during the initial 100 to 150 miles. This also applies when brake shoes are renewed.

3 – Accelerator pedal

Your Volkswagen will drive about 26 miles per gallon. But keep in mind that this depends on where and how the car is used. Very fast, racy driving, alternating between full throttle and hard braking, raises the fuel consumption considerably. Also, tires and brake linings wear faster. It is more economical to drive smoothly and at a fairly constant speed.

You can drive most economically between:

- 12 and 28 mph in 2nd gear
- 22 and 44 mph in 3rd gear
- 31 and 62 mph in 4th gear

4 – Gearshift lever

Your Volkswagen has a fully synchronized transmission. The four forward gears and a reverse gear are arranged as illustrated. The shift pattern is also shown on the face of the ashtray under the dashboard.

Resting your hand on the shift lever knob while driving will cause premature wear to the transmission.

Speed ranges

You can drive your Volkswagen at full speed from the first day. You do not have a break-in schedule. There are, however, certain recommended speed ranges for the various gears:

1st gear	0–16 mph
2nd	12–34 mph
3rd gear	22–56 mph
4th gear	from 31 mph up

If you have a traffic situation where it is necessary for you to overtake rapidly, you can accelerate, for a brief period only, up to

37 mph in 2nd gear
62 mph in 3rd gear

Reverse

Only shift into Reverse when the car is not moving. To engage the reverse gear, press the lever down, move it to the left and pull back.

The back-up lights go on automatically when you engage the reverse gear (with the ignition on).

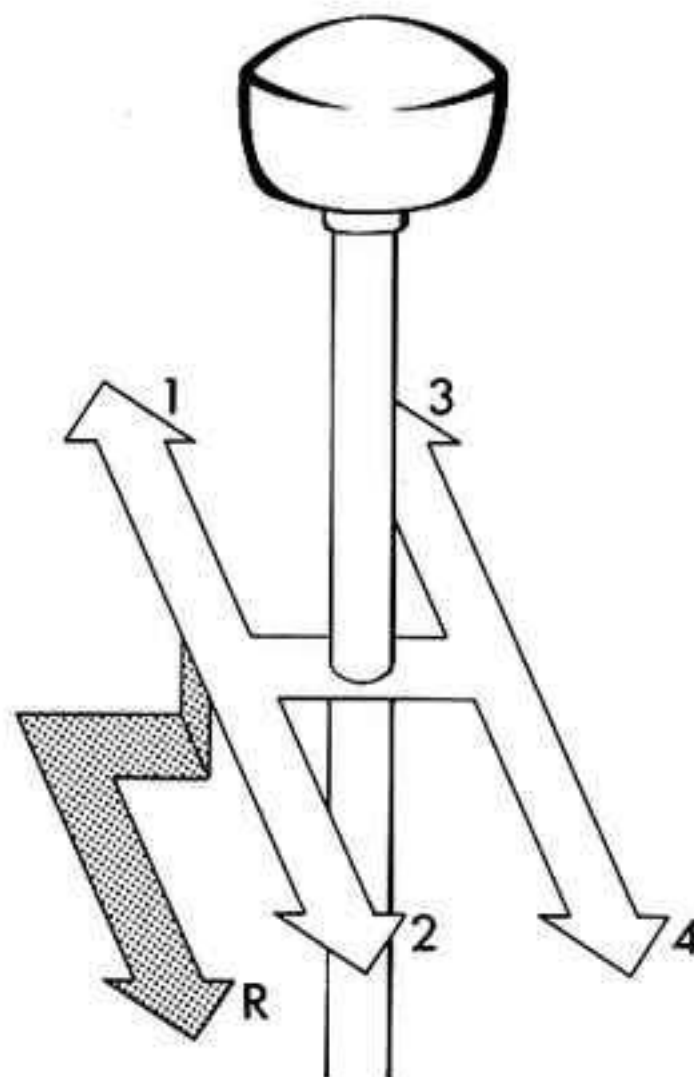

5 – Parking brake lever

To set the parking brake, press in the release button at the end of the lever as you pull up the lever. The parking brake is engaged as soon as you release the button on the raised lever.

To release the parking brake, pull the



lever slightly up as you depress the release button. Then push the lever all the way down.

Be sure it is fully released. A partially engaged parking brake promotes wear of the brake lining.

Do not remove the key from the steering lock while the car is rolling to a stop. The steering column is locked as soon as you remove the key. Take out the key only after the car is parked.

Always set the parking brake when parking your car. On steep hills also turn the wheels toward the curb.

VW Automatic Stick Shift

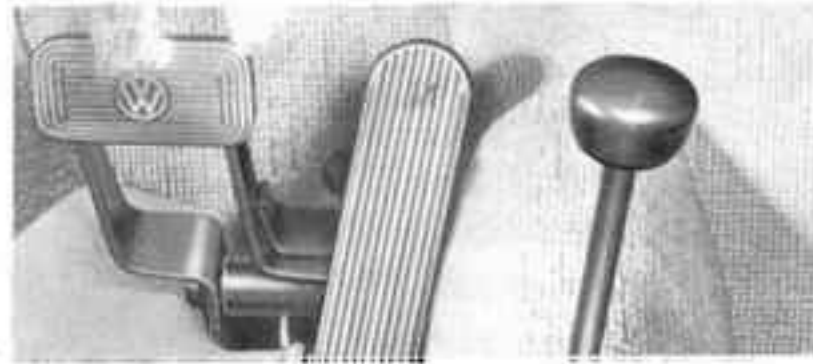

At first glance

you will notice the lack of a clutch pedal. Driving with the Automatic Stick Shift is simpler and shifting is easier. We suggest you carefully read the following instructions to familiarize yourself with the operation of the transmission.

The Automatic Stick Shift

transmission consists of a torque converter, a power-operated clutch for shifting, and a mechanical three speed transmission. The torque converter multiplies the torque produced by the engine and allows the vehicle to be driven with very little shifting – usually two driving ranges will be used. It automatically changes the torque from the engine in an infinitely variable ratio according to driving conditions. Since the torque converter is a fluid coupling, it also permits stopping the vehicle with an engaged gear while the engine is running. The clutch interrupts the flow of power from the engine to permit the gears in the transmission to be shifted. Because the power-operated clutch is actuated by the first slight movement of the gearshift lever, there is no need for a clutch pedal.

Driving ranges

With the lever mounted on the frame tunnel you can select three forward drive ranges and one reverse. The neutral position "N" is between all gears in the H-pattern.

Neutral

Neutral is the only range in which you can start the engine. In this position, the power flow to the rear wheels is interrupted. It should be used when the car is standing at idle, with the parking brake engaged.

From the Neutral position you select the desired drive range.

Driving Range 1

is for starting off and accelerating. It covers the speed range from 0–53 mph. Use this range first before shifting into Range 2. Range 1 is also recommended for use in city traffic, slow moving lines of vehicles, and whenever maximum acceleration is required for passing. If the lever is in Range 2, you may downshift into Range 1 at any speed under 53 mph.

Driving Range 2

is the range that should normally be used for highway driving. While this range may be used at any speed from 0–top speed, it is the only range that can be used above 53 mph. At low speeds, however, it is better to use Range 1 to take advantage of its better acceleration.

Low Range

Shift into Low when you want to get the car moving up steep hills, especially when carrying a heavy load or when towing, and when driving down a steep hill or parking in tight spaces.

Reverse

Engage the reverse gear **only** when the car is not moving. Depress the selector lever first to overcome a safety catch before shifting into Reverse.

Moving off

With the parking brake set, move the selector lever to Neutral and start the engine. Shift into the range you wish to use, usually Range 1. After shifting be sure to remove your hand from the lever to allow the clutch to engage. To move off, release the brake and accelerate.

Do not release the brake before you are prepared to move, because power is transmitted to the wheels as soon as a gear is engaged.

Shifting

is easy. Simply release the accelerator pedal and move the gearshift lever from the range you are in to the range you

want, remove your hand from the gearshift lever, and again step on the accelerator.

For easier selection of the driving ranges 1 and 2, which are used most, the gearshift lever always stays on the right side when in Neutral, as shown in the illustration.

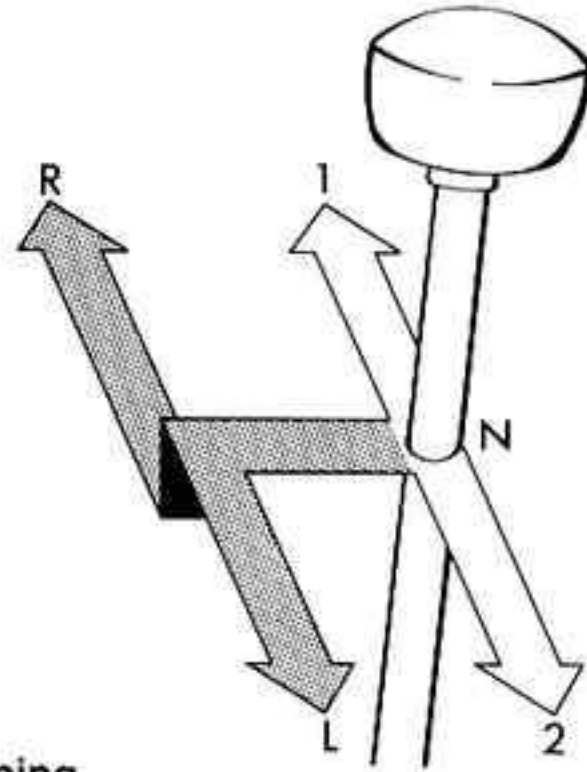

Stopping

Release the accelerator and apply the foot brake. If you are going to start off again in another range, you may shift into the new range while the vehicle is standing still, but if you remain in a driving range apply the foot or parking brake to prevent the vehicle from creeping.

Do not remove the key from the ignition/steering lock until you have parked your car, because removal of the key locks the steering.

If you like quiet, smooth driving,

which saves fuel, we recommend that you shift to Range 2 at about 20 to 25 mph.

If you want maximum acceleration

you can stay in Range 1 right up to 53 mph and then shift into Range 2. Naturally, this will use more fuel.

Keep in mind . . .

- 1 – When starting off, shift into a driving range before releasing the parking brake.
- 2 – After shifting, remove your hand from the selector lever.
- 3 – When idling for an extended period of time, shift into Neutral and apply the parking brake. When stopped in traffic, apply either the parking or foot brake to prevent creeping.
- 4 – When parking, apply the parking brake. On hills also turn wheels toward the curb.

Starting hints

Fasten your seat belts!

Never start or let the engine run in an enclosed unventilated area. Exhaust fumes from the engine contain carbon monoxide which is colorless and odorless. Carbon monoxide, however, is a very harmful gas, and can be fatal when inhaled.

Before turning the ignition key, make sure the gearshift lever is in Neutral. The Automatic Stick Shift can be started in Neutral only.

As soon as the engine starts, release the ignition key.

If the engine does not start the first time or stalls, turn the ignition key all the way to the left and restart.

Operate the starter for a few seconds only.

Summer starting

Operate the starter while slowly depressing the accelerator pedal.



Winter starting

First depress the accelerator pedal fully and release slowly to activate the automatic choke. Then start the engine.

On the Manual Transmission, also depress the clutch pedal when starting so that the starter only has to crank the engine.

Do not try to warm up the engine by letting it idle with the car stationary ... drive off immediately and maintain moderate speed until the engine is warm.

Starting the engine at operating temperature

Before operating the starter, depress the accelerator pedal fully ... **do not release it.** Now start.

Sun visors

To protect the driver from side glare, the sun visor on the driver's side can be moved toward the door window after lifting it out of its center mounting. The sun visor on the passenger's side cannot be moved toward the side.

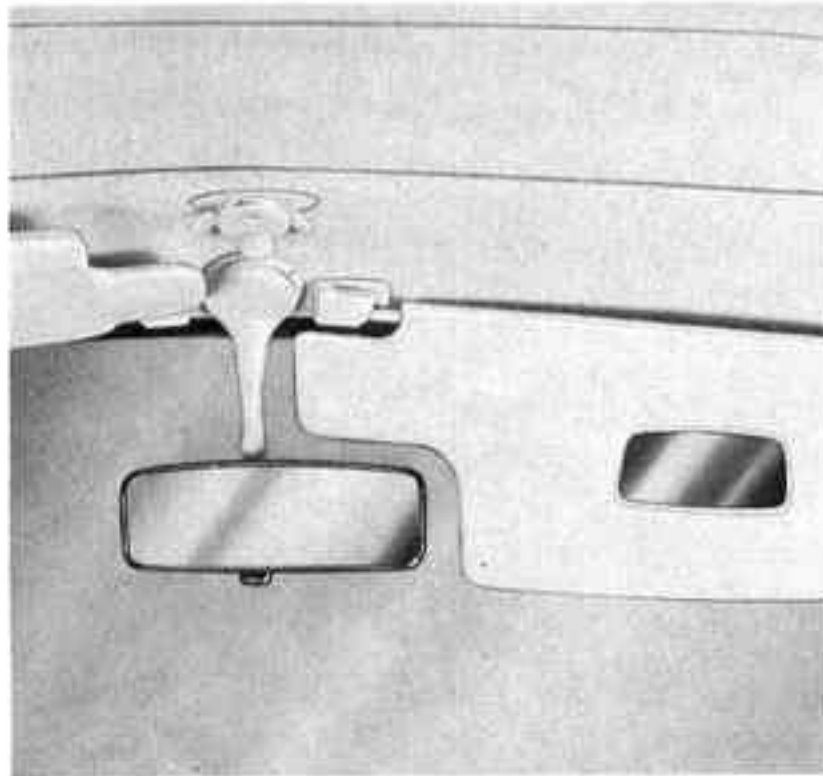

A vanity mirror (except VW 111) is on the back of the sun visor on the passenger's side.

Interior light

The switch positions are

- Up – ON (with doors open)
- Center – OFF
- Down – ON (with doors closed)

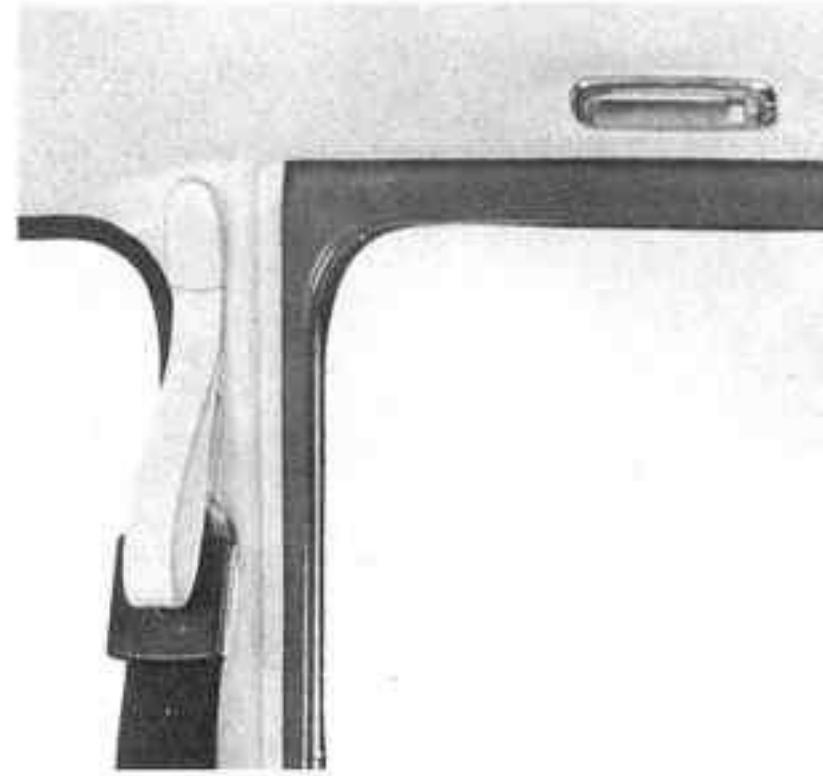

On the VW Convertible, the interior light switch are on the mirror bracket.

The switch positions are

- Left – ON (with doors open)
- Center – OFF
- Right – ON (with doors closed)

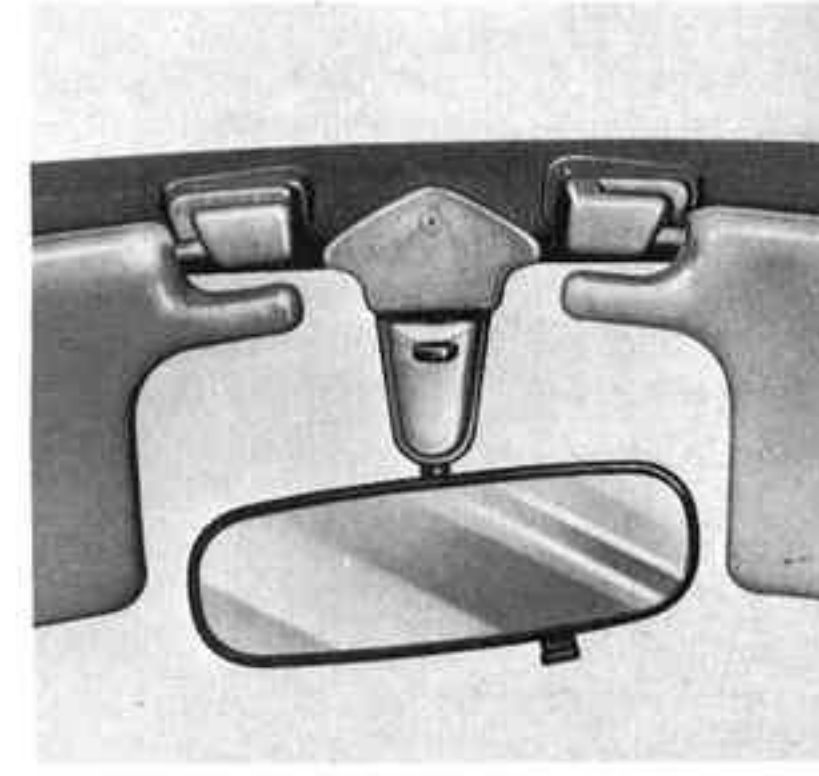

Assist straps and coat hooks

There is one assist strap and one coat hook on each side on the door post.

Hang clothes in such a way that they do not impair the driver's vision.

Ashtrays

You will find one ashtray under the instrument panel and two in the rear passenger compartment. The VW 111 only has one ashtray in the rear on the right.

Front ashtray

Pull to open it. To remove the tray depress the leaf spring which you see on the left just beneath the top cover. Now pull out the tray.

To put it back in, fold the top cover down, insert the tray in the guide rails and push in with the heel of your hand.

Rear ashtray

To remove it, press down on the tray and pull out. Insert the bottom of the tray first, then push in.

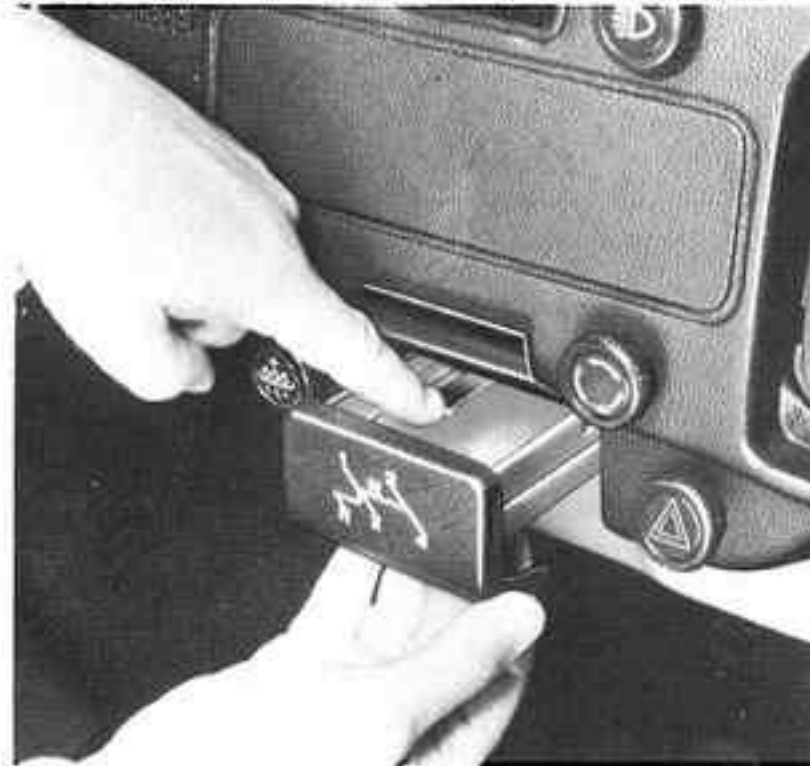

Lockable glove compartment

(except VW 111)

- To open – Turn knob to the left
- To close – Press door; lock engages
- To lock or unlock – Turn key to right or left

Inside the glove compartment is the **release lever for the front hood**. A locked



glove compartment prevents access to the luggage compartment and the spare wheel.

You will appreciate this feature when you carry personal items in your car and have to leave it open, for instance, at a garage or in a parking lot.

Luggage compartments

Your VW has two luggage compartments, one under the front hood, and the other behind the rear seat.

Since improper weight distribution can affect the car handling, take advantage of the two luggage compartments. Load the front luggage compartment first, using the heaviest pieces of luggage, if possible.



Front luggage compartment

To **unlock** the front hood, pull the release lever inside the glove compartment. See previous page.

Now open the front hood by depressing the release button in the hood handle.



To **lock** the front hood, lower the hood and press the handle down firmly. Do not press on one side of the hood. Make sure the hood is securely locked.

Rear luggage compartment

Additional luggage can be stored in the space behind the rear seat. You can expand this luggage area by folding the backrest down and fastening it in this position.

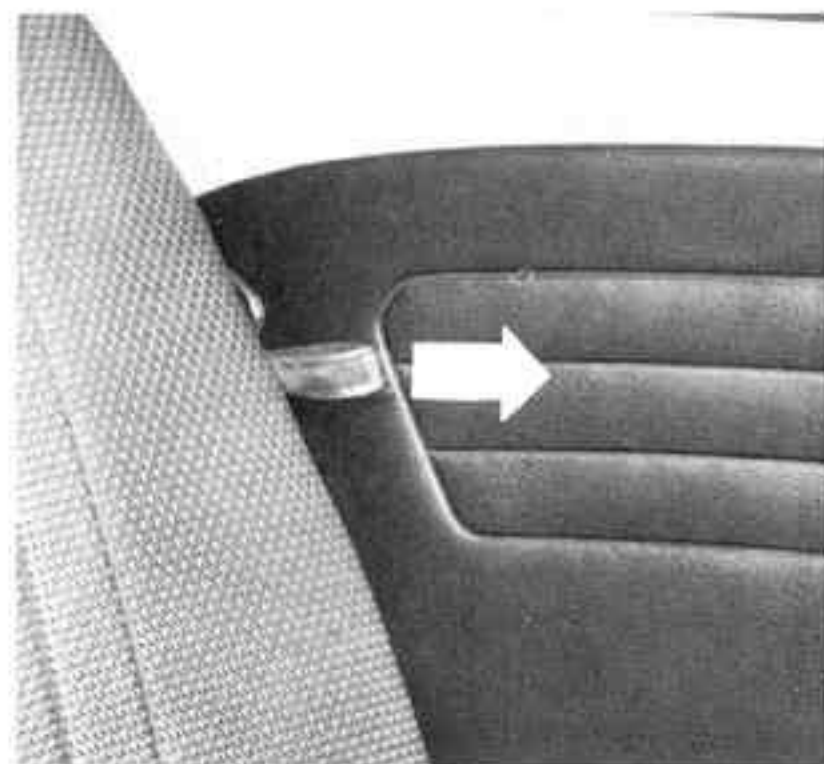

To **release** the backrest, pull the strap on the left, as seen in driving direction. When you fold the backrest back, it locks automatically in its place.



To **hold** the backrest in the folded-down position, hook the retaining strap (on the back of the backrest) under the seat rail.



To **tighten** the strap, move the slide and thread the loop/slide section through the buckle.



Articles stored in the luggage area behind the rear seat can be concealed from the outside view by a **cover**. This cover is attached with hinges to the backrest.

To make use of the cover, release the backrest and fold it forward. Lift the cover up. Then move backrest and cover back. The cover will rest on the edge below the rear window.

We recommend you do not place articles on the cover. Such items may become dangerous projectiles when dislodged during a sudden stop. They may also reduce the driver's vision to the rear.

Heater/Defroster

The fresh air heater/defroster is standard equipment on your Volkswagen. The control levers are located on the tunnel between the front seats.

1 a – Heater temperature lever

The lever toward the passenger's seat controls the temperature level.

Lever up – heat on fully
Lever down – heat off

By setting it at any intermediate position, you can select the degree of heat that is most comfortable for you. After a reasonable warm-up time, which also depends on the speed of your car, the warm air will enter the car through the three defroster vents (1) and the two defroster/fresh air vents (2a) at the lower edge of the windshield.

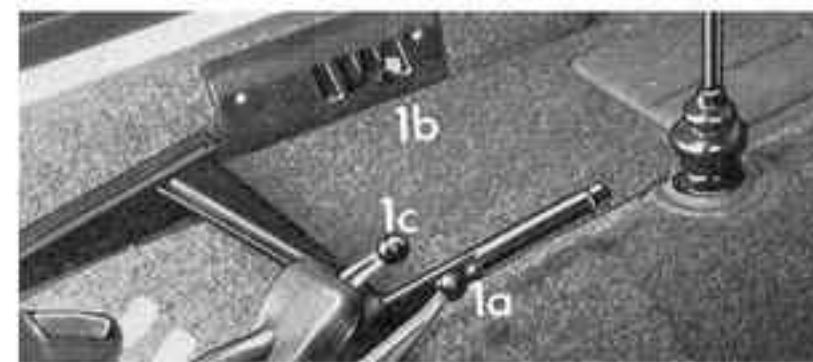

1 b – Heat outlet with control lever for front footwell

For each side, there is a footwell heat outlet. It is located just beneath the doors. You can control the flow of warm air from these outlets to the front footwells on each side with a lever.

Pull lever backward – open
Push lever forward – closed

1 c – Heat control lever for rear footwells

With the lever on the tunnel next to the driver's seat you can control the heat in the rear footwells.

Lever down – heat off in the rear
Lever up – heat fully on in the rear

You can select any intermediate position to regulate the heat for the rear footwells.

Hints for defogging and defrosting

Defogging and defrosting your windshield will be more effective if you direct the total air flow toward the windshield.

Here is what to do:

Heater temperature lever (1 a) all the way up – heat is on

Front footwell outlet levers (1 b) pushed forward – no heat to the front footwells

Rear footwell control lever (1 c) all the way down – no heat to the rear footwells

Levers in the vents (2 a) below the windshield straight up – air toward windshield

Now all air is directed toward the windshield.

Ventilation

Flow-through ventilation provides a continuous draft-free exchange of air while driving. Air enters the car through the grille on the front hood and the inside vents below the windshield. A water separator prevents rain from entering.

A two-speed electric fan behind the instrument panel increases the flow of air when driving at low speeds and also supplies fresh air when the car is standing still (ignition on).

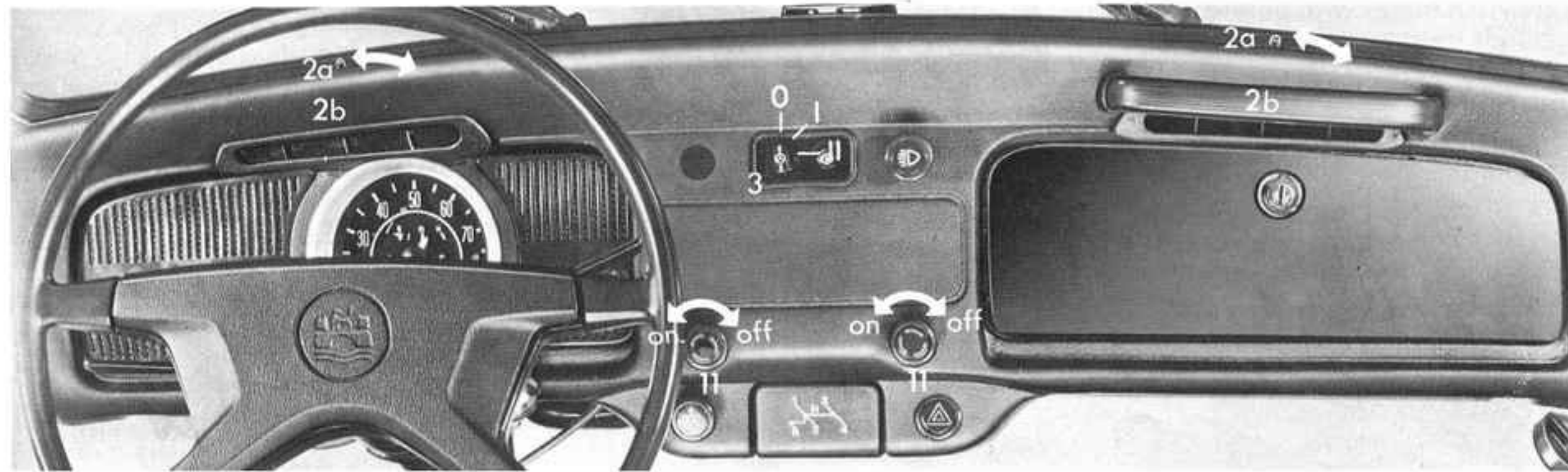

11 – Fresh air control knobs

You can regulate the volume of fresh air for each side separately by turning the knobs.

Turn left – air flow increases

Turn right – air flow decreases

To stop the air flow completely, turn the knobs to the right beyond the pressure point.

2a and 2b – Fresh air vents

Fresh air comes out through a pair of vents on each side.

Each upper vent has a lever. When the lever is in the straight-up position the air is directed toward the windshield. In the down position (move lever to the right), the air is directed into the passenger compartment. Air will flow in both directions when you select an intermediate position.

3 – Fresh air fan

(optional on VW Sedan 111)

You can increase the regular air flow by turning on the two-speed fan.

The switch positions are:

- 0 – off
- I – low speed
- II – high speed

The fan operation is most effective if you have opened the fresh air vents by turning the control knobs all the way to the left.

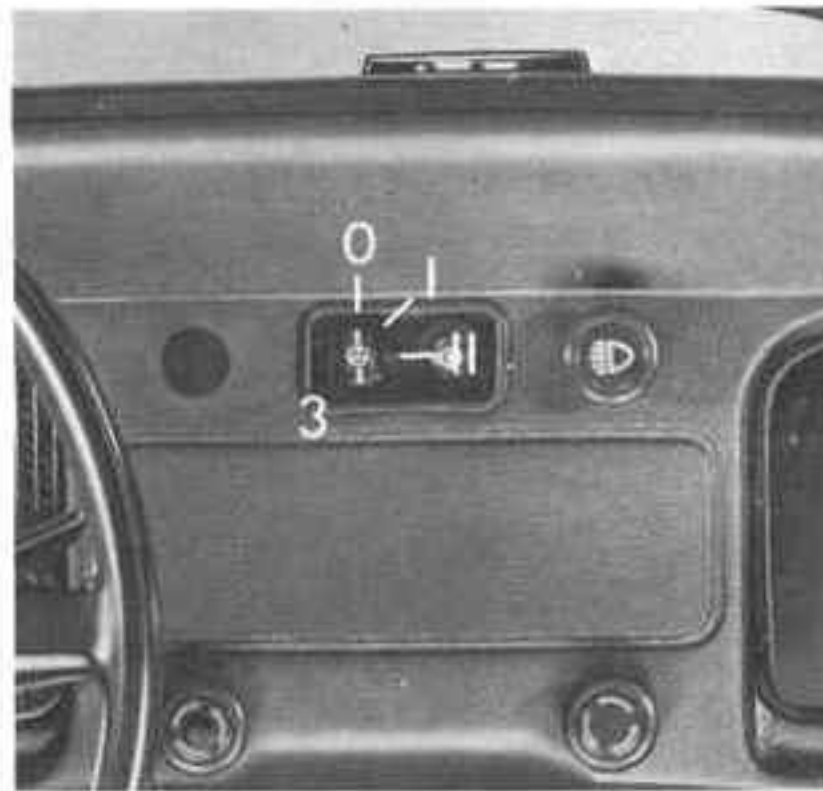

To give you full battery power while starting the engine, operating fresh air fan will stop automatically at this moment.

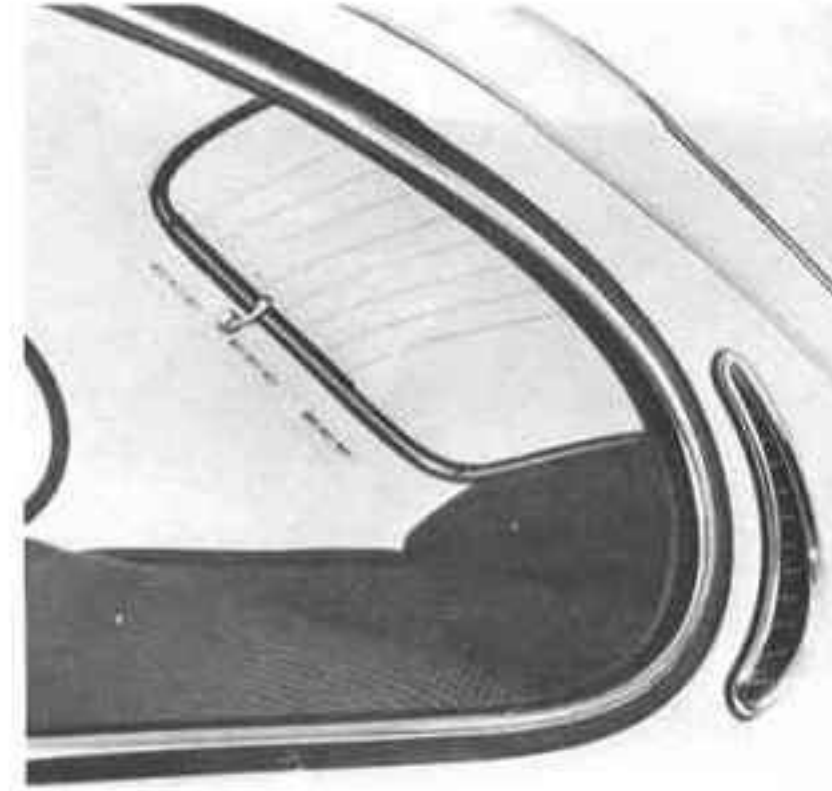

The air in the passenger compartment is drawn out through inside openings near the rear window and escapes to the outside through louvers.

Sliding roof

(optional on the VW 113)

We call the VW with a sliding roof the VW Sunroof.

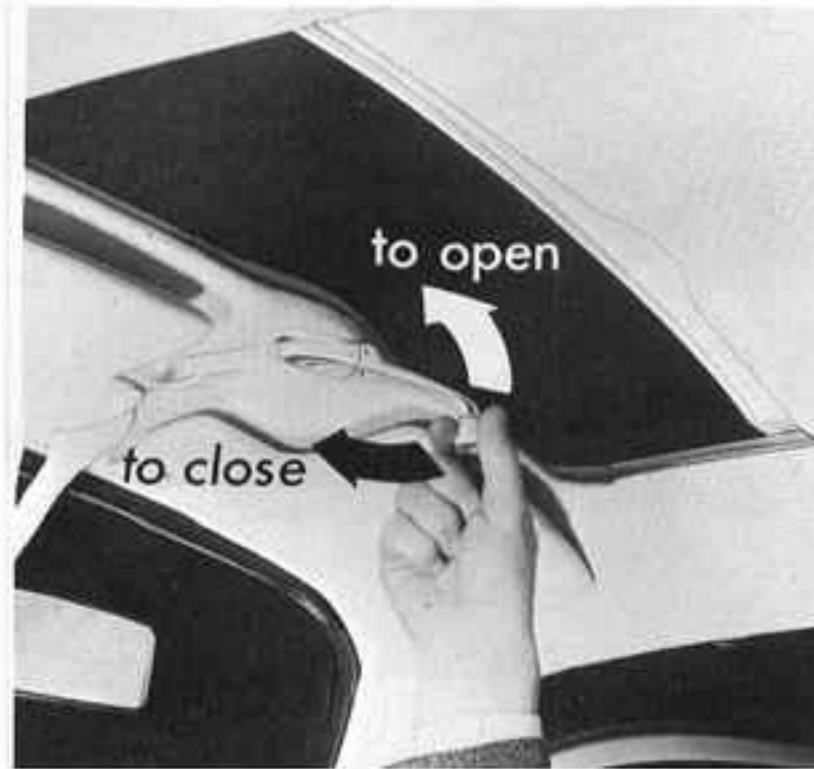

To open the sliding roof, pull the handle out and turn it counterclockwise; to close the sliding roof, turn the handle clockwise. You can lock the sliding roof in any open position by folding the handle into its recess.

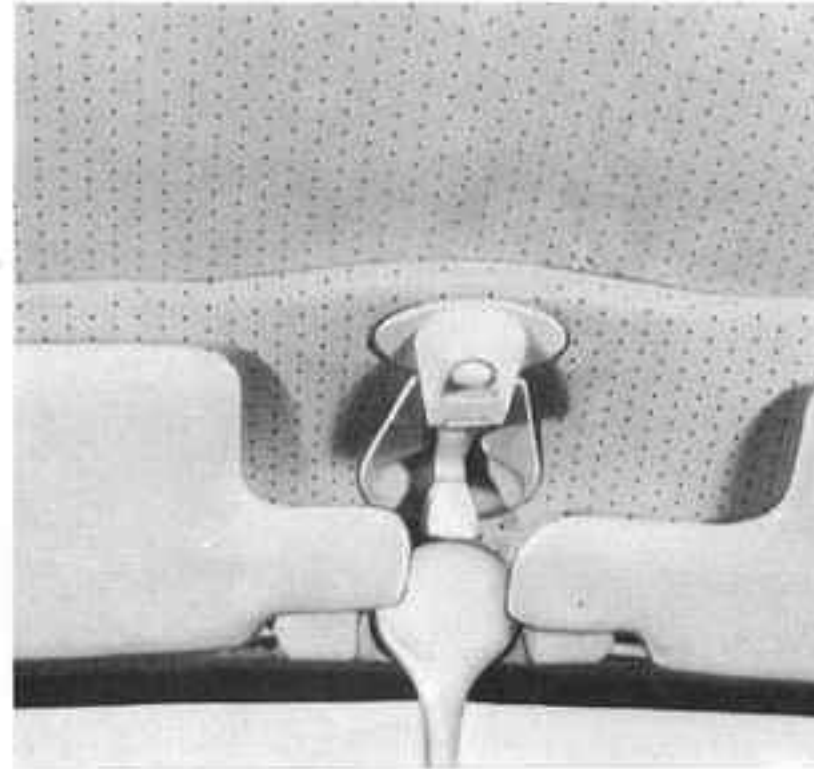

For safety reasons, make sure the handle is always recessed as shown in the illustration.

Convertible top

How to open the convertible top

The top should be dry before you open it. Keep the rear windows up; they serve as a guide for the convertible top to fold back.

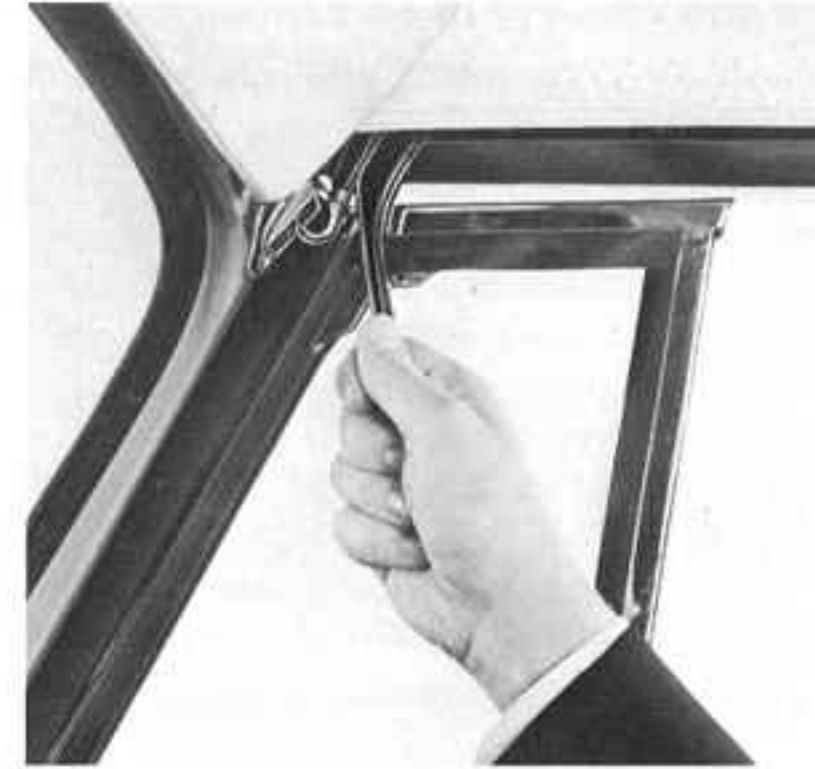

1 – First release the locking levers on the sides above the windshield. While folding the top back, pull the top



cover and padding toward the rear and the headliner toward the front so that the top material does not get caught in the linkage.

2 – Press down the top to engage the locking catches on both sides.



3 – Now take the covering boot (a separate cover that comes with every new VW Convertible) and slide it over the folded-down top. Tuck in the sides. Fasten all snaps and rubber straps of the boot securely to the body.

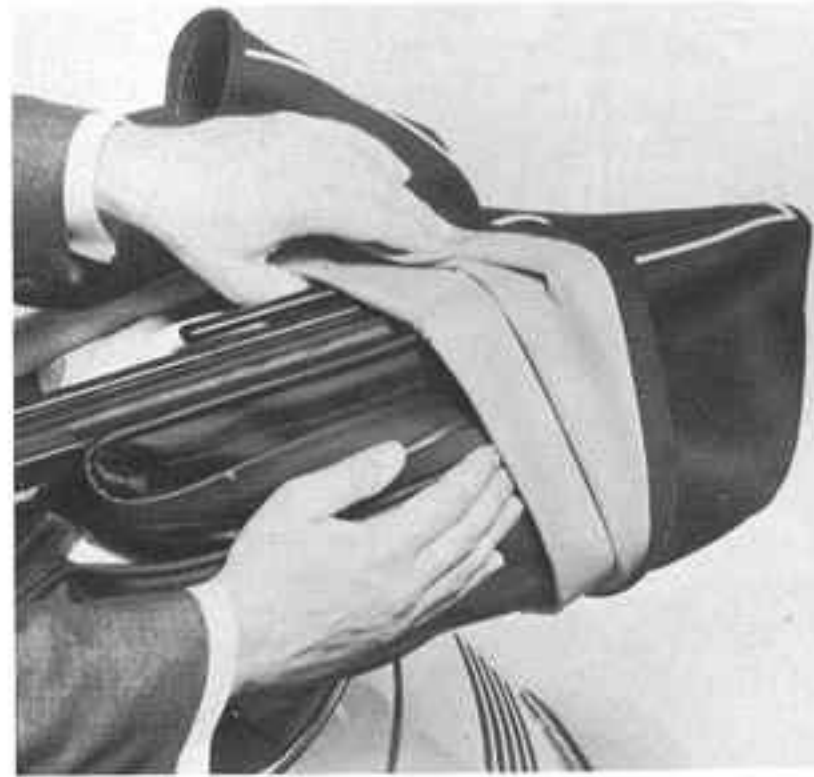

The top should never be opened or closed while the car is in motion.

How to close the convertible top

- 1 – The top should be dry before closing it. First take off the boot and turn down the rear windows. Press the top down lightly to disengage the locking catches on both sides. Fold the top up and toward the front.
- 2 – From inside the car, grasp both levers and pull the top forward until the pins enter the guide holes on the windshield frame.
- 3 – Engage the hooks at the end of the lever into the grasping brackets above the windshield frame. Now lock the top tightly by pushing the levers upward.
- 4 – As a last step, open and close the rear windows to properly position the weatherstrips.

VW Air Conditioner

(optional equipment)

Operating controls

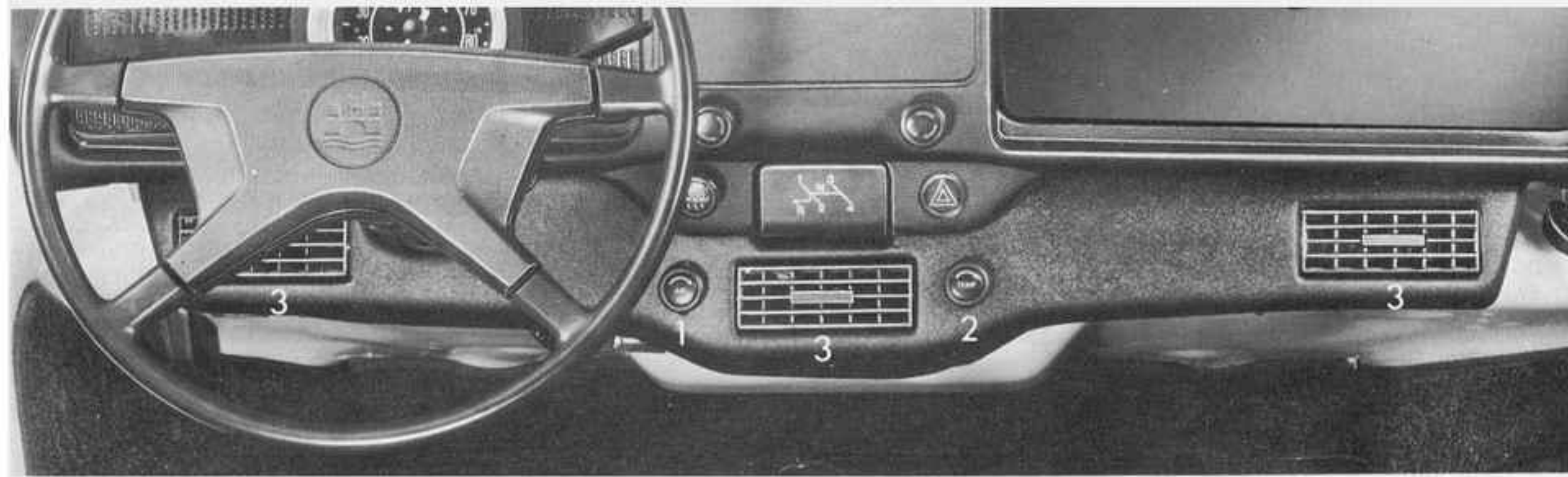

1 – Air volume switch (“AIR”)

This switch serves two functions. It turns the air conditioning system on and off and controls the fan speed. The fan positions are:

- 1st position – **HIGH**
- 2nd position – **MEDIUM**
- 3rd position – **LOW**

2 – Air temperature switch (“COLDER”)

By progressively turning this switch to the right, the desired cooling range can be selected. It is in the coldest position when turned as far as possible to the right.

3 – Air discharge louvers

These movable louvers can be adjusted by moving the center vane to direct the conditioned air flow upward, downward or sideways.

Starting the Air Conditioner

With the engine running, windows and fresh air regulator closed, turn the air temperature switch to the desired position and select the air volume speed desired. On extremely hot days turn the air volume to full capacity and open a window. Within a few minutes, the hot air will be forced out of the car and the window can be rolled up as cooling starts.

Adjust the air discharge louvers to the desired position.

Stopping the Air Conditioner

Turning the air volume switch to the "OFF" position stops the entire air conditioning system.

When shutting off the engine, the air conditioner should also be turned off and not turned on again until the engine is running. This is to reduce the load on the electrical system and conserve the battery.

Operational hints

If the volume of cold air suddenly decreases it is likely that the evaporator coil is "icing up". To remedy this, turn the air temperature switch to the left and leave in this position until the air volume is back to its original rate.

If the car interior becomes too cold after adjusting the air volume, turn the air temperature switch to the left until the desired comfort level is reached.

If the windows fog over on the **exterior** on warm, humid days, turn the air temperature switch to the left until the windows clear up, or turn the windshield wipers on.

If the windows fog over on the **interior**, they can be quickly cleared by turning on the air conditioner.

During highway driving, set the air temperature switch in approximately the middle position.

Maintenance hints

During the winter season, it is advisable to operate your Air Conditioner for a brief moment every week. This will help to keep the seals and fittings properly lubricated.

After the winter months and before extended summer usage, the air conditioner should be checked and, if necessary, serviced by an Authorized VW Dealer.

The condensers should be checked periodically for cleanliness. If the louvers are clogged, the condensers should be washed down with water.

If, upon inspection, the condenser fins are bent, the car should be taken to an Authorized VW Dealer for straightening of the condenser fins.

Circuit breaker

An automatic resetting circuit breaker for the current supply of the air conditioning system is located under the rear seat. It is connected directly to the battery.

VW Auxiliary Heater (Optional equipment)

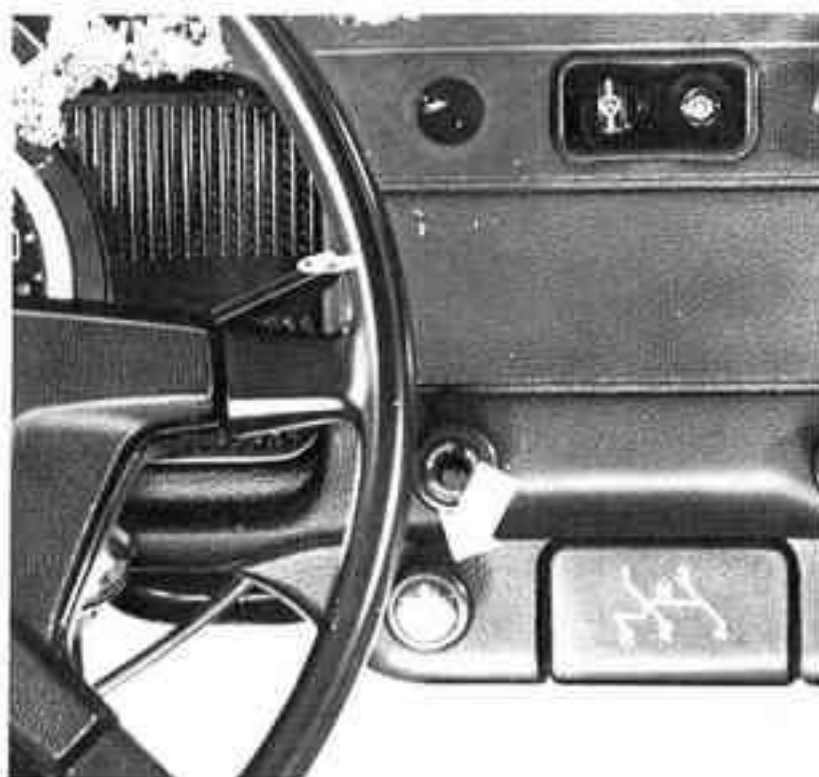

To switch the heater on, pull the knob (arrow) out. This lights up a green warning lamp in the knob.

To avoid an unnecessary drain on the battery switch the heater off after about 25–30 minutes if the engine has not been started in the meantime.

Do not start or let the engine or heater run in an enclosed, unventilated area to warm up the car. Exhaust fumes from the engine or gasoline heater contain carbon monoxide, which is colorless and odorless. Carbon monoxide, however, is a very harmful gas, and may be fatal when inhaled.

To switch the heater off, push the knob in. The warning lamp then goes out but the blower motor continues to run until the heater has cooled down.

The heater must be switched off when filling the tank.

When it is very cold, the full battery capacity is required to start the engine. To avoid starting difficulties, it is advisable not to preheat the vehicle interior under these conditions, that is to say, do not switch the heater on until the engine is running.

The heater normally requires no special maintenance. It is advisable, however, to have the heater plug checked once a year before the cold weather sets in and a new plug installed if necessary. The fuel system should also be checked for cleanliness and the electrical connections for tightness.

During the winter and when driving over very poor roads, mud or snow may tend to accumulate in the exhaust and combustion air intake pipes. Have these pipes checked for blockage from time to time so that the heater continues to work properly.

When the heater is not used for long periods, for instance during the summer, gum-like deposits from the fuel can settle in the fuel lines. To avoid trouble due to these deposits, it is advisable to operate the heater briefly about once a month when it is not in regular use.

Heat output: 8,000 BTU/h
Fuel: Gasoline from fuel tank
Fuel consumption:
appr. 0.7 pint/h (0.6 Imp. pt/h)
Current consumption: 40 watts

Towing and trailer hauling

Your Volkswagen is equipped with two towing eyes, one at the front and one at the rear. They are for emergency towing over short distances only.

When towing your VW place the gearshift lever in Neutral. Turn the ignition on to be able to operate headlights, indicator lights and stop lights. Be sure to release the parking brake.

Rear

A towing eye is attached to the left rear bumper bracket.

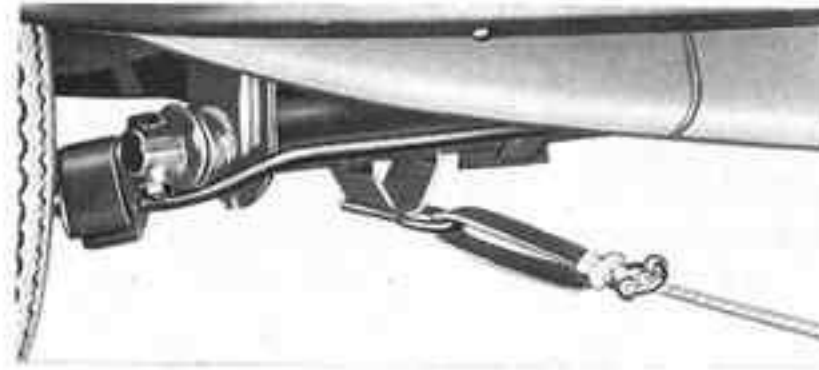
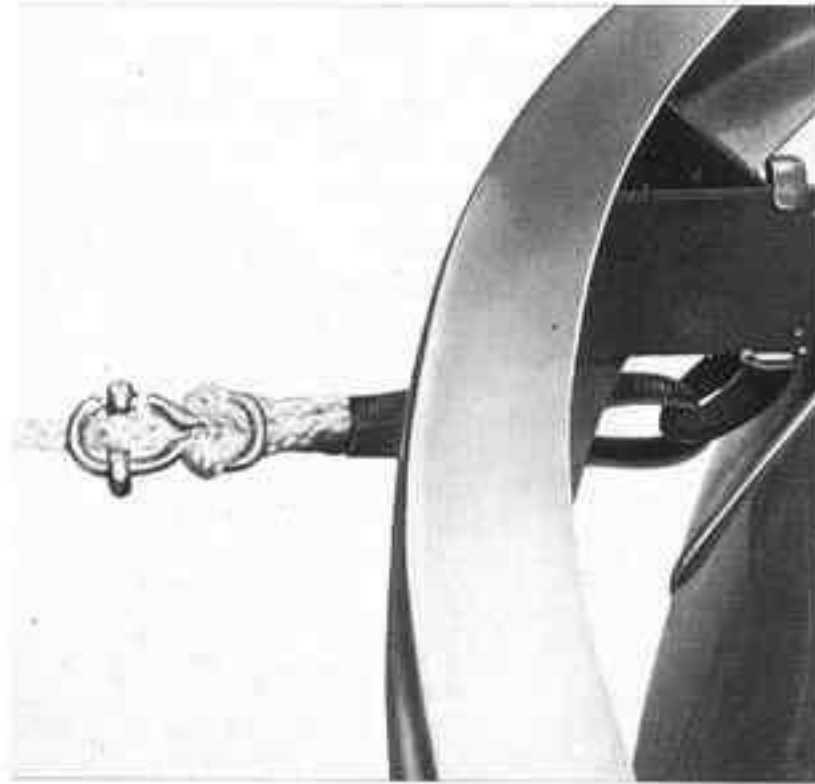

Front

On the **VW 111**, a towing eye is welded to the right-hand side of the lower axle tube.

The **VW 113** and **VW Convertible** have a towing eye welded to the right-hand side of the frame head.

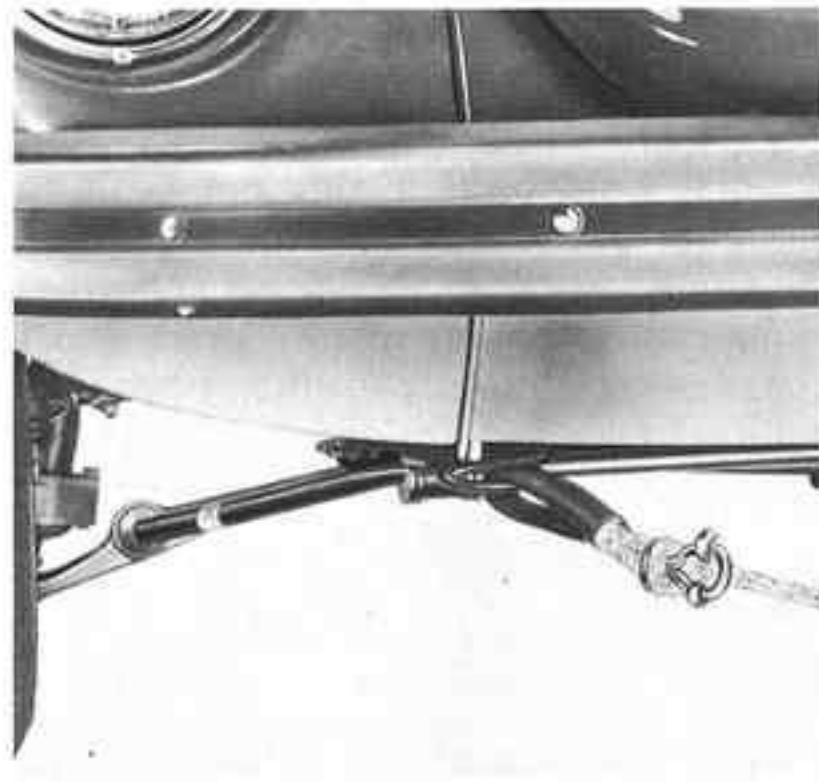

Always observe state laws and municipal ordinances governing towing.

Please keep in mind . . .

The towing eyes on your Volkswagen are not designed for towing by commercial tow trucks. Also, never have your VW towed by the bumper.

The driver of the towing car must be very careful when driving off and shifting to avoid sudden and abrupt pulls.

The driver of the towed car must always keep the tow rope taut.

Trailer hauling

It is possible to tow a trailer with your Volkswagen. When towing a trailer, start out in the Low driving range (Automatic Stick Shift) with this extra load. Also, shift to a lower gear or range when driving up or down steep hills.

The total weight of a trailer (without brakes) should not exceed 882 lbs. The trailer tongue load should be 55 to 90 lbs. Distribute load in the trailer evenly. And remember: the additional trailer weight affects the braking of your car so that a longer distance is needed to bring the car and trailer to a stop. Test the brakes before starting out on a trip with a trailer.

Winter operation

Your W has an air-cooled engine. Do not, under any circumstances, try to increase the engine temperature by covering the louvers below the rear window or those in the rear hood. These louvers must always be kept open so that air can flow to the carburetor and the engine cooling fan.

Battery

During the winter months, the battery is subjected to greater use than in the summer months. More current is consumed when starting at very low temperatures. Lights and the rear window defogger are used more often. Besides, the battery tends to decrease in capacity as the temperature drops.

Therefore, it is very important to keep your battery in best possible condition. See also "Battery" on page 66.

Do not expose battery to open flame or electric spark as hydrogen gas generated by the battery is explosive. Do not let battery acid come in contact with skin, eyes, fabric or painted surfaces.

A really cold battery may not be fully charged, and therefore does not have the same capacity as a battery at normal temperature. If you mainly drive short distances or in city traffic, have the battery checked and, if necessary, charged between regular inspections.

Door locks

can freeze in the winter if water gets into them. When washing your car in the winter, do not aim the water jet directly at the locks. It is a good idea to put tape over the keyholes to prevent the water from seeping in. Water in the locks must be removed with compressed air afterwards. Squirt lock de-icer, anti-freeze, or glycerine into the lock cylinders to prevent the locks from freezing.

To open a frozen lock, warm up the key before inserting it. It might also help to warm the lock. Do not use hot water as it will later freeze in the lock.

Emergency equipment

It is good planning to carry emergency equipment in your car. Some of the things you should have are: window scraper, snow brush, container or bag of sand or salt, flares, small shovel, first-aid kit, etc.

Engine oil

To make starting easier during the cold winter months, we suggest you choose a thinner grade motor oil. Turn to page 73 for the recommended oil grades.

If you drive mostly short distances and in city traffic, we recommend you have your engine oil changed at 1500-mile intervals in the winter.

Transmission oil

SAE 90 grade transmission oil can generally be used all year round. Only in areas with a cold climate is it necessary to use the thinner SAE 80 transmission oil during the winter months.

In arctic climate and areas with temperatures consistently below -13° F, use Automatic Transmission Fluid (ATF) for the manual transmission and final drive. When the temperature rises, replace the ATF with SAE 80 or SAE 90 grade transmission oil. See also page 74.

Windshield washer

Add anti-freeze to the washer fluid, such as Volkswagen's Windshield Washer Anti-Freeze & Solvent, to prevent it from freezing. Follow the instructions on the can for the right amount to be used.

Spark plugs

Make sure the spark plugs are not worn or have a gap larger than .028 in.



Tires



Your Volkswagen is equipped with tubeless bias ply tires. Size 5.60-15. Volkswagen tires comply with all applicable U.S. Federal Motor Vehicle Safety Standards.

For maximum safety, always buy replacement tires that show the same specifications with regard to tire size, load carrying capacity, tread pattern, etc. This also applies to VW-recommended alternate replacement tires.

Tire pressures

For good car handling and long tire service life, it is important to maintain recommended tire pressures. Tires which are inflated above or below specifications can cause increased tire wear, increased gas consumption and affect the road holding of the car.

VW-recommended **cold tire inflation pressures** are listed on a sticker on the inside of the glove compartment door.

They are:

	front	rear
with 1–2 occupants	16 psi (1.1 kg/cm ²)	27 psi (1.9 kg/cm ²)
fully loaded	19 psi (1.3 kg/cm ²)	27 psi (1.9 kg/cm ²)

VW 111

with 1–2 occupants	16 psi (1.1 kg/cm ²)	24 psi (1.7 kg/cm ²)
fully loaded	17 psi (1.2 kg/cm ²)	26 psi (1.8 kg/cm ²)

For long, high-speed driving, the tire pressure should be increased by 3 psi (0.2 kg/cm²) at front and rear. **Do not exceed the maximum tire inflation pressure listed on the sticker.**

In the interest of safety, check the tire pressure of all tires, including the spare tire, at least once a week, and always before going on a long trip.

Spare tire pressure

Since the spare tire supplies the pressure to operate the windshield washer, the pressure of the spare tire should be between 28–42 psi (2.0–3.0 kg/cm²). This pressure level is only to be maintained for the operation of the windshield washer system. For road use, the pressure in the spare tire should be adjusted as specified on the left side of this page. See also page 58.

Tire rotation

If uneven tire wear should occur, we recommend that the tires be rotated as shown in the sketch below. Afterwards, the tire pressures must be corrected, and the wheel bolts torqued diagonally to 110 ft. lbs.

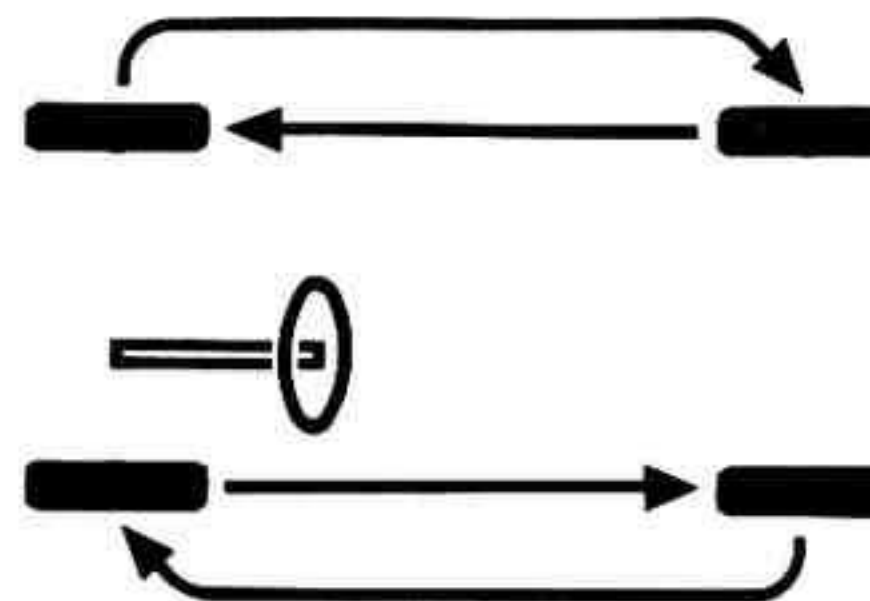

Wheel balancing

A wheel should always be balanced after a tire repair. Also, since regular use can cause tire imbalance, the wheels should be balanced from time to time. Unbalanced wheels may affect car handling and tire life.

Tire wear

The original equipment tires on your VW have built-in tread wear indicators. They are molded into the bottom of the tread grooves and will appear as approximately 1/2 inch bands when the tire tread depth becomes 1/16 of an inch. When the indicators appear in two or more adjacent grooves, it is time to replace the tires. We recommend, however, that you do not let the tires wear down to this extent. Worn tires cannot grip the road surface properly, and are even less effective on wet roads.

Do not drive with worn tires or tires showing cuts or bruises as they may lead to sudden deflation.

If you notice that tires are wearing unevenly, consult your Authorized VW Dealer. Uneven wear may not always be due to improper wheel alignment. It can be the result of individual driving habits such as cornering at high speeds. If the tire pressure is not checked and adjusted regularly, abnormal tire wear can also occur.



Tire in good condition

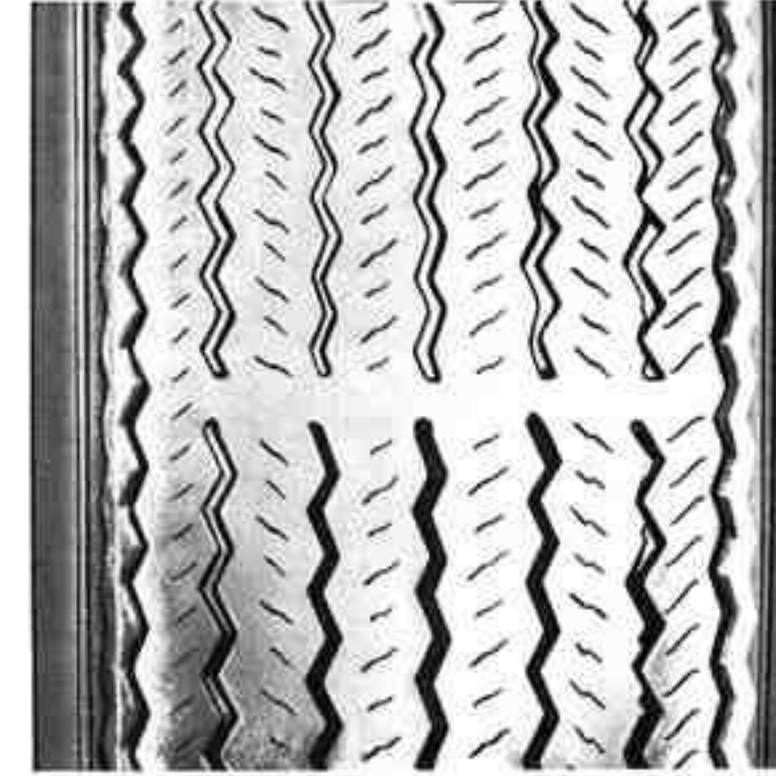

Indicator visible – tread worn

Tire replacement

To achieve best all-around car handling, replace all 4 tires at the same time. If this is not possible, replace tires in pairs, either front or rear. Do not combine tires of different design, size or tread pattern.

New tires do not possess maximum traction. They tend to be slippery. Break new tires in by driving at moderate speed for the first 60–100 miles.

Tire care

- 1 – Frequently check tires for damage. Remove imbedded material.
- 2 – Keep oil and gasoline away from tires.
- 3 – Replace worn tires or studs in time.
- 4 – Replace missing valve dust caps as soon as possible.

Winter tires

Winter tires give good traction in snow or slush.

For a better grip on hard snow or ice, you can use snow tires with studs, but **check with your State Motor Vehicle Bureau** for possible restrictions. Winter tires with studs should be run at moderate speed when new to give the studs time to settle.

Winter tires should preferably be mounted on all four wheels. They should also conform to the same load requirements as original equipment tires.

For winter driving, the tire inflation pressure can be increased by 3 psi (0.2 kg/cm²) above the normal operating pressures, as is also recommended for fast highway driving, **but do not exceed the maximum tire inflation pressure listed on the tire label.**

Snow tires do not fulfill their purpose if the tread depth is less than $\frac{5}{32}$ " (4 mm).

For safety reasons, it is not advisable to drive with snow tires at top speeds. Snow tires do not have the same degree of traction on dry, wet or snow-free roads as regular tires.

Spare wheel

The spare wheel is under the front hood. To unlock the hood, pull the lever inside the glove compartment.



In the **VW 113**, the spare wheel is stored horizontally under the luggage compartment cover.



In the **VW 111**, the spare wheel is stored in an upright position in the spare wheel well.

The spare wheel is connected to the windshield washer container and supplies the pressure to operate the washer. The air supply to the windshield washer will be interrupted automatically by a cut-off valve if the tire pressure drops to 26 psi (1.8 kg/cm²). This prevents the spare tire from being deflated below the required pressure.

Check the tire pressure from time to time and maintain it up to a maximum of 42 psi (3.0 kg/cm²). This pressure level is only required for the operation of the windshield washer system. For road use, adjust the spare tire pressure as specified on page 55.

To check or correct the pressure, first unscrew the hose from the valve near the filler cap of the windshield washer container. The spare wheel is connected to this valve and can therefore be pressurized via this valve. Reconnect the hose to the valve after checking or inflating the spare tire.

On the **VW 111**, disconnect the windshield washer hose from the valve of the spare tire. Reconnect the hose after inflating or checking.

Jack

The jack is only to be used for changing a wheel. Do not use it as a support to work underneath the car.

Note

There are two types of jacks, as shown below. Your Volkswagen is equipped with either one of these types.



The jack is located under the rear seat next to the battery. It is held in stowage position by a clamp. To take out the jack, lift the clamp. When putting the jack back in again, tighten the clamp.



Jack with lever

(The long breaker bar serves as the lever; it is in the tool kit.)



Jack with crank

(The base plate is stowed underneath the spare wheel. On the VW 111 it comes with the tool kit.)

Changing a wheel

If you have a flat tire, **move off the roadway. Turn on the emergency flasher. In addition, mark the position of your car with flares or other warning devices to alert other motorists.**

Before you change a wheel, be sure **the ground is level and firm, especially** near the rear wheels where the **jack ports** are.

Set the parking brake and block the wheels opposite the defective wheel on the other side of the car.

For a more efficient and safe changing of a flat tire, observe the following 10 steps.

Further down, we expand on these steps in greater detail.

- Step 1 – Take out tools, jack and spare wheel.
- Step 2 – Remove hub cap.
- Step 3 – Loosen wheel bolts. **Do not take them out.**
- Step 4 – Securely insert the jack in jack port. There is **one** for each side. It is under the running board toward the rear, and is used for front or rear wheel changing.

Never jack the car up by the bumper or the running board.

- Step 5 – Jack up car.
- Step 6 – Change wheel and handtighten wheel bolts.
- Step 7 – Lower car.
- Step 8 – Further tighten the wheel bolts.
- Step 9 – Replace hub cap.
- Step 10 – **Important:** Torque adjustment.

Step 1

Take out your tool kit.

Take out the **jack** from under the rear seat next to the battery. Just tilt the rear seat up and lift the clamp that is holding the jack in stowage position.

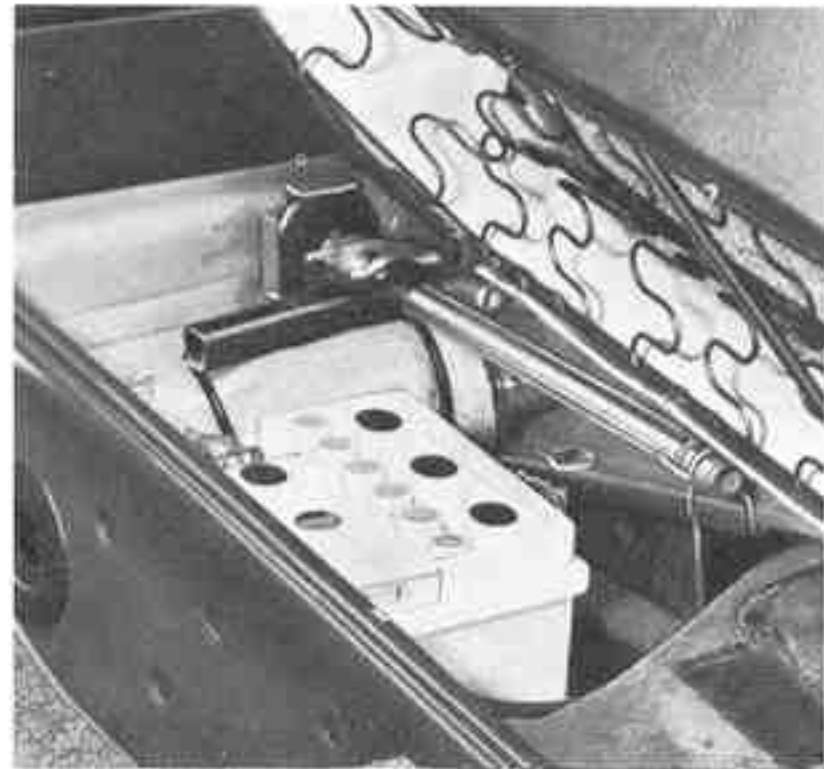

Before you take out the **spare wheel** from under the front hood, disconnect the hose leading to the windshield washer container (large arrows).

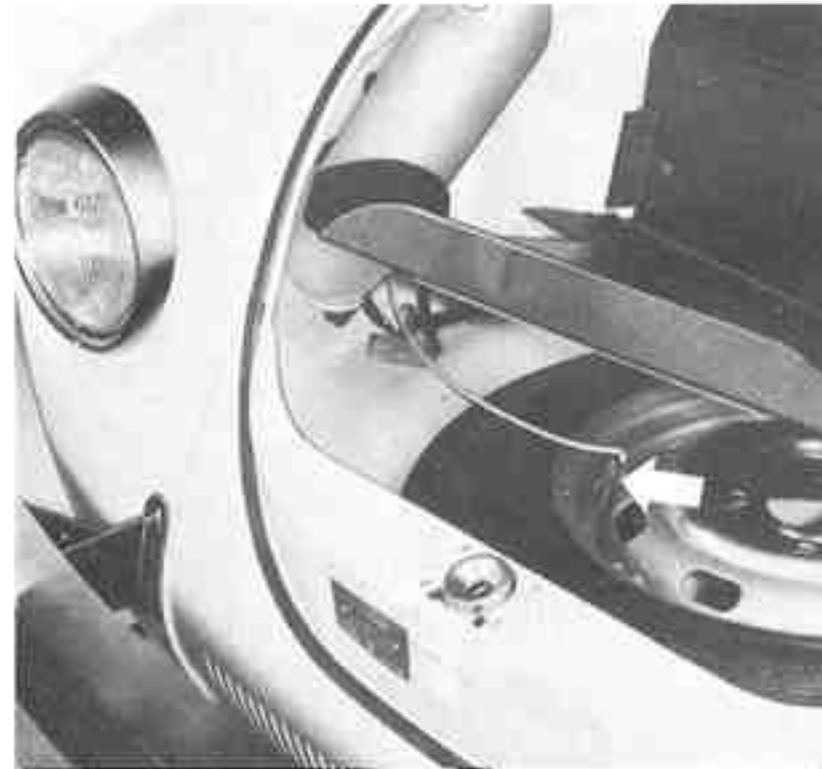

In the VW 111, lift the **spare wheel** up and place it on the edge or bumper. This way you have better access to the two wedges (small arrows), that hold the washer



container in the rim. Remove the wedges and separate the container from the wheel.

Step 2

With the wheels still firmly resting on the ground, remove the hub cap of the defective wheel.

Tools with special hub cap puller:



Insert the puller in the holes at the rim of the hub cap. Put the breaker bar through the puller, brace one end of the bar on the wheel rim and tug lightly on the other end.

Note: There are two types of tool kits. Your Volkswagen is equipped with either one of these kits.

Tools with breaker bar acting as hub cap remover:



Insert the flat end of the breaker bar between hub cap and rim and pry off.

When you place the hub cap inside out you can use it as a tray for your wheel bolts.

Step 3

Loosen all wheel bolts counterclockwise about one turn with the socket wrench. Insert the breaker bar to make full use of its leverage. **Do not yet remove the bolts.**



Step 4

Securely insert the jack into the jack port. There is one on each side under the running board toward the rear and is used for front and rear wheel changing. **Never jack the car up by the bumper or running board.**

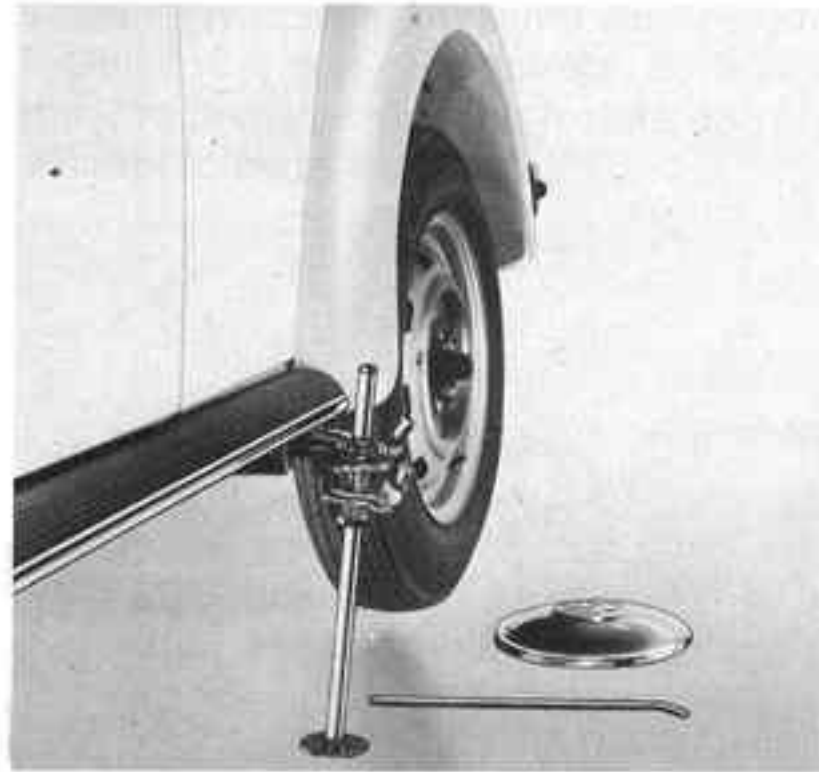

Provide for a **firm base for the jack on the ground**. If necessary, use a brick, a board, a flat rock, etc. Use the **base plate** that comes with the **jack with crank**. It is provided for this purpose.

Passengers should not remain in the car when the car is jacked up.

Step 5

When using jack with lever

To raise the car, insert the breaker bar in the upper slot –a– and pump the bar.

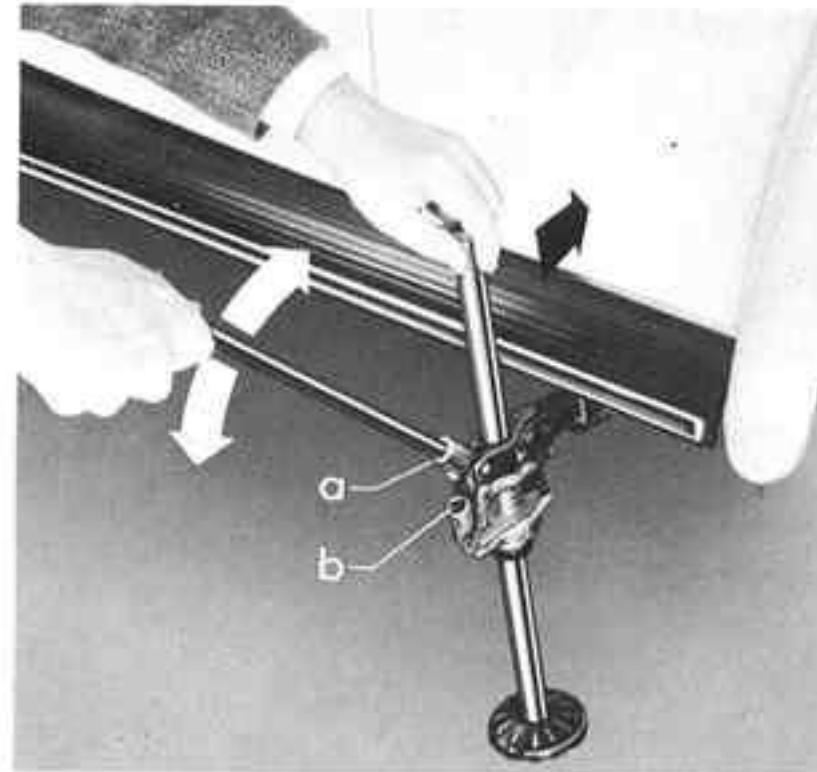

To get the jack as vertical as possible, push the upper part of the jack toward the body while you are jacking up the car.

When using jack with crank

To raise the car, turn the handle clockwise.

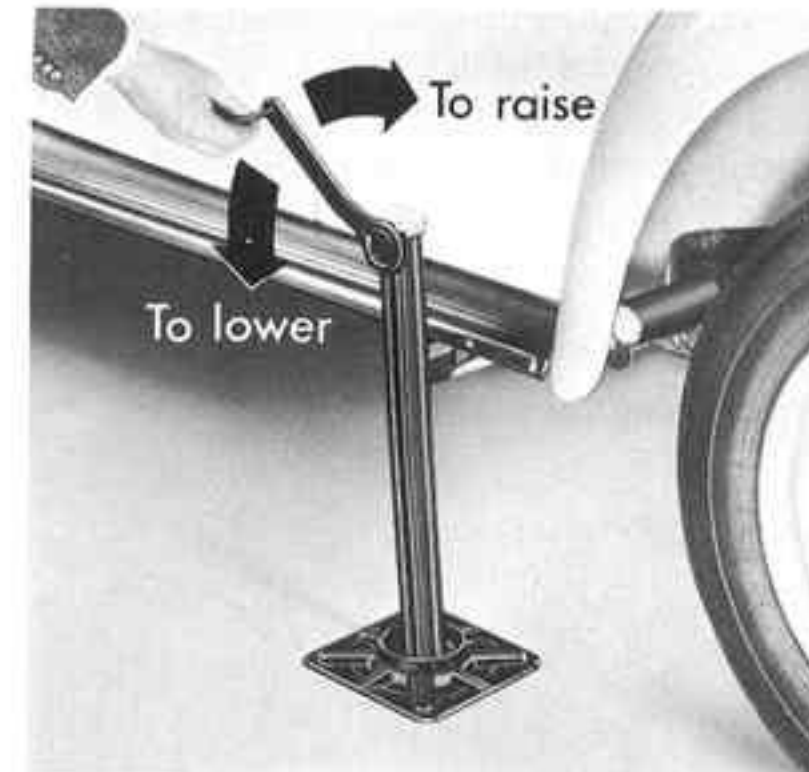

Only raise the car as much as is needed to change a wheel.

Do not raise the car until you are sure the jack is securely engaged.

Step 6

Fully tighten the wheel bolts and place them into the hub cap. Take the bolt at the top off last. Place the spare wheel against the brake drum and slightly rotate the wheel until a bolt hole in the wheel is in line with a threaded hole in the brake drum. Insert the wheel bolts and handtighten them crosswise before jacking the car down.

Step 7**When using jack with lever**

To lower the car, insert the breaker bar in the lower slot –b– and pump the bar.

When using jack with crank

To lower the car, turn the handle counterclockwise.

**Step 8**

Tighten crosswise from one bolt to another, tightening them firmly with the socket wrench and breaker bar.

**Step 9**

To install the hub cap, place it around the lower part of the wheel center, and with a firm push on the upper part, the hub cap will snap into place. Make sure it is properly seated.

Step 10

Correct tightness of the wheel bolts is important.

Tighten bolts diagonally to 110 ft. lbs. Have the bolts checked by your dealer or a service station with a torque wrench.

Also correct the pressure of the tire you have just put on.

Container for windshield washer fluid (1)

The windshield washer container has a capacity of 3.6 US pints (3.0 Imp. pints). To add washer fluid, just unscrew the filler cap. The container can be filled to the top.

As clear water is usually not adequate for cleaning the windshield, add a cleaning solution to the water such as Volkswagen's Windshield Washer Anti-Freeze & Solvent. It is a concentrate, so follow the directions on the can for the correct amount to be used.

You can use Volkswagen's Windshield Washer Anti-Freeze & Solvent all year round. It helps to keep your windshield clean, and prevents freezing of the washer fluid in the winter.

Since the spare tire supplies the pressure to operate the washer, it should always be kept up to a pressure of 42 psi (3.0 kg/cm²). How to pressurize the spare tire, see page 58.

Brake fluid reservoir (2)

The brake fluid should always be above the seam edge near the top of the reservoir. If it drops below this point, the cause should be corrected by your Authorized Volkswagen Dealer.

Every 2 years, the brake fluid has to be replaced.

See "Additional Services Record" on page 91 and "Scheduled Maintenance" on page 95.

Only **new, unused** brake fluid that meets the SAE recommendation J 1703 must be used.

Volkswagen Sedan 111

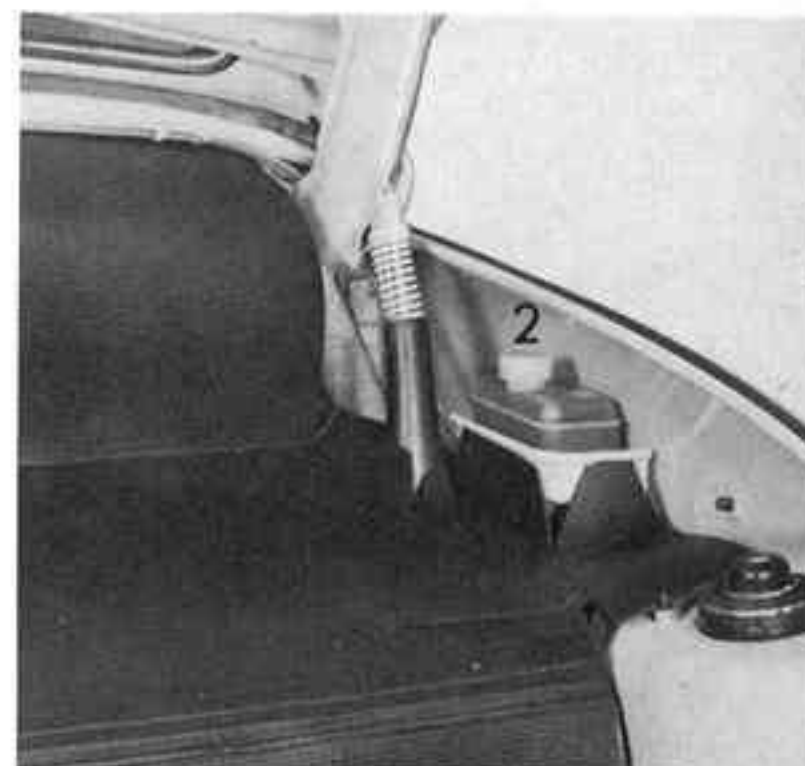
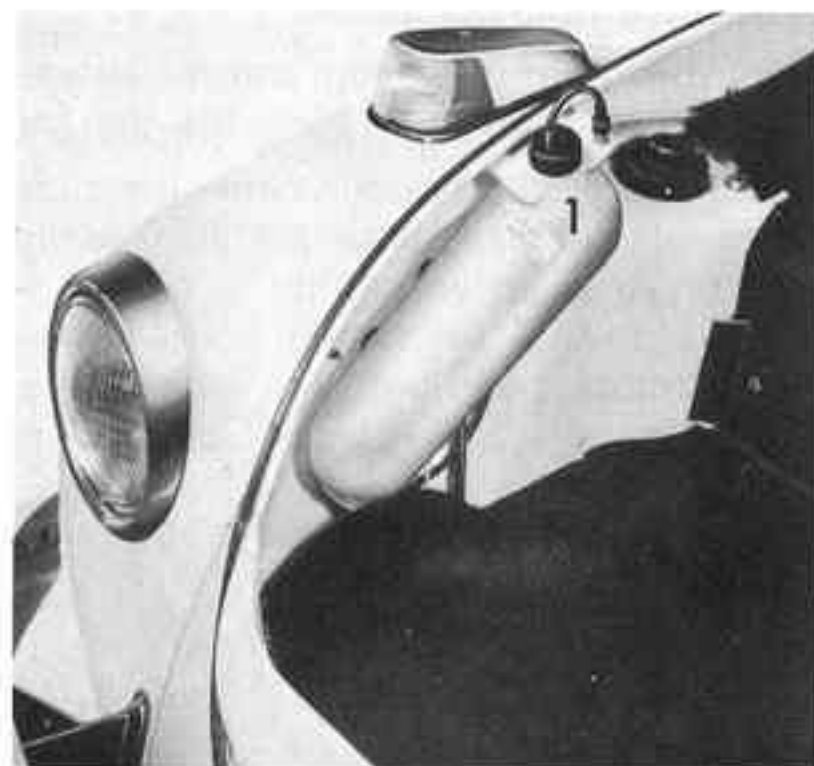

Battery

The battery is under the rear seat on the right-hand side in driving direction. Just lift the rear seat out of the way.



66

The electrical system depends mainly on the battery. Therefore, the battery should be checked regularly and kept in a good working condition.

Never drive the car with a disconnected battery as this may damage the electrical system.

Do not expose the battery to an open flame or electric spark. Hydrogen gas generated by the battery is explosive. Do not let battery acid come in contact with skin, eyes, fabric, or painted surfaces. Keep the battery out of reach of children.

Each filler plug has to be unscrewed to check the fluid level in each cell. If it is **below** the indicator, top it up with distilled water. **Only fill up to indicator.**

How often the battery has to be topped up depends mainly on operating conditions and on the time of year. As a general rule, the battery electrolyte level must be checked more often in the summer than in the winter, and more often when driving long distances.

The terminals and connections should be kept clean and greased with silicon spray or petroleum jelly. Make sure the ground connection to the body is free of corrosion and tight.

When working on the battery, be sure not to short circuit the terminals. This would cause the battery to heat up very quickly, which could lead to damage.

Before having a quick-charge performed on a battery installed in a car, **disconnect both terminals to avoid serious damage to the electronic components of the electrical equipment.**

If you have not used your car for an extended period of time, have the battery recharged.

Fuel supply

The engine requires "Regular" gasoline with a minimum octane rating of 91 (RON). In the interest of cleaner air, the VW engine is designed to run also on low-lead or lead-free gasoline. If regular fuels with adequate anti-knock qualities are not available, premium fuels should be used or mixed with the regular fuel.

When travelling outside the United States or Canada, regular gasolines may have a considerably lower octane rating. Therefore, make sure the gasoline that you are using does not have an octane rating lower than 91.

The Auxiliary Heater (optional equipment) must be turned off when filling the tank.

Never start or let the engine run in an enclosed unventilated area. Exhaust fumes from the engine contain carbon monoxide which is colorless and odorless. Carbon monoxide, however, is a very harmful gas, and can be fatal when inhaled.

The filler neck to the fuel tank is on the side panel above the right front fender. The flap opens if you pull the release on the right underneath the instrument panel.

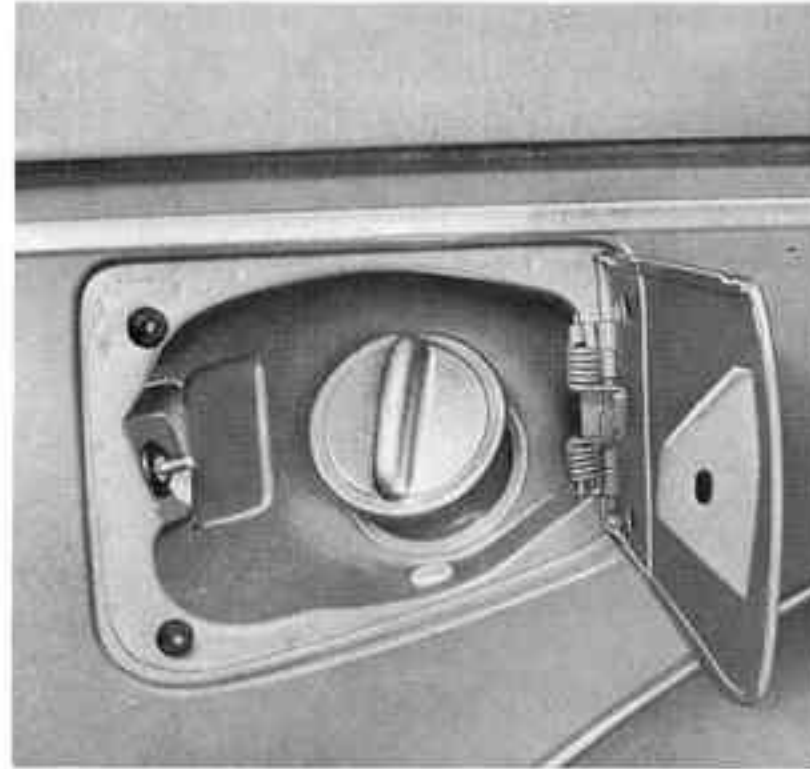

The fuel tank has a capacity of 11.1 US gallons (42 liters or 9.2 Imp. gal.). The VW 111 has a tank capacity of 10.6 US gallons (40 liters or 8.8 Imp. gal.).

When putting the cap back on, turn the threaded filler cap until you hear a click. On the VW 111, twist the cap to its stop.

Checking the engine oil level

Your 2W will usually not need additional oil between the scheduled changes.

Even so, you should check the oil level frequently and to time. To get a true reading, be certain the car is on level ground.

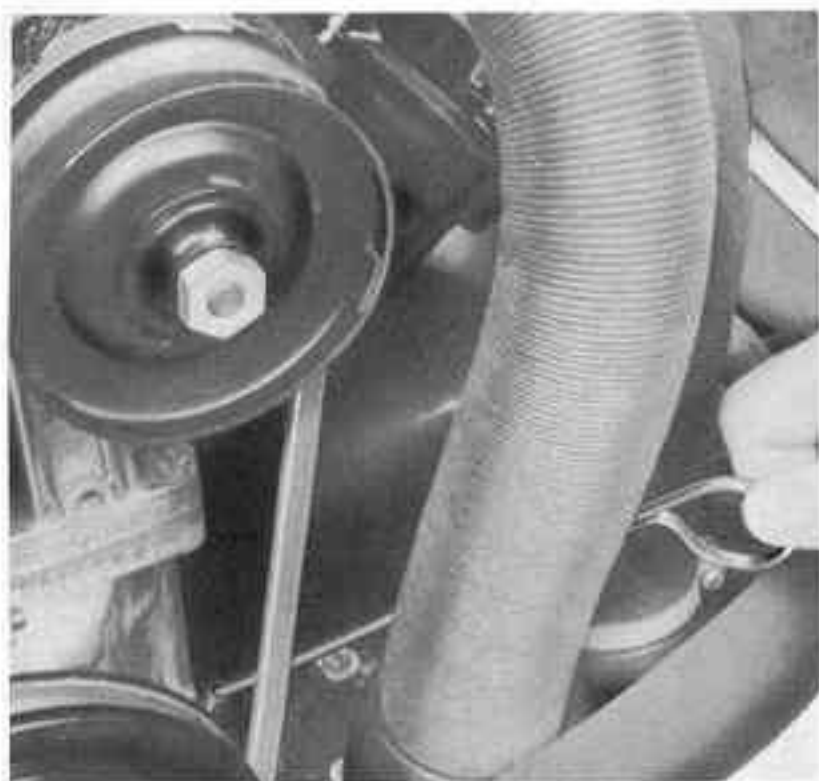

Wait at least 5 minutes after the engine has been stopped; give the oil time to collect in the crankcase.

To check the oil level, take the dipstick out and wipe it clean first. Now, insert and pull it out again. You have enough

oil in the engine if the oil level is between the upper and lower marks on the dipstick.

Only add the amount of oil that is needed.

Always select a well-known brand and the recommended grade. Details about the correct oil viscosities are on page 73.

Before working under the engine hood turn off the engine and let the engine cool down sufficiently. If work has to be done with the engine running, exercise extreme caution to prevent neckties, jewelry or long hair from getting caught in the V-belt.

Checking the ATF level

On vehicles with Automatic Stick Shift, the ATF in the torque converter does not have to be changed, but the level should be checked every 6,000 miles, with the engine turned off.

An ATF tank filler with a dipstick attached to its cover is provided for this purpose on the right side in the engine compartment.



Wipe the dipstick clean first before inserting it to take a level reading. The fluid level should be between the two marks on the dipstick, and should never fall below the lower mark. Only add the required amount of ATF. Check for leaks.

For ATF specifications, see page 74.

Removing and installing seats

Removing front seats

To protect the floor covering, put paper in the front footwell.

With the adjusting lever (1) raised, slide the seat all the way forward until the runner touches the leaf spring stop (2). Stand outside the car, depress the leaf

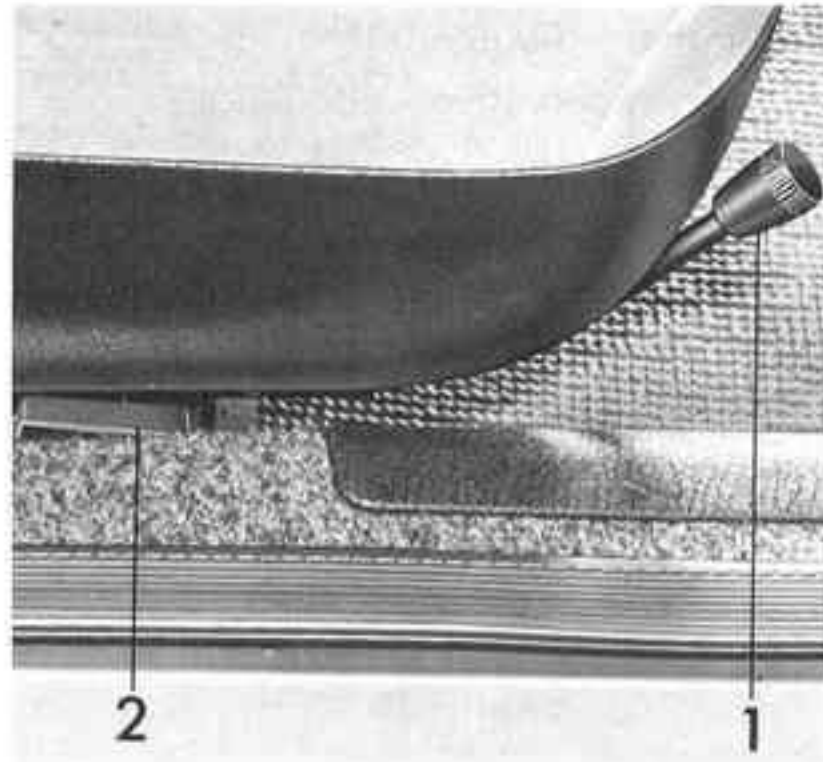

spring stop with a screwdriver and, with the adjusting lever raised, slide the seat forward approximately 1½ inch.

Reach under the seat to unhook the coil spring (3).

With the adjusting lever raised, slide the seat fully off the tracks and lift it out.

Reinstalling front seats

Stand outside the car, hold the seat with the backrest forward for better balance and position it in front of the tracks.

Hook the inboard seat runner on its track first. Then insert the outer runner by pulling the seat slightly toward you.

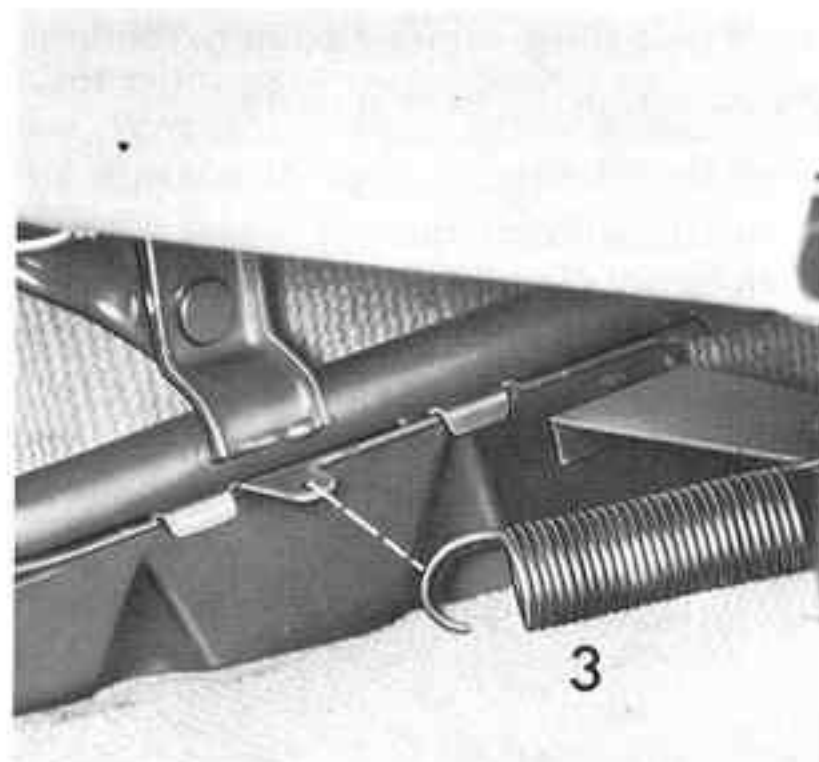

With the adjusting lever (1) raised, slide the seat back on the tracks and reconnect the coil spring.

Removing and installing rear seats

Raise the front end of the seat and pull it slightly toward you. Tilt it over rearward for easier removal.

To put the seat back in again, lift it into the car holding it diagonally. Place it on the front edge of the seat frame, and



with the front end tilted up, slide it fully back under the backrest. Press down the front edge (arrows) to firmly position the seat.

Position the safety belts on top of the seat cushion.

Cleaning your VW

The paint on your VW is very durable, and so is the upholstery. But a car can get a lot of abuse from industrial fumes and corrosive road salt to half-eaten lollipops and muddy dog feet.

A well-cared-for VW can look like new 10 years later. It all depends on the owner and the amount of care he is willing to give to his car.

Here are a few hints on how to keep your VW looking young and beautiful. We have also compiled a list of cleaning products. They are available at any VW Dealer.

Whenever using VW-recommended products or other cleaning agents, **follow the directions on the containers. Be aware of warning or caution labels.**

Application	Volkswagen Product
Car wash and liquid wax	Car Wash and Wax – ZVW 243 201
Paint preservative	Paint Preservative and Wax – 000096011
Paint waxing	Classic Car Wax – ZVW 246 101
Paint polishing and paint waxing	Combination Car Cleaner and Wax – ZVW 241 109
Paint polishing, remove paint oxidation	Paint Polish – 000096001
Preservation of chrome parts	Chrome Preservative – 000096067
Paint touch-up	Touch-Up Paint (all colors)
Convertible top cleaning, Upholstery cleaning, Whitewall tire cleaning	All Purpose Cleaner – ZVW 243 101
Windshield washer cleaning and anti-freeze	Windshield Washer Anti-Freeze & Solvent – ZVW 241 101

When cleaning upholstery and carpet, never use gasoline, kerosine, naphtha, nail polish remover or any other volatile solvents. They may be toxic or flammable and therefore hazardous. Keep all cleaning agents out of reach of children.

Washing your VW

The longer the dirt is left on the paint, the greater the risk of damaging the glossy finish, either by scratching if the dirt is rubbed into the paint, or simply by the chemical effect dirt particles have on the paint surface.

Therefore dirt should be washed off as soon as possible. NEVER WASH IN DIRECT SUNLIGHT.

Use plenty of water, a car-wash soap, such as VW's Car Wash and Wax, and a soft sponge or hose brush. Begin with spraying water over the dry car to remove all loose dirt before applying the lukewarm soap/water solution.

Use plenty of water to rinse the car off well. Wipe the car dry with a chamois to avoid water spots.

Waxing

Waxing is not really needed when you have washed your car with VW's Car Wash and Wax. If you do not use a car wash liquid with wax, apply Paint Preservative and Wax to preserve the natural shine of the car.

To obtain a long lasting wax finish apply hard wax, such as VW's Classic Car Wax, after eight to ten weeks after buying the car. Wax again when water remains on the surface in large patches instead of forming beads and rolling off.

Polishing

Use a polish such as VW's Paint Polish later in the car's life when the paint appears dull and loses its shine. **Do not polish the new car.**

Always apply wax after polishing.

Cleaning windows

Clean windows with a special glass cleaning water. Dry with a chamois.

Weatherstrips

To seal properly, weatherstrips around windows and doors must be pliable. To retain flexibility of the rubber, spray with silicone, available from your VW Dealer, or coat with talcum powder.

Windshield wiper blades

Remove the wiper blades periodically and scrub with a hard brush and alcohol or a strong detergent solution.

Chrome care

To protect the car's chrome, apply VW's Chrome Preservative.

Touch-up paint

Your dealer has touch-up paint for minor scratches and stone chips. Scratches should be touched up soon after they occur.

Care of chassis

The underside of the car picks up dirt and salt and should be sprayed with a powerful jet of water. This is easier to do after the car has been driven in rain.

Do not use gasoline, kerosene, naphtha, nail polish remover or other volatile cleaning fluids. They may be toxic or flammable or hazardous in other ways. Only use spot removing fluids in well ventilated areas. Keep them out of reach of children.

Removing spots

Tar

Do not permit tar to settle on the paint finish. Remove it early with a cloth soaked with a special paint cleaner, such as Paint Preservative and Wax. If you do not have a spot remover, you may substitute with turpentine. After applying a cleaning fluid, always wash with a lukewarm soap/water solution and apply a new wax coat.

Insects

Remove early with a lukewarm soap/water solution or apply insect remover.

Tree sap

Remove with a lukewarm soap/water solution. Do not permit tree sap to harden on the paint surface.

Cloth upholstery and carpet

Clean with a vacuum cleaner or a hard brush. Dirt spots can usually be removed with a lukewarm soap/water solution.

Use spot remover for grease and oil spots. Do not pour the liquid on the cloth material. Dampen a clean cloth and rub carefully, starting at the edge and working inwards.

Leatherette and interior trim

Use VW's All Purpose Cleaner or a dry foam cleaner.

Grease or paint spots can be removed by wiping with a cloth soaked with VW's All Purpose Cleaner. Leatherette parts of the headliner and side trim panels can be cleaned with a soft cloth or brush and All Purpose Cleaner.

Cleaning the convertible top

The top does not require any special care. Wash off dirt as soon as possible. **Do not wash in direct sunlight.** Use lukewarm water together with VW's All Purpose Cleaner. A hard brush will help to loosen dirt from the grained surface of the material. Avoid scratching the body of the car with the bristles.

To remove spots, use a stronger solution of VW's All Purpose Cleaner. Never use paint thinner, nail polish remover or similar agents as they may have adverse effects on the top material.

After cleaning and washing the top, rinse the car well with clear water.

Clean the **pivoted points of the top linkage** from time to time, and lubricate them lightly with a few drops of oil. Wipe off excessive oil to prevent oil from dripping on the top material.

Engine oil

Always use a name brand oil labeled "For Service MS" or "SD" for the engine of your Volkswagen.

Engine oils are graded according to their viscosity. The proper grade to be used in your engine depends on existing climatic or seasonal conditions.

The following table contains the grading for oils to be used in VW engines:

Tropical climate	Hot season		SAE 40
	Cool season		SAE 30
Moderate climate	Summer		
	Winter	At average outside temperature of above 5° F	
		At average outside temperatures not lower than —13° F	

If outside temperatures are continuously below —13° F use SAE 5 W*

* Avoid high speed long distance driving when using SAE 10 W or SAE 5 W if outside temperatures rise above the indicated limits.

As temperatures ranges of the different oil grades overlap, **brief** variations in outside temperatures are no cause for alarm. It is also permissible to mix oil of different viscosities if you find it necessary to add oil.

Temperature ranges of SAE grades

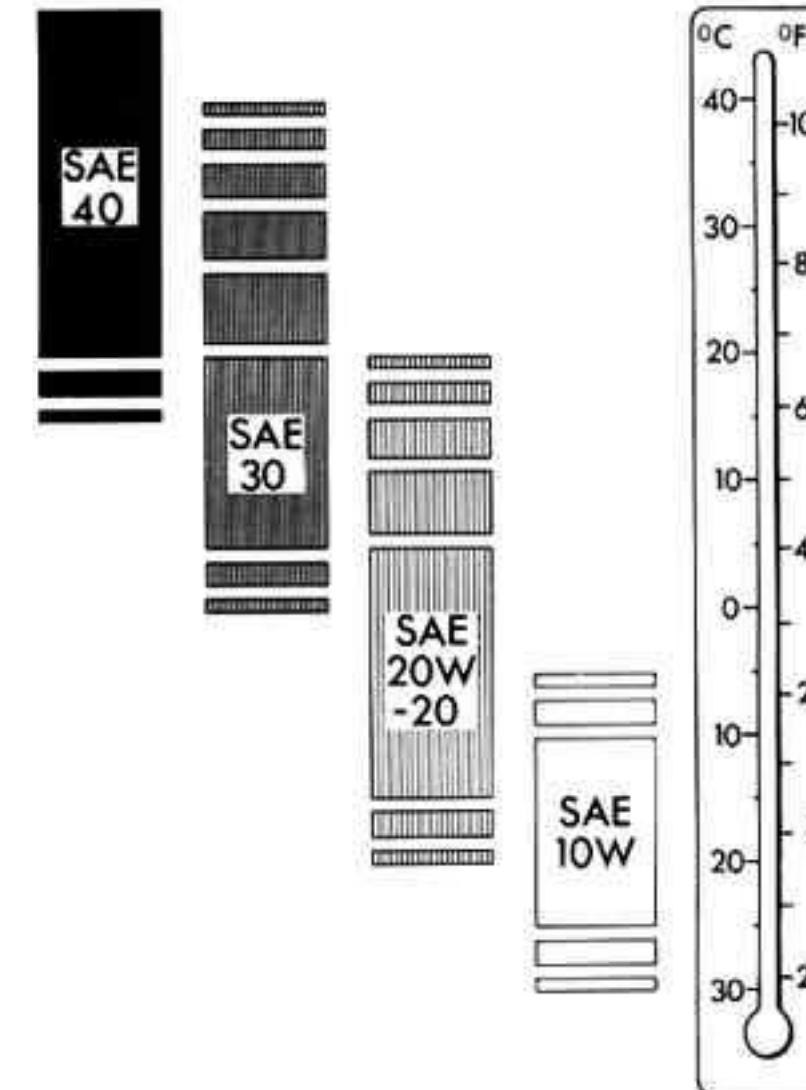

Transmission oil and Automatic Transmission Fluid (ATF)

Transmission and final drive are both lubricated with hypoid oil according to MIL-210-B specifications (additive basis: sulphur-phosphorus):

SAE 90 In general all year round.

SAE 50 In areas with cold climate.

ATF In areas with arctic climate and temperatures consistently below —13° F.

ATF is a special fluid for automatic transmissions, but ATF can also be used in the Manual Transmission under the above mentioned climatic conditions.

The torque converter of the Automatic Stick Shift requires ATF all year round.

All ATF's labeled "Dexron®" with a five-digit number preceded by the letter "B" can be used.

Lubricant additives

No additives should be mixed with fuel or lubricating oils and fluids.

Grease

- 1 – **Multi-purpose grease with a lithium base** should be used for the front axle of the Volkswagen Sedan 111 and for the door hinges on all beetle-type VW models.
- 2 – **Dry stick lubricant** should be used for the hood locks and the sliding surfaces of the striker plates.
- 3 – **Silicon spray or petroleum jelly** should be used for the battery terminals and posts.

Engine with Manual Transmission

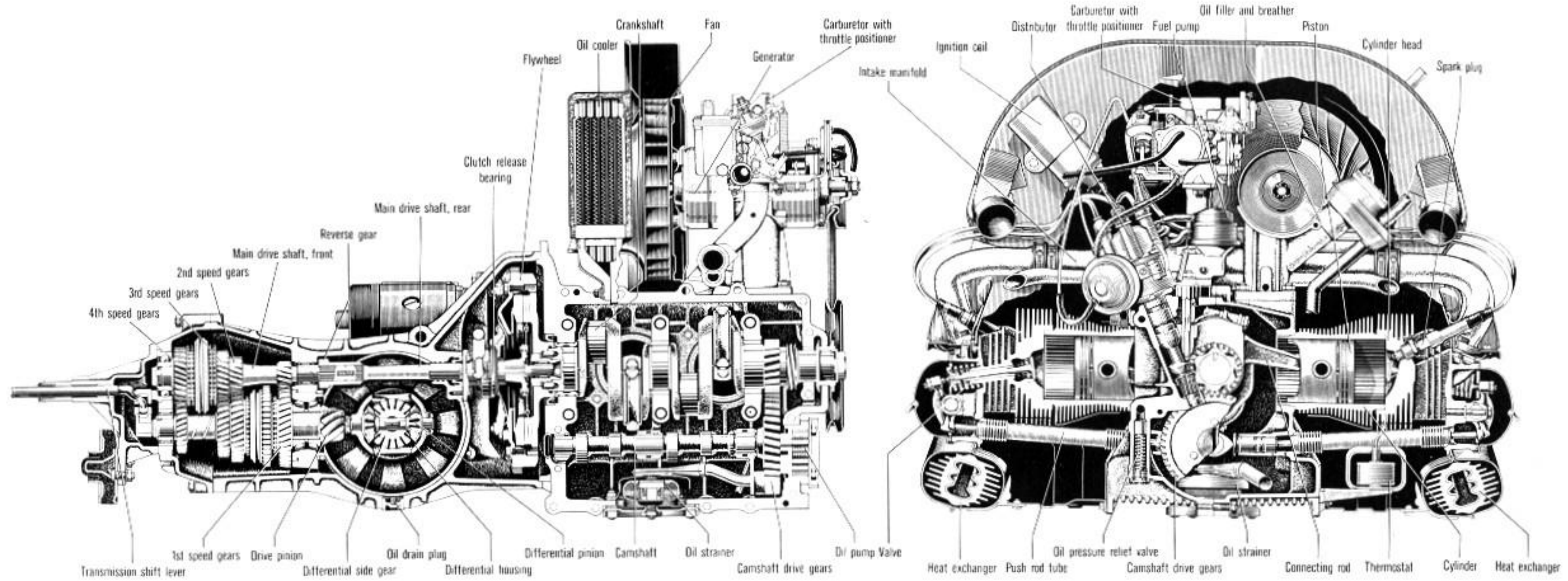

Authorized VW Dealers use a new service system specially developed for the VW.

Lots of service stations say they can repair Volkswagens and a lot of them really can.

But they cannot offer you VW Diagnosis and Maintenance – our new service system.

Instead of giving every VW the same basic maintenance, we now treat each one as an individual.

And we have already prepared your car for our even more advanced diagnosis system of the future. The plug in the upper left of the engine compartment is a part of this future.

Specially trained diagnosticians will check your VW directly using special testing equipment; that means your car gets just the maintenance it needs. No more, no less.

And you get a test report so you know the exact condition of your VW.

It tells you a lot about the car you drive.



Volkswagen Diagnosis and Maintenance

has been designed especially for today's Volkswagen and today's driving conditions.

Instead of giving every VW the same basic maintenance, we treat each one as an individual. (Because you are the driver. And you have your own individual driving habits.)

Here is how it works:

When you bring your VW in for service you will see the service adviser as usual. But your car won't go to the mechanic as usual. Instead it will be driven into a special diagnosis stall. One that is equipped with the very latest testing devices, especially designed for Volkswagen.

There, your VW will be tested by a specially trained Diagnostician.

He will check your car from bumper to bumper. He will analyze the engine. Check the wheel alignment, brakes, transmission. The lights, the battery, the tires. And many other items.

All in all, he will make dozens of tests.

And he will fill out a Test Report, like the one shown on the following two pages. You will get a copy of this Test Report. So you will know the condition of your VW.

If your VW is in good shape, you will know it. If any repairs or adjustments are required, you will know what needs to be done now, and what should be taken care of in the near future.

While your VW is at the dealership, your Volkswagen dealer can also perform the essential services, such as oil change, lubrication and other adjustments every VW requires.

The important thing is to bring your VW in for regular, periodic checkups.

So check the mileage chart on pages 83–91. Then keep an eye on your odometer. When your VW is due for service, bring it to your dealer. With VW Diagnosis and Maintenance, he can give your Volkswagen exactly the service it needs.

No more. No less.

Can you think of a better way?

Factory-recommended VW Maintenance

This Test Report tells you what work, if any, should be performed on your particular vehicle.

In addition, your Volkswagen should have VW Maintenance at specific mileages, as shown below.

This factory-recommended VW Maintenance can be done when your car is in for VW Diagnosis.

And it should be done. Every 6000 miles. To keep your VW running like a VW.

Every 6,000 miles

- Door and hood locks: Lubricate.
- Engine: Change oil and clean oil strainer.
- Front end: Lubricate.
- Air cleaner: Clean, if necessary, and fill lower part with oil.
- Valves: Check and adjust clearance.
- Distributor: Lubricate.
- Transmission and final drive: Check oil level.
- Automatic Stick Shift or vehicles equipped with automatic transmission: Check ATF level.
- Test Drive: Check braking, steering, heating, ventilation system and overall performance.
- Cylinder head covers: Check for leaks.

Every 12,000 miles

The 6,000 Mile Maintenance items are performed, plus the following services:

- Contact points: Replace, adjust dwell and timing with stroboscopic light.
- Spark Plugs: Replace.

Depending upon the model VW you own, there may be additional services required. See your VW Maintenance Record for details.

Keep this Test Report with your VW Maintenance Record. A pocket has been provided in the front cover for this purpose.



Volkswagen Diagnosis and Maintenance

Test report.

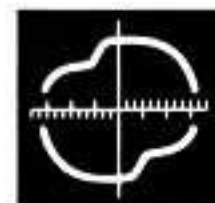

VW Diagnosis

We have noted the items that need to be adjusted, repaired or replaced, in addition to the factory-recommended maintenance listed in your Volkswagen Maintenance Record. Your Service Adviser will be glad to review the results of our diagnosis with you.

Engine and Clutch

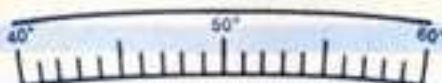
- Fan belt
- Distributor contact points
- Owall angle 
- Ignition timing
- Spark plugs Cylinders 1 2 3 4
- Compression
- Carburetor preheating flaps
- Throttle positioner or switch
- Crankcase ventilation
- Air intake flaps and bellows
- Exhaust system
- Clutch pedal free play
- Automatic stick shift servo rod clearance
- Automatic stick shift lever contacts
- Engine oil level (disregard if oil is changed)
- Engine oil leaks

Rear Axle and Transmission

- Axle boots or drive shaft boots
- Rear axle, final drive and transmission leaks
- Automatic transmission fluid leaks
- Shock absorbers left right

Compression Test

Cyl	Compression	Lbs./Sq. Inch
1		
2		
3		
4		
5		
6		

Front Axle and Steering

- Tie rods and tie rod ends
- Upper torsion arms and play
- King and link pins
- Ball joints upper left upper right
lower left lower right
- Steering damper
- Shock absorbers left right
- Steering gear play
- Steering gear box leaks
- Camber of front wheels +  -
- Toe-in/Toe out of front wheels 

Wheels, Brakes, Tires

- Brake system leaks and damages
 - Brake pedal stroke
 - Brake pedal free play
 - Hand brake adjustment
 - Brake fluid level
 - Brake linings or pads front rear
L R L R Spare
 - Tire condition
- (Tire pressures corrected as needed)

Electrical System

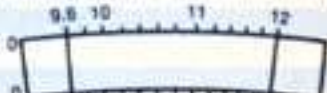
- Functioning of electrical equipment (headlights adjusted as needed)
- Cranking system
- Charging system
- Wiper blades
- Windshield washer
- Battery condition (electrolyte level corrected as needed)
- Battery voltage 

Test Drive

- Foot brake Hand brake Clutch Heating system

Repair Order No.:

Chassis No.:

Customer's Name:

© 1967 Volkswagen of America, Inc.

Date:

Diagnostician's Signature:

VW Maintenance & Repair Analysis

Operation No.	Description	Urgent	Estimated
	Factory-recommended VW Maintenance		
W MA1k	Adjust clutch free play		
W B1k	Adjust brakes		
W E62c	Replace points		
W E70c	Replace plugs	N/C	
W E836c	Replace wiper blades		

▲ = Urgently required

The above indicated maintenance and repair work is required on your vehicle to obtain the best performance and safe operation. Please indicate with your signature that the nature and importance of each listed item has been explained to you.

Customer's Signature:

This page was
originally left Blank

VW Diagnosis and Maintenance Record

The VW Diagnosis and Maintenance Service has been developed to give you maximum economy, dependability, safety and convenience. The Diagnosis and Maintenance Record, which appears on the following pages (pages 83–91) shows you at what mileage you should bring your car to your Authorized Volkswagen Dealer.

Naturally, this may not be the only maintenance your car needs, but you will know what additional maintenance is needed when you receive a copy of the VW Diagnosis Test Report. Just hand this Volkswagen Owner's Manual to your Authorized Volkswagen Dealer. He will do the rest.

Remember, from 6,000 miles onward, the VW Diagnosis and Maintenance service should be performed every 6,000 miles. Engine oil should be changed every 3,000 miles.

If your Volkswagen is driven less than 3,000 miles in three months, have the oil changed every three months; if driven less than 6,000 miles in twelve months, have the front end lubricated once a year (VW 111 only).

Of course, you can obtain a VW Diagnosis at any time – outside the regular schedule – at your Authorized Volkswagen Dealer. Especially if you drive less than 6,000 miles a year, we recommend you have a VW Diagnosis performed between regular mileage intervals.

Every Authorized Volkswagen Dealer at home or abroad will perform all the operations listed for VW Diagnosis, VW Maintenance, and the additional services (such as oil change, lubrication, brake fluid renewal, repacking of wheel bearings), in accordance with Volkswagen quality service standards.

To get you started, there is a booklet with VW Diagnosis Coupons in the back cover pocket of this manual.

The first of these coupons entitles you to a free maintenance and oil change service. The next four coupons enable you to obtain one free VW Diagnosis each. The remaining coupons serve as a reminder to bring your Volkswagen in for a VW Diagnosis and Maintenance at regular intervals.

The free coupons are not transferrable; they are only valid for **your** Volkswagen. Do not remove them from the coupon booklet which shows the chassis number of your car.

This page was
originally left Blank

Delivery Inspection 422  110 ENDRES MOTORS (Dealer Stamp) Lancaster, Calif. Date <u>03-24-72</u> Miles <u>00092</u>	600 miles	
Engine and Transmissior Oil Change (Dealer Stamp) Date _____ Miles _____	Free Maintenance Service (Dealer Stamp) Date _____ Miles _____	

3000 miles Oil Change Service (Dealer Stamp) Date _____ Miles _____	6000 miles Free Diagnosis 422  110 (Dealer Stamp) ENDRES MOTORS Lancaster, Ca. 93534 Date <u>6-2-72</u> Miles <u>6237</u>	6000 miles Maintenance 110 (Dealer Stamp) ENDRES MOTORS Lancaster, Ca. 93534 Date <u>6-1-72</u> Miles <u>6237</u>	9000 miles Oil Change Service 422  110 (Dealer Stamp) ENDRES MOTORS Lancaster, Ca. 93534 Date _____ Miles _____	12000 miles Free Diagnosis 422  110 (Dealer Stamp) ENDRES MOTORS Lancaster, Ca. 93534 Date <u>8-15-72</u> Miles <u>15237</u>	12000 miles Maintenance 110 (Dealer Stamp) ENDRES MOTORS Lancaster, Ca. 93534 Date _____ Miles <u>15237</u>
---	---	--	---	--	--

This page was
originally left Blank

15000 miles Oil Change Service (Dealer Stamp) ENDRES MOTORS Lancaster, Ca. 93534 Date <u>8-18-70</u> Miles <u>15239</u>	18000 miles Free Diagnosis (Dealer Stamp) Date <u>10-17-72</u> Miles <u>20844</u>	18000 miles Maintenance (Dealer Stamp) Date <u>10-17-72</u> Miles <u>20844</u>	21000 miles Oil Change Service (Dealer Stamp) Date <u>1/23/73</u> Miles _____	24000 miles Free Diagnosis (Dealer Stamp) ALEXANDER VOLKSWAGEN YUMA, ARIZONA Date <u>1/23/73</u> Miles <u>26741</u>	24000 miles Maintenance (Dealer Stamp) ALEXANDER VOLKSWAGEN YUMA, ARIZONA Date <u>1/23/73</u> Miles <u>26741</u>
27000 miles Oil Change Service (Dealer Stamp) Date _____ Miles _____	30000 miles Diagnosis (Dealer Stamp) Date _____ Miles _____	30000 miles Maintenance (Dealer Stamp) Date _____ Miles _____	33000 miles Oil Change Service (Dealer Stamp) Date _____ Miles _____	36000 miles Diagnosis (Dealer Stamp) Date _____ Miles _____	36000 miles Maintenance (Dealer Stamp) Date _____ Miles _____
39000 miles Oil Change Service (Dealer Stamp) Date _____ Miles _____	42000 miles Diagnosis (Dealer Stamp) Date _____ Miles _____	42000 miles Maintenance (Dealer Stamp) Date _____ Miles _____	45000 miles Oil Change Service (Dealer Stamp) Date _____ Miles _____	48000 miles Diagnosis (Dealer Stamp) Date _____ Miles _____	48000 miles Maintenance (Dealer Stamp) Date _____ Miles _____

This page was
originally left Blank

51 000 miles Oil Change Service (Dealer Stamp) Date _____ Miles _____	54 000 miles Diagnosis (Dealer Stamp) Date _____ Miles _____	54 000 miles Maintenance (Dealer Stamp) Date _____ Miles _____	57 000 miles Oil Change Service (Dealer Stamp) Date _____ Miles _____	60 000 miles Diagnosis (Dealer Stamp) Date _____ Miles _____	60 000 miles Maintenance (Dealer Stamp) Date _____ Miles _____
63 000 miles Oil Change Service (Dealer Stamp) Date _____ Miles _____	66 000 miles Diagnosis (Dealer Stamp) Date _____ Miles _____	66 000 miles Maintenance (Dealer Stamp) Date _____ Miles _____	69 000 miles Oil Change Service (Dealer Stamp) Date _____ Miles _____	72 000 miles Diagnosis (Dealer Stamp) Date _____ Miles _____	72 000 miles Maintenance (Dealer Stamp) Date _____ Miles _____
75 000 miles Oil Change Service (Dealer Stamp) Date _____ Miles _____	78 000 miles Diagnosis (Dealer Stamp) Date _____ Miles _____	78 000 miles Maintenance (Dealer Stamp) Date _____ Miles _____	81 000 miles Oil Change Service (Dealer Stamp) Date _____ Miles _____	84 000 miles Diagnosis (Dealer Stamp) Date _____ Miles _____	84 000 miles Maintenance (Dealer Stamp) Date _____ Miles _____

This page was
originally left Blank

<p>87 000 miles Oil Change Service</p> <p>(Dealer Stamp)</p> <p>Date _____</p> <p>Miles _____</p>	<p>90 000 miles Diagnosis</p> <p>(Dealer Stamp)</p> <p>Date _____</p> <p>Miles _____</p>	<p>90 000 miles Maintenance</p> <p>(Dealer Stamp)</p> <p>Date _____</p> <p>Miles _____</p>	<p>93 000 miles Oil Change Service</p> <p>(Dealer Stamp)</p> <p>Date _____</p> <p>Miles _____</p>	<p>96 000 miles Diagnosis</p> <p>(Dealer Stamp)</p> <p>Date _____</p> <p>Miles _____</p>	<p>99 000 miles Maintenance</p> <p>(Dealer Stamp)</p> <p>Date _____</p> <p>Miles _____</p>
<p>99 000 miles Oil Change Service</p> <p>(Dealer Stamp)</p> <p>Date _____</p> <p>Miles _____</p>	<p>100 000 miles Diagnosis</p> <p>(Dealer Stamp)</p> <p>Date _____</p> <p>Miles _____</p>	<p>100 000 miles Maintenance</p> <p>(Dealer Stamp)</p> <p>Date _____</p> <p>Miles _____</p>			

This page was
originally left Blank

Additional Services Record

The boxes on this page indicate services that are required in addition to the preceding Maintenance schedule.

Be sure to have all service items performed – at the recommended mileages or dates – by an Authorized Volkswagen Dealer.

It is the best way to keep your VW running. And running. And running.

30 000 miles	60 000 miles	90 000 miles
Repack front and rear wheel bearings	Repack front and rear wheel bearings	Repack front and rear wheel bearings
(Dealer Stamp)	(Dealer Stamp)	(Dealer Stamp)
Date _____	Date _____	Date _____
Miles _____	Miles _____	Miles _____

Brake Fluid Renewal and checking of brake warning light switch		
after 2 years of operation	after 4 years of operation	after 6 years of operation
(Dealer Stamp)	(Dealer Stamp)	(Dealer Stamp)
Date _____	Date _____	Date _____
Miles _____	Miles _____	Miles _____

This page was
originally left Blank

Oil Change and Maintenance Service 600 Miles

The free maintenance service at 600 miles consists of the following: (Lubricants, fluids and materials such as gaskets are paid by the customer).

Oil Change

- 1 – Engine: Change oil, clean oil strainer. Check for leaks.
- 2 – Transmission: Change oil, clean magnetic drain plugs. Check for leaks.

Maintenance Service

- 1 – V Belt: Check, adjust if necessary.
- 2 – Valve clearance: Check and adjust.
- 3 – Clutch pedal free play: Check and adjust.
- 4 – Rear axle: Check torque of bolts on constant velocity joints.
- 5 – Drive shafts: Check boots for leaks.
- 6 – Front axle: Check tie rod ends and tie rods.
- 7 – Tires and wheels: Check tire pressures, including spare wheel. Check wheel bolts, torque to factory specifications if necessary.
- 8 – Brake system: Check for damage and leaks. Check brake fluid level, add if necessary. Adjust foot and parking brakes.
- 9 – Electrical system: Check operation of all components, adjust headlights if necessary.

During roadtest:

Check efficiency of braking, steering, heating and ventilation systems. Check overall performance.

After roadtest:

Check and adjust idling. Check throttle positioner for correct functioning. Check cylinder head covers for leaks.

VW Diagnosis and VW Maintenance

Oil Change Service

The engine in the Volkswagen requires little oil. But for long engine life, this oil should be changed every 3,000 miles. An oil change at a VW dealer includes the services shown below:

- 1 – Engine: Change oil, clean oil strainer, check for leaks.
- 2 – Battery: Check, add distilled water if necessary. Clean and grease terminals.
- 3 – Windshield washer: Check fluid.

VW Diagnosis

A physical checkup of your VW is extremely important for determining the amount of additional maintenance your vehicle may need for continuing peak performance.

Listed on the following pages is the VW Diagnosis procedure which applies to your vehicle.

Chances are, if you have regularly maintained your vehicle, it is in good running condition.

The VW Diagnosis Test Report will be given to you so you will know the exact condition of your VW.

It is something you should know.

A VW Diagnosis every 6,000 miles consists of:

(only applicable operations on your vehicle will be performed)

Engine and clutch:

- 1 – V Belt: Check tension and condition.
- 2 – Ignition system: Check with electronic equipment.
- 3 – Compression: Check, including remove and install spark plugs. Note: Replace plugs at 12,000, 24,000, 36,000 miles etc.
- 4 – Throttle positioner: Check for correct functioning.
- 5 – Exhaust system: Check for damage.
- 6 – Manual transmission
Clutch: Check pedal free play.
- 7 – Automatic Stick Shift
Servo clutch rod: Check clearance.
- 8 – Automatic Stick Shift
Shift lever contacts: Check operation.
- 9 – Engine: Check engine oil level.
- 10 – Engine: Check for leaks.
- 11 – Idling: Check and adjust.

Rear axle and transmission:

- 12 – Drive shaft boots: Check for leaks.
- 13 – Rear axle, final drive and transmission: Check for leaks.
- 14 – Automatic Stick Shift
Fluid pan: Check torque of bolts.
- 15 – Automatic Stick Shift
Torque converter system: Check for leaks.
- 16 – Shock absorbers: Check for leaks and damage.

Front axle and steering:

- 16 – Front axle: Check dust seals and proper fit of plugs (VW 111 only) on ball joints, check dust seals on tie rod ends, check tie rods.
- 17 – Ball joints: Check play (VW 111 only).
- 18 – Steering: Check play.
- 19 – Front wheels: Check camber and toe.

Brakes, wheels, tires:

- 20 – Brakes: Check brake system for damage and leaks.
- 21 – Brake pedal: Check free play.
- 22 – Brake pedal: Check pedal travel.
- 23 – Parking brake: Check adjustment.
- 24 – Brake fluid: Check level.
- 25 – Brake linings or pads: Check thickness.

- 26 – Tires, including spare wheel: Check for wear and damage, check and correct pressure.
- 27 – Wheels: Check torque of mounting bolts.

Electrical system:

- 28 – Cranking system: Check with electronic equipment.
- 29 – Charging system: Check with electronic equipment.
- 30 – Check operation of headlights, parking lights, side marker lights, license plate light, interior light, emergency lights, ignition lock, buzzer alarm, stop lights, back-up lights, turn signal lights, horn instrument lights, fresh air fan, and warning lights for brakes, oil pressure, generator and rear window defogger.
- 31 – Headlights: Check and adjust.
- 32 – Windshield wiper: Check operation and blades.
- 33 – Windshield washer: Check operation and fluid.
- 34 – Battery: Check electrolyte level, add distilled water if necessary, check voltage under load.

Test Drive

Test drive if Diagnosis is not followed by maintenance or repair. If maintenance or repair follow the diagnosis, test drive after the job is completed.

Check braking, clutch, steering, heating, ventilation system and overall performance.

VW Maintenance

After your vehicle receives a VW Diagnosis, your Authorized Volkswagen Dealer can perform the VW Maintenance.

The maintenance which should be performed for every vehicle at specified mileage intervals is shown below.

There may be additional maintenance required which will show up on the VW Diagnosis Test Report.

Your VW Service Manager or Service Adviser will explain the results of the VW Diagnosis in detail.

This will help keep a small maintenance problem from growing into a big maintenance problem.

So that your VW will keep running like a VW.

A VW Maintenance every 6,000 miles consists of:

- 1 – Engine: Change oil, clean oil strainer.
- 2 – Air cleaner: Clean and refill lower part with oil.
- 3 – Valves: Check and adjust clearance.
- 4 – Front end: Lubricate (VW 111 only).
- 5 – Door hinges and door check: Lubricate.
- 6 – Transmission: Check oil level, add if necessary.
- 7 – Automatic Stick Shift
ATF level: Check, add if necessary.
- 8 – Automatic Stick Shift
Control valve: Clean air filter.
- 9 – Test drive: Check braking, clutch, steering, heating, ventilation system and overall performance. Cylinder head covers: Check for leaks.

In addition:

Every 12,000 miles

Contact points: Replace, including adjust dwell angle and timing with stroboscopic light.

Every 30,000 miles

- 1 – Front wheel bearings: Clean and repack.
- 2 – Rear wheel bearings: Clean and repack.
- 3 – Suspension strut ball joints: Check play (except VW 111).

Every 2 years

- 1 – Brakes: Replace brake fluid.
- 2 – Brake warning light switch: Check functioning.

In any authorized VW dealer's service department, you get VW Specialists who know VW's intimately.

A VW Specialist works on VW's. Period.

Every so often he takes time off and gets a refresher course at one of our VW training centers.

So he learns to fix Volkswagens before he starts working on your car. Rather than while he is working on your car.

We think it is better that way.

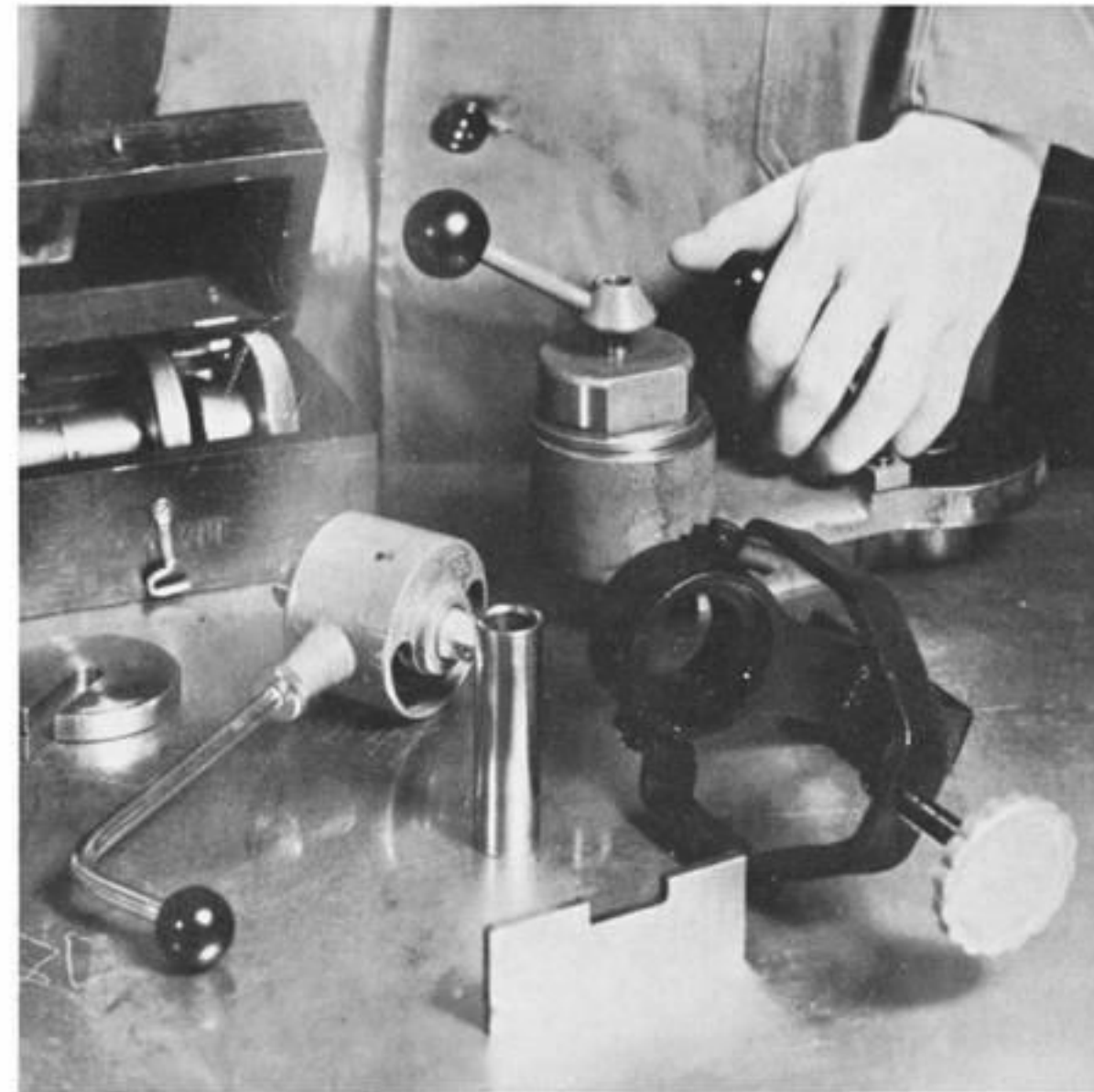

The “National Traffic & Motor Vehicle Safety Act of 1966” requires manufacturers to be in a position to contact vehicle owners if a correction of a product defect becomes necessary.

Please fill in one of the attached postcards if you change your address or purchase a Used Volkswagen.

You need not use this card if you purchased your car through an Authorized Volkswagen Dealer.

Please quote the VW chassis number as it appears on the identification plate of the vehicle. Its location is shown on page 15. Do not use the abbreviated serial number as shown on the vehicle registration.

Additional cards can be obtained from any Authorized Volkswagen Dealer.

NOTICE OF ADDRESS CHANGE**NOTICE OF USED CAR PURCHASE**

please check one of the above boxes

VW Chassis Number

Mo. Day Yr.

Last Name

First Name

Initial

Number

Street

City

State

Zip Code

Please print and give complete information.

Delivery Inspection

Checklist for _____
(chassis number)

Before Roadtest**Engine**

Oil level

Chassis

Wheel bolts

Tire pressures (including spare wheel)

Brake fluid reservoir

Brake lines and hoses

Steering components

Engine and transmission for leaks

Electrical system

Battery

Headlight dimmer switch

Ignition/steering lock

Headlight adjustment

Tail and stop lights

Licence plate light

Instrument lights

Turn signal and parking lights

Emergency flasher lights

Back-up lights

Horn

Windshield wipers and washer

Warning lights

Generator

Oil pressure

Turn signals

High beam

Brakes

Emergency flasher

BUSINESS REPLY MAIL

No Postage Stamp Necessary if Mailed in the United States

POSTAGE WILL BE PAID BY

VOLKSWAGEN of AMERICA, Inc.
818 Sylvan Avenue
Englewood Cliffs, N.J. 07632

FIRST CLASS
Permit No. 785
Englewood, N.J.
07631

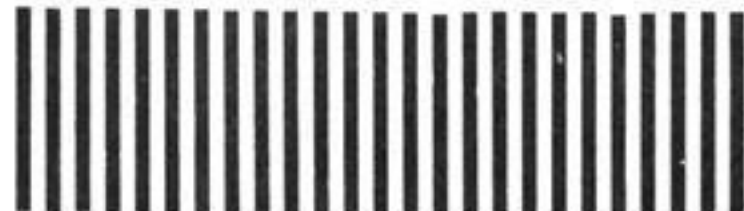

During Roadtest

- Foot and parking brake
- Gear shifting and clutch
- Windshield defroster
- Speedometer

After Roadtest

- Idling adjustment
- Operation of seat adjustment
- Safety belts
- Door locks
- Door hinges

Remarks: _____

Vehicle in perfect condition _____

(Signature of Service Adviser/Date)

NOTICE OF ADDRESS CHANGE

NOTICE OF USED CAR PURCHASE

please check one of the above boxes

VW Chassis Number

Mo. Day Yr.

Last Name

First Name

Initial

Number Street

City

State

Zip Code

Please print and give complete information.

NOTICE OF ADDRESS CHANGE

NOTICE OF USED CAR PURCHASE

please check one of the above boxes

VW Chassis Number

Mo. Day Yr.

Last Name

First Name

Initial

Number Street

City

State

Zip Code

Please print and give complete information.

BUSINESS REPLY MAIL

No Postage Stamp Necessary if Mailed in the United States

POSTAGE WILL BE PAID BY

VOLKSWAGEN of AMERICA, Inc.

818 Sylvan Avenue

Englewood Cliffs, N. J. 07632

FIRST CLASS

Permit No. 785

Englewood, N. J.

07631

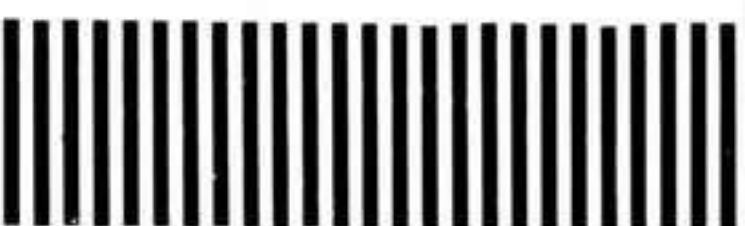

FIRST CLASS

Permit No. 785

Englewood, N. J.

07631

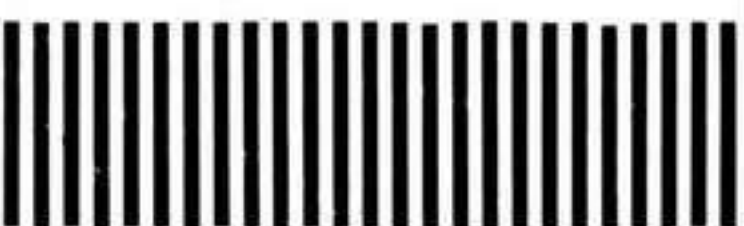

BUSINESS REPLY MAIL

No Postage Stamp Necessary if Mailed in the United States

POSTAGE WILL BE PAID BY

VOLKSWAGEN of AMERICA, Inc.

818 Sylvan Avenue

Englewood Cliffs, N. J. 07632

Index

- Acceleration 33, 34
- Address change cards 98
- Air conditioner 48
- Anti-freeze 53, 65, 70
- Ashtrays 38
- Automatic Stick Shift 34
- Automatic Transmission Fluid (ATF)
26, 30, 53, 68, 74
- Auxiliary heater 23, 50

- Back-up lights** 33
- Battery 66
- Brakes 25, 32
- Brake – fluid reservoir 65
– warning light 25
- Buzzer 16, 24

- Chassis – care** 71
– number 15
- Chrome care 71
- Cleaning 70
- Clutch pedal 32
- Coat hooks 37
- Convertible – top 46
– top cleaning 72

- Defogger, rear window** 23, 27
- Defogging and defrosting 43
- Diagnosis and Maintenance 77
 - Additional Service 91
 - Maintenance record 81
 - Test report 78

- Dimmer switch lever 23, 28
- Distributor addresses 106
- Driving ranges 34
- Doors 17

- Economical driving** 32, 35
- Emergency – equipment 52
– flasher 23, 24
- Engine – number 15
– type of oil 53, 73
– oil level 68
– sectional view 75

- Fan, fresh air** 23, 44
- Fuel – gauge 23, 26
– octane rating 67
– release for fuel tank flap 23, 67
– supply and tank 67

- Gearshifting** 33, 35
- Generator warning light 26, 30
- Glove compartment 23, 38
- Grease 74

- Headlight – switch** 23, 25
– dimmer 23, 28
- Heating/defrosting 23, 42
- High beam indicator light 26, 28
- Horn 23
- Hood, front 39

- Identification plate 15
- Ignition/steering lock 23, 24
- Instrument – illumination 25
– panel 22
- Interior light 37

- Jack** 59
- Jack ports 60,63

- Keys** 16

- Lane changer** 28
- Leatherette cleaning 72
- License plate light 25
- Lights 23, 25
- Locking device 17
- Locks 17, 38, 52
- Lubricants 74
- Luggage compartments 39

- Manual Transmission** 32
- Maintenance, Diagnosis and 77

- Neutral** 34, 36

- Octane rating** 67
- Odometer 26
- Oil – type 73
– pressure warning light 26, 30
- Owner relations 105

Parking 33
Parking – brake 33
– lights 25
Polishing 71

Radio aperture 23
Rear view mirrors 31
Rear window defogger 27
Reverse 33, 35

Safe driving hints 13
Safety belts 20
Safety compliance sticker 14
Seats – front 18, 69
– rear 69
Shifting – Manual Transmission 33
– Automatic Stick Shift 35
Side marker lights 25
Sliding roof 46
Spare tire 55, 58
Spark plugs 53
Speedometer 23, 26
Speed ranges 33
Spot removing 72
Starting 24, 36
Straps, assist 37
Studded tires 57
Summer starting 36
Sunroof 46
Sun visors 37

Tail light 25
Tires and pressures 54
– torque adjustment 55, 64
Touch-up 70, 71
Towing 51
Trailer hauling 51
Transmission – Manual 32
– Automatic Stick Shift 34
– oil 74
Turn signals 23, 28

V-belt 30
Vanity mirror 37
Ventilation 44

Warranty 7
Waxing 71
Weatherstrips 71
Wheel – balancing 55
– changing 60
Windows 18
Windshield – washer 23, 28, 53, 65
– wipers 23, 28
Winter – operation 52
– starting 36

